



# Vale of Aylesbury Local Plan

## Design

### Supplementary Planning Document





# Contents

<b>1</b>	<b>Purpose of the Design SPD</b>	<b>5</b>	<b>5.6</b>	<b>Pedestrian friendly streets / street hierarchy</b>	<b>92</b>
1.1	Overall objectives	6	5.7	Parking	94
1.2	How to use the Design SPD	7	5.8	Design for cyclists	98
1.3	Opportunities and constraints	14	5.9	Layout of commercial areas and infrastructure	100
1.4	The value of good design	16	5.10	Refuse, storage and utilities	102
1.5	High quality design and innovation	17	5.11	Open space, public realm and water space	104
<b>2</b>	<b>Design process</b>	<b>19</b>	<b>6</b>	<b>High quality and sustainable building design</b>	<b>117</b>
2.1	The design process	20	6.1	Deliver sense of place	118
2.2	Who to talk to	22	6.2	Architectural integrity	128
<b>3</b>	<b>Understanding the context</b>	<b>25</b>	6.3	Residential amenity and privacy	136
3.1	Introduction	26	6.4	Commercial buildings	139
3.2	Overview of the area	27	6.5	Sustainable buildings	140
3.3	Landscape character	34	<b>7</b>	<b>Development in the countryside</b>	<b>151</b>
3.4	Ecology	39	7.1	Responding to the landscape	152
3.5	Settlement character	41	7.2	Building design in rural areas	156
3.6	Aylesbury Garden Town	45	<b>8</b>	<b>Household extensions</b>	<b>163</b>
3.7	Local vernacular and distinctiveness	48	8.1	Introduction	164
3.8	Character study	52	8.2	Responding to local character and neighbours	165
3.9	Site appraisal	53	8.3	Scale, form and massing	166
<b>4</b>	<b>Establishing the structure</b>	<b>59</b>	8.4	Detailed principles	170
4.1	Natural resources	60	<b>9</b>	<b>Building conversions</b>	<b>177</b>
4.2	Movement network	69	9.1	Agricultural building conversions	178
4.3	Existing townscape and heritage	72	9.2	Conversion of chapels, schools and churches	185
<b>5</b>	<b>Site layout, streets and spaces</b>	<b>79</b>	9.3	Commercial building conversions	187
5.1	Inclusive and sustainable design	80			
5.2	Urban structure and sense of place	81		Appendix A National Design Guide	191
5.3	Mix of uses	85		Appendix B Landscape character typologies	195
5.4	Density, scale and massing	88		Appendix C Glossary	209
5.5	Legibility and image	90			



# 1

## Purpose of the Design SPD

The aim of the Design SPD is to ensure that new development across Aylesbury Vale is of the highest quality and that it responds appropriately to its context and is inclusive and sustainable. The Design SPD sets out clear principles and objectives that aim to inspire developers and designers and assist landowners, developers, applicants and planners in the process of delivering high quality and well designed development.

Over the Plan period the area will see significant growth and new development should be of a quality that contributes to the success of settlements, to a strong local economy and benefits existing residents, visitors and future generations. The Design SPD highlights the importance of a robust design process and careful consideration of context to create sustainable, successful, well-used places.

A key aim of this Design SPD is to help deliver a low carbon and climate resilient future for the area through well-designed sustainable buildings and high-quality local environments suitable for low-carbon living while respecting the heritage, character and ecology of the plan area.



# 1. Purpose of the Design SPD

## Objectives

### 1.1 Overall objectives

1.1.1 The National Planning Policy Framework (NPPF) makes clear that creating high quality buildings and places is fundamental to what the planning and development process should achieve.

1.1.2 In October 2019 the Government published the National Design Guide in order to illustrate how well-designed places that are beautiful, enduring and successful can be achieved in practice. It outlines this in the form of ten characteristics that contribute to good design. The National Design Guide recognises, however, that specific, detailed and measurable criteria for good design are most appropriately set out at the local level.

1.1.3 The Vale of Aylesbury Local Plan (VALP) sets out a vision and framework for sustainable growth across the area for the period up to 2033. It promotes new development to meet identified needs and which will contribute to creating a thriving, diverse, safe, vibrant place to live, work and visit where all residents enjoy a high quality of life.

1.1.4 VALP promotes growth that is shaped by strong place-shaping and sustainability principles to create well-designed developments that are sensitive to the area's local character and heritage and well integrated with existing communities, both in terms of scale, land-use and design.

1.1.5 The council is committed to achieving high design quality and local distinctiveness in new development and in creating desirable places and exemplar buildings, that will be appreciated by future generations.



1.1.6 This Supplementary Planning Document (SPD) is intended to inform and guide the quality of design for all development across the area. Whilst an important focus is large urban extensions, it is equally important in guiding the design of proposals for a single house, for a household extension or building conversion.

1.1.7 The Design SPD puts forward principles and standards for new development that aim to create safe and attractive places that are sensitive to, and maintain or enhance, Aylesbury Vale's special character, while also allowing creative and innovative design solutions.

1.1.8 High quality design is essential to optimise the development potential of sites and also to deliver the kind of places that will provide economic and environmental well-being and quality of life for the area's residents, both now and into the future.

1.1.9 This Design SPD provides a design-led approach to development. This follows the direction set out in the NPPF, the National Design Guide and VALP Policy BE2 – Design of new development.



#### **VALP POLICY BE2: Design of new development**

All new development proposals shall respect and complement the following criteria:

- a) The physical characteristics of the site and its surroundings including the scale and context of the site and its setting;
- b) The local distinctiveness and vernacular character of the locality, in terms of ordering, form, proportions, architectural detailing and materials;
- c) The natural qualities and features of the area; and
- d) The effect on important public views and skylines.

More guidance on the detail for the application and implementation of this policy will be provided in the District Design SPD.

## 1.2 How to use the Design SPD

1.2.1 This Design SPD is intended for frequent reference and will be essential for anyone charged with preparing or assessing the quality of planning applications including:

- Developers and builders, in considering potential development proposals;
- Householders, considering residential extensions;
- Design professionals, in drawing up schemes for development;
- Plan making town and parish councils, statutory and non-statutory consultees and the public in commenting on planning applications; and
- The council, in determining planning applications and in informing decisions at planning appeals.

1.2.2 The Design SPD consists of design principles (highlighted throughout the document) that development should adhere to. This is accompanied by descriptive text, illustrations and photographs of best practice examples including case studies from both within the area and elsewhere. Poor practice is also illustrated. Where appropriate reference to VALP policy is made.

1.2.3 The SPD is laid out in a consistent manner in each section for ease of use. A typical page is indicated in Figure 1.1.

Section title	Design Principle	Reference to VALP Policy
<h2>5. Site layout, streets and spaces</h2>	<h3>Legibility and image</h3>	VALP Policy Ref: BE2
<h3>5.5 Legibility and image</h3>	<p><b>Principle DES24: Use markers, landmarks, vistas and street hierarchy to aid legibility</b></p>	
<p>Development should seek to enhance legibility through a layout that responds to existing landscape features (including trees), structures or buildings or through the careful location of new features or buildings to act as markers or landmarks. For larger schemes development should be laid out with a clear street hierarchy that allows users to easily distinguish main streets from secondary and minor routes.</p>	<p><b>Reason</b></p>	<p>Figure 5.16: INDICATIVE SITE CONCEPT PLAN 11 - Enhancing legibility</p>
<p>5.5.1 Landscape features including trees, structures or special buildings can help to add distinctiveness to a place and act as visual cues to aid legibility and understanding.</p>	<p>5.5.2 Streets that create a varied sequence of spaces and vistas aligned with focal buildings can be more rewarding and contribute to the understanding of a place. This can be achieved through:</p>	<p>5.5.3 Buildings marking an important place or location in the townscape may be a little taller than the surrounding context but this increase in height must be proportionate to the role that they play in the streetscape.</p>
<ul style="list-style-type: none"> <li>• A curve or kink in the street;</li> <li>• Off-setting the street network and terminating the view on a building;</li> <li>• Creating a pinch point; and/or</li> <li>• Locating a taller building to terminate an axial view.</li> </ul>		<p>Marking a prominent street corner through roofscape and additional height</p>
90	Aylesbury Vale Design SPD	<p>Descriptive text providing reason and further explanation of the Principle</p>
<p>Illustration of design principle</p>	<p>Photograph of best practice (some pages also include photographs of things to avoid)</p>	

Figure 1.1: Typical page layout

### Structure of the SPD

1.2.4 The Design SPD is structured in nine chapters. The early chapters are set out in the sequence in which designers are expected to prepare their proposals. Refer also to the flowchart (Figure 2.1) in Section 2.1 - the design process. Later chapters focus on development in the countryside (Chapter 7) and on household extensions (Chapter 8) and building conversions (Chapter 9).

1.2.5 Each chapter is structured around a number of design principles that are required to be followed when designing and promoting new development within Aylesbury Vale. The principles are drawn from best practice (see additional resources below), respond to the unique environment within the area and are intended to guide and assist applicants on the design aspects that must be considered and addressed when drawing up their proposals.

1.2.6 This Design SPD provides general guidance on the form that new development should take. This addresses a range of development types including:

- New urban extensions and large residential developments;
- Brownfield and urban infill sites;
- Employment and commercial sites;
- New dwelling design;
- Household extensions; and
- Building conversions.

1.2.7 Not all principles will be relevant for smaller scale development proposals (including for single dwellings, household extensions or building conversions). Some elements, are most relevant for larger sites which must establish their own structure, either as part of an existing settlement or as an extension to an existing settlement.

1.2.8 Figures 1.2 to 1.6 list the design principles and identify the development types to which each is relevant. This is presented in the form of a number of table over five pages. The tables also indicate the relationship between the design principles and the ten National Design Guide characteristics (refer to Appendix A - National Design Guide).

### Checklists

1.2.9 Checklists are provided at the end of each chapter. The checklists are intended to act as prompts to applicants to ensure that the issues raised are considered at the right stage of the design process and to optimise the potential of the site to accommodate appropriate development.

1.2.10 Not all checklists or all the issues raised in individual checklists will apply to every site and each case will be decided on its merits.

1.2.11 Applicants are expected to demonstrate compliance where checklists do apply or robustly justify their proposals where a different approach has been taken.

#### Additional resources:

- National Design Guide
- National Model Design Code
- Building for a Healthy Life design toolkit
- Living with Beauty
- Urban Design Compendium 2



# 1. Purpose of the Design SPD

## Design principles matrix

Design SPD Chapter	Page	Design Principles	National Design Guide Characteristic	Development types									
				Strategic housing developments / urban extensions (300+ homes)	Major residential development (10 - 300 dwellings)	Smaller residential proposals (2-9 homes)	Brownfield and urban infill	Commercial or employment	Mixed use scheme	Individual houses within settlements	Individual houses in rural settings	Household extensions	Building conversions
<b>3. Understanding the context</b>	28	DES1: Designations	1	●	●	●	●	●	●	●	●	●	●
	36	DES2: Landscape character	1	●	●	●	●		●		●		
	39	DES3: Ecology	1, 2, 5	●	●	●	●	●	●	●	●	●	●
	42	DES4: Settlement and site context	1	●	●	●	●	●	●	●	●	●	●
	47	DES5: Aylesbury Garden Town	1	●	●	●	●	●	●	●	●	●	●
	48	DES6: Responding to local vernacular and distinctiveness	1, 2	●	●	●	●	●	●	●	●	●	●
	52	DES7: Character Study	1, 2	●	●	●	●	●	●	●	●	●	●
	53	DES8: Site Appraisal	1	●	●	●	●	●	●	●	●	●	●
<b>4. Establishing the structure</b>	60	DES9: Work with the natural features and resources of the site	1, 2, 5, 9	●	●	●	●	●	●	●	●		
	62	DES10: Respond to topography and strategic views	1, 2, 5, 9	●	●	●	●	●	●				
	63	DES11: Establish a landscape and green infrastructure network	2, 5, 9, 10	●	●	●	●	●	●				
	65	DES12: Water features and sustainable drainage systems	2, 5, 9, 10	●	●	●	●	●	●				
	67	DES13: Design to enhance biodiversity	5, 9, 10	●	●	●	●	●	●	●	●	●	●
	69	DES14: Establish a clear movement network that connects with the surrounding area	1, 4, 10	●	●	●	●	●	●				
	70	DES15: Reduce reliance on the private car	4, 9, 10	●	●	●	●	●	●				
	71	DES16: Anticipate future development	4, 10	●	●	●	●	●	●				
	72	DES17: Respond to the existing townscape, heritage assets, historic landscapes / archaeology	2, 9, 10	●	●	●	●	●	●	●			

Figure 1.2: Table setting out the structure of the Design SPD, the design principles and the type of developments to which they are applicable and relationship with National Design Guide (part 1)

# 1. Purpose of the Design SPD

## Design principles matrix

Design SPD Chapter	Page	Design Principles	National Design Guide Characteristic	Development types										
				Strategic housing developments / urban extensions (300+ homes)	Major residential development (10 - 300 dwellings)	Smaller residential proposals (2-9 homes)	Brownfield and urban infill	Commercial or employment	Mixed use scheme	Individual houses within settlements	Individual houses in rural settings	Household extensions	Building conversions	
5. Site layout, streets and spaces	80	DES18: Design for everyone and look to the future	9, 10	●	●	●	●	●	●	●	●	●	●	●
	81	DES19: Deliver a clear structure of streets and spaces that is easy to understand and move through	4, 6	●	●	●	●		●					
	83	DES20: Provide enclosure and positive frontage to streets	3, 4	●	●	●	●		●	●	●			
	85	DES21: Promote a mix of uses within larger schemes to provide services to meet local needs, conveniently located where they are most accessible	7	●					●					
	85	DES22: Provide a mix of residential typologies within residential schemes to create mixed communities and ensure these are adaptable to change	7, 8, 10	●	●	●	●		●					
	88	DES23: Ensure that development density and the scale and massing of proposed buildings responds to the existing and emerging character and context of an area	1, 2, 3	●	●	●	●		●					
	90	DES24: Use markers, landmarks, vistas and street hierarchy to aid legibility	2	●	●	●	●		●					
	91	DES25: Create a positive development edge	3, 5	●	●									
	92	DES26: Provide attractive streets and spaces defined by buildings rather than the highway, that encourage low speeds and that are safe to use by everyone	3, 4, 9, 10	●	●	●	●		●					
	94	DES27: Integrate parking to meet needs and support attractive streets and spaces	4, 6, 8	●	●	●	●	●	●	●	●			
	98	DES28: Plan for cyclists	4, 9, 10	●	●	●	●		●					
	100	DES29: Deliver attractive and efficient employment areas and infrastructure	7, 9	●	●	●	●	●	●					
	102	DES30: Consider and allow for servicing, refuse collection and deliveries	8, 9	●	●	●	●	●	●	●	●			
	103	DES31: Integrate refuse and recycling into the design of new development	8, 9	●	●	●	●	●	●	●	●			
	103	DES32: Plan for and integrate sub-stations, utilities and pump stations into the design of new development	3, 8, 9	●	●	●	●		●					

Figure 1.3: Table setting out the structure of the Design SPD, the design principles and the type of developments to which they are applicable and relationship with National Design Guide (part 2)

# 1. Purpose of the Design SPD

## Design principles matrix

Design SPD Chapter	Page	Design Principles	National Design Guide Characteristic	Development types										
				Strategic housing developments / urban extensions (300+ homes)	Major residential development (10 - 300 dwellings)	Smaller residential proposals (2-9 homes)	Brownfield and urban infill	Commercial or employment	Mixed use scheme	Individual houses within settlements	Individual houses in rural settings	Household extensions	Building conversions	
<b>5. Site layout, streets and spaces</b>	104	DES33: Enhance the environment and sense of place through open spaces	5, 6	●	●	●	●		●					
	106	DES34: Integrate space for play into the design	6	●	●	●	●		●					
	107	DES35: Enhance the environment and sense of place through tree planting and soft landscape	5, 6, 9	●	●	●	●		●					
	110	DES36: Deliver a high quality, coordinated and attractive public realm that is easy to manage and maintain	6, 9, 10	●	●	●	●		●					
	112	DES37: Provide a positive response to waterways	6, 9, 10	●	●	●	●	●	●					
<b>6. High quality and sustainable building design</b>	118	DES38: Promote high quality buildings that respond to their location and deliver a sense of place	2, 3, 8	●	●	●	●		●	●	●			
	124	DES39: Promote buildings that respond to and help to animate the street space	3, 6	●	●	●	●		●	●	●			
	128	DES40: Promote buildings that have architectural integrity utilising high quality materials and detailing	8, 9, 10	●	●	●	●		●	●	●			
	135	DES41: Consider the location and design of utility meters and external pipes so that they don't adversely impact the quality of development	8, 9, 10	●	●	●	●		●	●	●			
	136	DES42: New development must be designed to respect the privacy of existing residents	8, 9	●	●	●	●		●	●	●			
	137	DES43: Provide attractive and usable external amenity space for all homes	6	●	●	●	●		●	●	●			
	138	DES44: Homes should be designed to receive adequate daylight and sunlight and to avoid overshadowing	8, 9	●	●	●	●		●	●	●			
	138	DES45: Design to minimise the impacts of noise, air and light pollution	8, 9	●	●	●	●		●	●	●			
	139	DES46: Commercial buildings	8, 9					●						
	140	DES47: Minimise environmental impact by energy efficient and sustainable design	9, 10	●	●	●	●	●	●	●	●	●	●	●

Figure 1.4: Table setting out the structure of the Design SPD, the design principles and the type of developments to which they are applicable and relationship with National Design Guide (part 3)

# 1. Purpose of the Design SPD

## Design principles matrix

Design SPD Chapter	Page	Design Principles	National Design Guide Characteristic	Development types									
				Strategic housing developments / urban extensions (300+ homes)	Major residential development (10 - 300 dwellings)	Smaller residential proposals (2-9 homes)	Brownfield and urban infill	Commercial or employment	Mixed use scheme	Individual houses within settlements	Individual houses in rural settings	Household extensions	Building conversions
<b>6. High quality and sustainable building design</b>	141	DES48: Living roofs and walls	9, 10	●	●	●	●	●	●	●	●	●	●
	144	DES49: Sustainable building materials	9, 10	●	●	●	●	●	●	●	●	●	●
	145	DES50: Local energy production	9, 10	●	●	●	●	●	●	●	●	●	●
	146	DES51: Reducing water demand	9, 10	●	●	●	●	●	●	●	●	●	●
<b>7. Development in the countryside</b>	152	DES52: Respond to the landscape setting	1, 2								●		
	156	DES53: Residential buildings	8								●		
	158	DES54: Rural boundary treatments	1, 2								●		
	159	DES55: Agricultural and equestrian buildings	1, 2					●					

Figure 1.5: Table setting out the structure of the Design SPD, the design principles and the type of developments to which they are applicable and relationship with National Design Guide (part 4)

# 1. Purpose of the Design SPD

## Design principles matrix

Design SPD Chapter	Page	Design Principles	National Design Guide Characteristic	Development types											
				Strategic housing developments / urban extensions (300+ homes)	Major residential development (10 - 300 dwellings)	Smaller residential proposals (2-9 homes)	Brownfield and urban infill	Commercial or employment	Mixed use scheme	Individual houses within settlements	Individual houses in rural settings	Household extensions	Building conversions		
8. Household extensions	165	DES56: Responding to local character	1, 2											●	
	165	DES57: Consider your neighbours	8											●	
	166	DES58: Scale and massing	2, 8											●	
	168	DES59: Respond to the design of the original dwelling	2, 8											●	
	170	DES60: Side extensions	2, 8											●	
	171	DES61: Front extensions, canopies and porches	2, 8											●	
	172	DES62: Rear extensions	2, 8											●	
	173	DES63: Loft conversions and roof extensions	2, 8											●	
	174	DES64: Car parking and garages	2, 8											●	
9. Building conversions	178	DES65: Conversion of traditional agricultural buildings	2, 9, 10												●
	183	DES66: The curtilage of an agricultural conversion should respond to its rural context	2, 9, 10												●
	185	DES67: Conversion of chapels, schools and churches	2, 9, 10												●
	187	DES68: Conversion of commercial buildings	2, 9, 10												●

Figure 1.6: Table setting out the structure of the Design SPD, the design principles and the type of developments to which they are applicable and relationship with National Design Guide (part 5)

# 1. Purpose of the Design SPD

## The opportunity

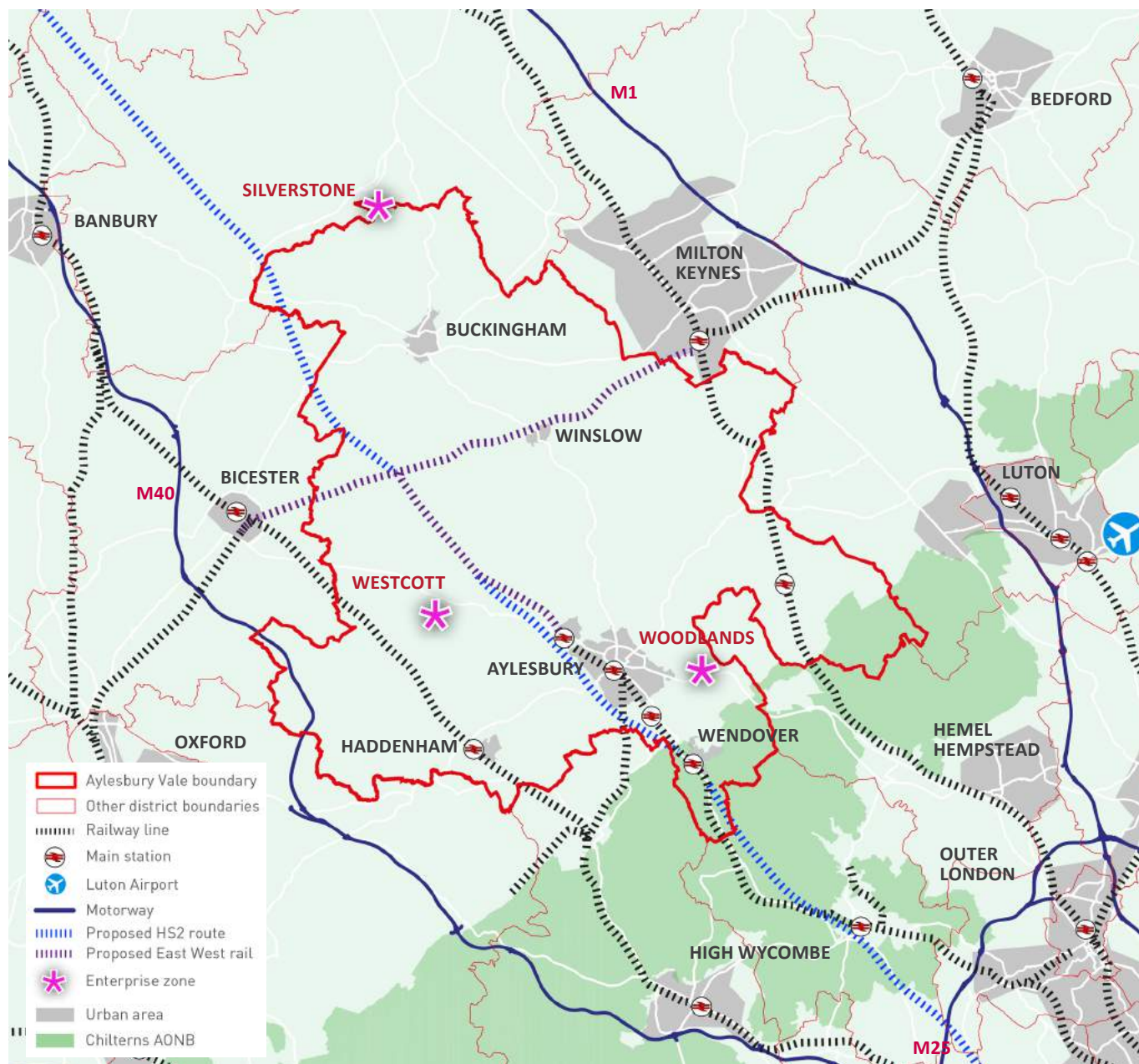

Figure 1.7: Aylesbury Vale context plan

### 1.3 Opportunities and constraints

1.3.1 Aylesbury Vale is a rural area set in beautiful countryside and benefiting from good access to London. The south-eastern part of the area is set within the Chilterns Area of Outstanding Natural Beauty (AONB) and almost a third is locally designated landscape.

1.3.2 The area is located between the M40 and M1 motorways and with Oxford, Banbury and Bicester to the west and Milton Keynes to the east but despite its proximity to London many parts of the area are sparsely populated and experience 'dark skies' at night.

1.3.3 Aylesbury is by far the largest settlement within the area, with over 40% of the population living there. It is also the county town of Buckinghamshire. Aylesbury was awarded Garden Town status by the Government in January 2017. The area has over 80 other settlements of varying sizes with Buckingham, Haddenham, Wendover and Winslow the largest and each providing local facilities that serve the surrounding rural areas. Many of the settlements in the area are attractive and historic.

1.3.4 Aylesbury Vale is experiencing pressure for growth with the VALP setting a housing provision of over 30,000 homes in the period up to 2033 to meet the needs of Aylesbury Vale as well as unmet needs from Wycombe, Chiltern and South Bucks districts. This housing growth is concentrated in sustainable locations with the majority of homes focused in Aylesbury Garden Town, to the north, close to Milton Keynes and a smaller proportion in Buckingham, Winslow, Wendover and Haddenham (strategic settlements).

# 1. Purpose of the Design SPD

## The opportunity



1.3.5 This is supported by growth at other larger and medium sized villages and with Neighbourhood Plans identifying housing growth in smaller settlements.

1.3.6 Significant employment growth is also planned with over 100 hectares of employment land identified predominantly around Aylesbury but also close to Milton Keynes in north east Aylesbury Vale. The area benefits from three sites with Enterprise Zone status at Silverstone Park, Westcott and Woodlands each focusing on different high growth sectors.

1.3.7 These new homes and jobs provide opportunities for the area, helping to sustain its towns and villages and improve their economic performance, but also present challenges.

1.3.8 The area contains many environmental designations which influence where development may take place and it is important that change does not erode the essentially rural character of the area, its rich heritage and the historic and distinctive character of its towns and rural settlements.

1.3.9 An important focus of the Design SPD is that new development responds to local character and distinctiveness. Whilst some development proposed is likely to be close to the edge of Aylesbury Vale (for example close to Milton Keynes) and may involve joint work with neighbouring authorities in its planning, the need to respond to the local character of Aylesbury Vale remains an important requirement.

1.3.10 There are also a number of strategic infrastructure proposals that could both impact on the character of parts of the area but also improve accessibility. These are:

- **High Speed 2 (HS2)** which will, extend north-south through the area and provide a rapid rail connection from London to Birmingham; and
- **East West Rail (EWR)** which seeks to re-establish the former Varsity line east-west across the area and will include a new station at Winslow and a spur route connecting to Aylesbury. Phase 1 is open from Oxford to Bicester with the second section to Bedford planned for completion in 2024 and options for a further extension to Cambridge and beyond coming forward.

# 1. Purpose of the Design SPD



## Good design



Examples of more innovative design delivered in the Aylesbury Vale in recent years, FROM LEFT: Gorrell Lane, Dadford (facade detailing / use of materials); Chandos Yard, Long Crendon (response to context); housing at Summer Hill, Buckingham (landscape and public realm); Drakes Place, Aylesbury (contemporary housing); and Marsworth Yard (response to wharfside character).

## 1.4 The value of good design

1.4.1 The importance of design quality is intrinsic to national planning policy with a clear mandate within the National Planning Policy Framework (NPPF) to deliver high quality built environments.

1.4.2 Good design can help transform places and enhance people's lives. The orientation and height of buildings; the materiality, enclosure and sunlight within a public space and the presence or absence of trees and planting in a street or space can have a profound impact on people's wellbeing and mental health. Good design and introduction of green infrastructure in particular can also improve the environment, reducing the carbon footprint, air pollution and overheating in summer, and improving water quality and management.

1.4.3 Research by the Commission for Architecture and the Built Environment (CABE) and the Royal Institute of British Architects (RIBA) and national guidance, including the Urban Design Compendium, have all demonstrated the link between good design and improved quality of life, equality of opportunity and economic growth.

1.4.4 As an example:

- A well designed hospital will help patients get better more quickly;
- A well designed school will improve the educational achievement of its pupils;
- A well designed park will improve health and well being;
- A well designed public realm increases retail rents;
- A well designed department store will have a direct impact on stock turnover; and
- A well designed neighbourhood will benefit from lower crime and increased value.

1.4.5 Good design is about more than just the architecture and in Aylesbury Vale we are looking to create high quality places that meet the needs of the whole community with streets and spaces that are accessible for everyone, that function well and improve the quality of life.

1.4.6 Good design from the outset, in accordance with the principles contained within this Design SPD, is likely to smooth the planning process. Pre-application discussions and Planning Performance Agreements can also assist this process.

1.4.7 The council celebrates projects which make an outstanding contribution to the design quality of the built environment in the area through annual design awards. These awards have been running for over 25 years and showcase good design of both small and larger developments including new build, building conversion and building refurbishment.



# 1. Purpose of the Design SPD

## 1.5 High quality design and innovation

1.5.1 The aim of this SPD is to inspire designers to rise to the challenge of delivering high quality, well designed buildings, streets and spaces that are in keeping with their environment and respond to the challenge of delivering sustainable development.

1.5.2 Designers are encouraged to be inventive and innovative; to prepare proposals that respond to place, that meet the needs of modern lifestyles and that are adaptable in the future. Contemporary solutions of high architectural quality that deliver outstanding places are welcomed and encouraged where they respond to and maintain or enhance their context.

1.5.3 This Design SPD is intended to be a design manual and a working tool. It is intended for frequent reference and will be essential for anyone charged with preparing or assessing the quality of planning applications.

1.5.4 Compliance with the Design SPD will help to speed up the planning process by reducing the chance of objections due to poor design.

1.5.5 This draft document was subject to a formal consultation with statutory consultees, developers and the local community between September and November 2022. The feedback received has been reviewed and where appropriate changes have been made to the Design SPD.

1.5.6 The Design SPD will be adopted by the council and as such will be a material consideration in determining planning applications submitted to the council. Having been subject to scrutiny and amendment through a public consultation process, the SPD will carry weight in decision making.

### Additional useful and interesting resources:

- Paved with gold: The real value of good street design (CABE, 2007)
- By Design, Urban design in the planning system: Towards better practice (DETR and CABE, 2000)
- The value of good design (CABE, 2002)
- The value of urban design (CABE and DETR, 2001)
- Valuing Sustainable Urbanism (Prince's Foundation, Savills and English Partnerships, 2007)
- Public Health England briefing for local authorities - Working together to promote active travel (2016)

## Good design



Aylesbury Waterside Theatre



# 2

## Design process

Design is an iterative process and preparing a scheme that responds to place must often balance many competing needs and interests. Delivering high quality design requires good designers and it also requires an understanding of the place within which a site is located, the sensitivities of the site and its surroundings and the opportunities and challenges that these present.

Knowing who to engage with, and at what stage through the development of the design, is important and can help to ensure that a proposal meets with the council's requirements.

This chapter sets out a robust process that applicants are expected to follow in preparing their proposals.



## 2. Design process

### 2.1 The design process

2.1.1 In order to deliver good design there are a number of important steps that must be taken. These steps are indicated in the simple flowchart in Figure 2.1.

2.1.2 The level of detail, and engagement required, will be dependent on the scale and complexity of the application.

#### Engaging professionals

2.1.3 This Design SPD alone cannot produce good creative solutions; this is the job of a creative professional. One of the first stages in preparing a design scheme will be to engage skilled design professionals to ensure high-quality solutions through the design process.

2.1.4 The council strongly encourages householders, local builders, developers and any other organisation commissioning design to employ appropriate design professionals such as architects, landscape architects, ecologists, arboricultural consultants, heritage consultants and urban designers.

2.1.5 There are a number of organisations which can assist including:

- Landscape Institute  
<https://www.landscapeinstitute.org>
- Royal Institute of British Architects  
<https://www.architecture.com>
- Royal Town Planning Institute  
<https://www.rtpi.org.uk>
- Urban Design Group  
<https://www.udg.org.uk>
- Chartered Institute of Ecology and Environmental Management  
<https://cieem.net/>
- Arboricultural Association  
<https://www.trees.org.uk/>
- Institute of Historic Building Conservation  
<https://www.ihbc.org.uk/>
- Chartered Institute of Highways and Transportation  
<https://www.ciht.org.uk/>

## Design process

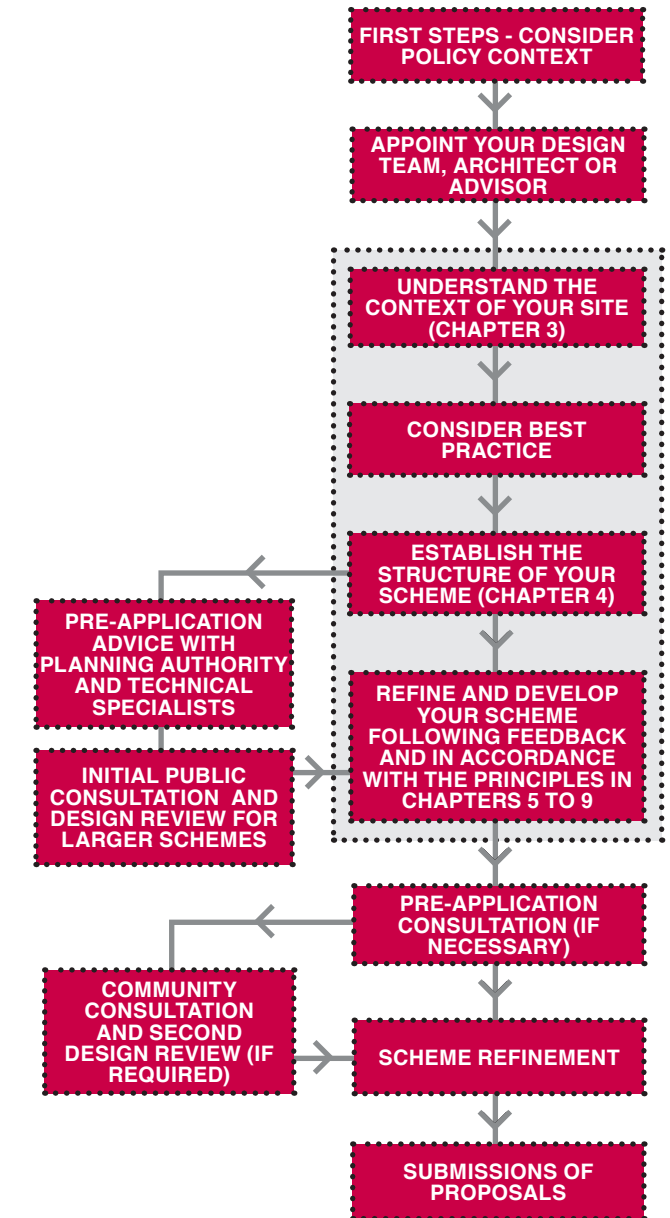

Figure 2.1: Flow chart setting out the design process for preparing a design proposal with reference to the relevant chapters in this Design SPD

## 2. Design process

## Design process

### Understanding the planning context

2.1.6 National and local planning policies will influence whether a site is suitable for development and the form and nature of this development. One of the first things that an applicant should do is to carry out research to understand relevant planning policy that relates to their site.

2.1.7 The Development Plan for the area is the Vale of Aylesbury Local Plan 2013 – 2033 together with a number of Neighbourhood Plans, which cover a significant part of the area.

2.1.8 The Local Plan can be found on the council website.

2.1.9 The Neighbourhood Plans can be found on the council website.

2.1.10 Aylesbury Garden Town (AGT) is the focus for much of the area's growth. The Vision for the Garden Town is set out in Policy D1 of the VALP and in the AGT masterplan. Further detail about the Garden Town is provided in Section 3.6.

2.1.11 There are also other supporting policy or strategy documents that may relate to a site. These may include Supplementary Planning Documents, Conservation Area Appraisals, Historic Character Area Assessments and Masterplans, which have been adopted or endorsed by the council.

2.1.12 Information on heritage, trees, ecology and conservation can be found on the council website.

2.1.13 Details of other planning documents endorsed or adopted by the council are available on the council website.

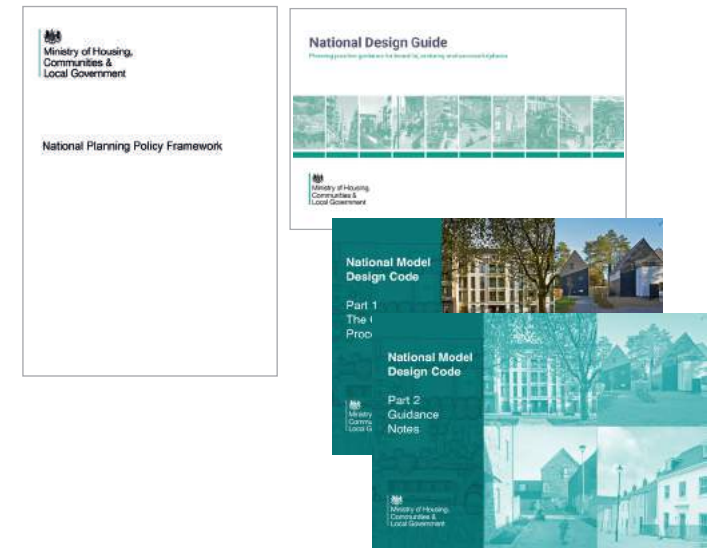

Figure 2.2: National policy guidance documents: the National Planning Policy Framework (NPPF), National Design Guide and National Model Design Code (Part 1 and 2)

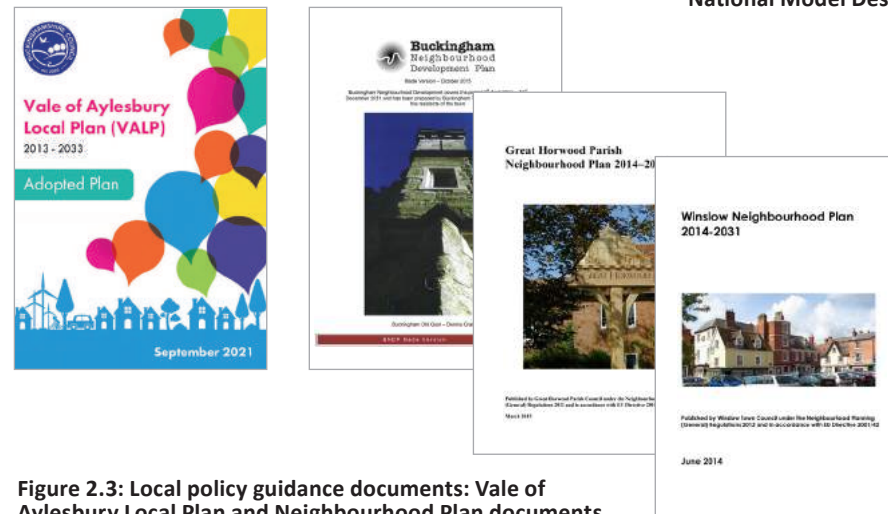

Figure 2.3: Local policy guidance documents: Vale of Aylesbury Local Plan and Neighbourhood Plan documents

### 2.2 Who to talk to

#### Early engagement

2.2.1 Depending on the scale of development, applicants should consult with relevant statutory and non-statutory authorities and council officers to understand their policy requirements and initial advice. Some of the more important relevant organisations are listed in Figure 2.4. This list should not be seen as being comprehensive.

#### Pre-application consultation

2.2.2 Applicants should hold pre-application discussions at an early stage in the design process. This will provide an important opportunity to identify and discuss emerging ideas and sensitivities and to ensure that the design process is heading in the right direction.

2.2.3 Pre-application discussions also provide an opportunity to discuss the information and level of detail required to accompany a particular planning application and an opportunity to get specialist technical advice for instance on heritage matters.

2.2.4 Planning Performance Agreements (PPAs) are recommended for larger applications. Information is provided at the on the council website.

2.2.5 Pre-application advice may be subject to charges. Details of fees and charges can be found on the council website.

#### Community consultation

2.2.6 Depending on the scale and nature of an application it may be appropriate to carry out consultation with the public and stakeholders. Applicants should refer to the Buckinghamshire Council's Statement of Community Involvement which sets out a Code of Practice for consultation. This can be found on the council website.

2.2.7 Community engagement can be a useful way to discover more about a site and its setting and to gain an understanding of any concerns that the community may have in relation to an application.

2.2.8 Applicants should document the engagement process and demonstrate how community and stakeholder feedback has been taken account of in their proposals.

2.2.9 The council encourages all applicants and their agents to consult their neighbours before they submit a planning application.

#### Refining proposals

2.2.10 Applicants should refine their proposals in light of pre-application discussions and community consultation responses. It is the job of the applicant and the design team to review the design and to try to satisfy concerns.

2.2.11 Applicants will be expected to outline all consultation responses and how these have been considered.

#### Relevant Statutory Authorities and organisations

- Natural England: Landscape, Green Infrastructure and Biodiversity;
- Chilterns Area of Outstanding Natural Beauty;
- Historic England: heritage assets;
- Canal and River Trust;
- Environment Agency: flooding, rivers and water pollution although Buckinghamshire Council are the Lead Local Flood Authority;
- Highways Authority;
- Utility companies;
- Police service: police liaison and crime prevention officer;
- Fire service; and
- Town and parish councils.

Figure 2.4: Organisations that might be relevant to consult to for pre-application advice

## 2. Design process

### Submission of proposals

2.2.12 The level of information that the council will require the applicant to submit as part of a planning application will depend on the scale and nature of the proposal.

2.2.13 Where proposals affect a listed building, listed building consent is required for all works of demolition, alteration or extension that affect its character as a building of special architectural or historic interest. Check with the Council to confirm whether listed building consent is required. Refer to Chapter 4, DES17 for further details.

2.2.14 Reference should be made to the Local Validation List to understand the documents that will need to be submitted. This can be found on the council website.

### Design Review

2.2.15 The NPPF advocates the use of design review to improve the quality of development (NPPF July 2021, paragraph 133). The council will either utilise an existing panel (e.g. BOBMK) or establish a new design review panel or other review process, to provide independent and professional design advice and evaluation of significant schemes, either by virtue of their scale or sensitivity, that are proposed in the area. Consideration is being given to establishing a pilot Design Task Force to raise the quality of design in the Aylesbury Garden Town.

2.2.16 Design review can be a highly effective process which provides constructive criticism and challenge to project designs by peer review. It is applicable to a wide range of design projects including masterplans, buildings, landscapes, streets and spaces. Applicants should discuss the requirement for design review with the council as part of their pre-application discussions. Applicants will be expected to pay for the design review service.

2.2.17 Schemes should be presented to the panel early in the design process when the panel's inputs can be most helpful and influential and again later in the design process when the scheme is more fully developed closer to the submission of a planning application. The council will have regard to the recommendations from the design review panel when assessing applications.

## Who to talk to







# 3

## Understanding the context

Aylesbury Vale is an historic and beautiful area, with large tracts of its landscape and townscape protected for their special qualities.

One of the fundamental objectives of this Design SPD is to ensure that new development respects, responds to and enhances the unique characteristics of the area. Development should share common characteristics with its locality, integrate and function as a natural part, or extension of existing settlements and contribute in a positive manner to the character of Aylesbury Vale.

An understanding of context is an essential starting point and this chapter identifies the approach that applicants should take to achieve this.



# 3. Understanding the context



Winslow - the market square



Wendover - historic properties

## 3.1 Introduction

3.1.1 This chapter provides an overview of Aylesbury Vale, outlining much of what makes it distinctive and special.

3.1.2 It identifies many of the important characteristics that an applicant will be expected to consider to:

- Understand the context and character of their site; and
- Establish the constraints and opportunities that will guide their proposals.

3.1.3 Applicants will be required to demonstrate a clear link between their appraisal of the context, any applicable planning designations, the character of their site, physical constraints and opportunities and their development proposals. This link or rationale will need to be articulated through the Design and Access Statement and any other document that will support their planning application.

3.1.4 Applicants will be expected to make use of a range of tools to support their analysis including figure ground studies, space syntax analysis, historic maps and local precedent studies detailing typologies and materials.

3.1.5 The Design and Access statement will include a character study and a site appraisal and this chapter sets out the basis for the information required to produce them.

3.1.6 The steps required in this process to understand the context of a site are set out in the flow chart in Figure 3.1.

3.1.7 A checklist is provided at the end of the section providing prompts to applicants on the issues that may be relevant and that require consideration in understanding their site and the context within which it is located.

# Introduction

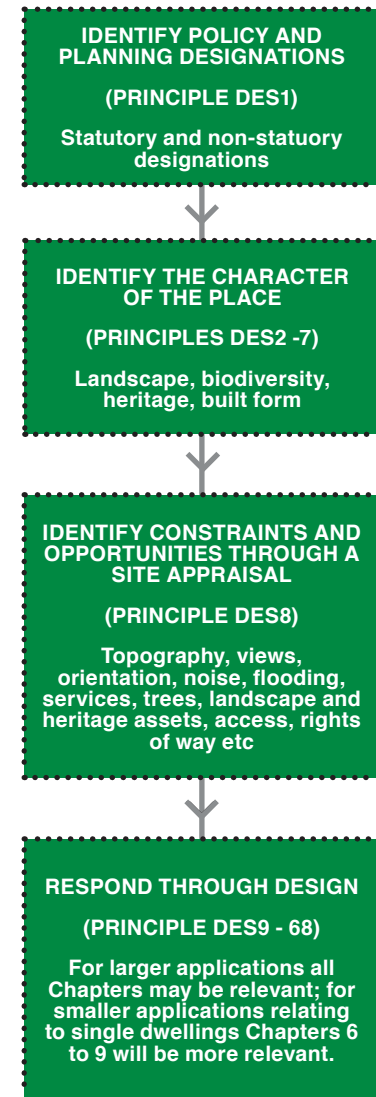

Figure 3.1: Flowchart indicating the process applicants should follow to 'Understand the context' of their site

# 3. Understanding the context

## Overview of the area

### 3.2 Overview of the area

3.2.1 Aylesbury Vale covers an area of approximately 90,000 hectares and is a largely agricultural area extending from the Chiltern Hills and Wycombe in the south towards Milton Keynes and Northamptonshire to the north. Oxfordshire is to the west and Hertfordshire and Bedfordshire to the east.

3.2.2 Aylesbury Vale is characterised by low-lying vales and clay plateaus, interrupted by distinctive low hills and ridges. The chalk scarp of the Chilterns AONB to the south-eastern boundary of the area provides a prominent backdrop to views in much of the southern part of the Vale.

3.2.3 The underlying geology informs both the landscape and the rich and varied vernacular architecture of the area's many villages and towns.

3.2.4 The Vale's main settlements, Buckingham, Winslow, Aylesbury and Wendover are located along the A413 which runs north-south through the area, with Haddenham to the west on the A418 that connects Aylesbury with Oxford. Other important routes include the A418 and A41 which meet at Aylesbury and the A421 which extends east west across the northern part of the Vale. Beyond these routes the area is characterised by a network of smaller roads and lanes with larger arterial routes, the M40 and M1 skirting the edge of the area to the east and west.

3.2.5 The West Coast mainline crosses the eastern edge of Aylesbury Vale and regional trains serve stations towards the south of the area.

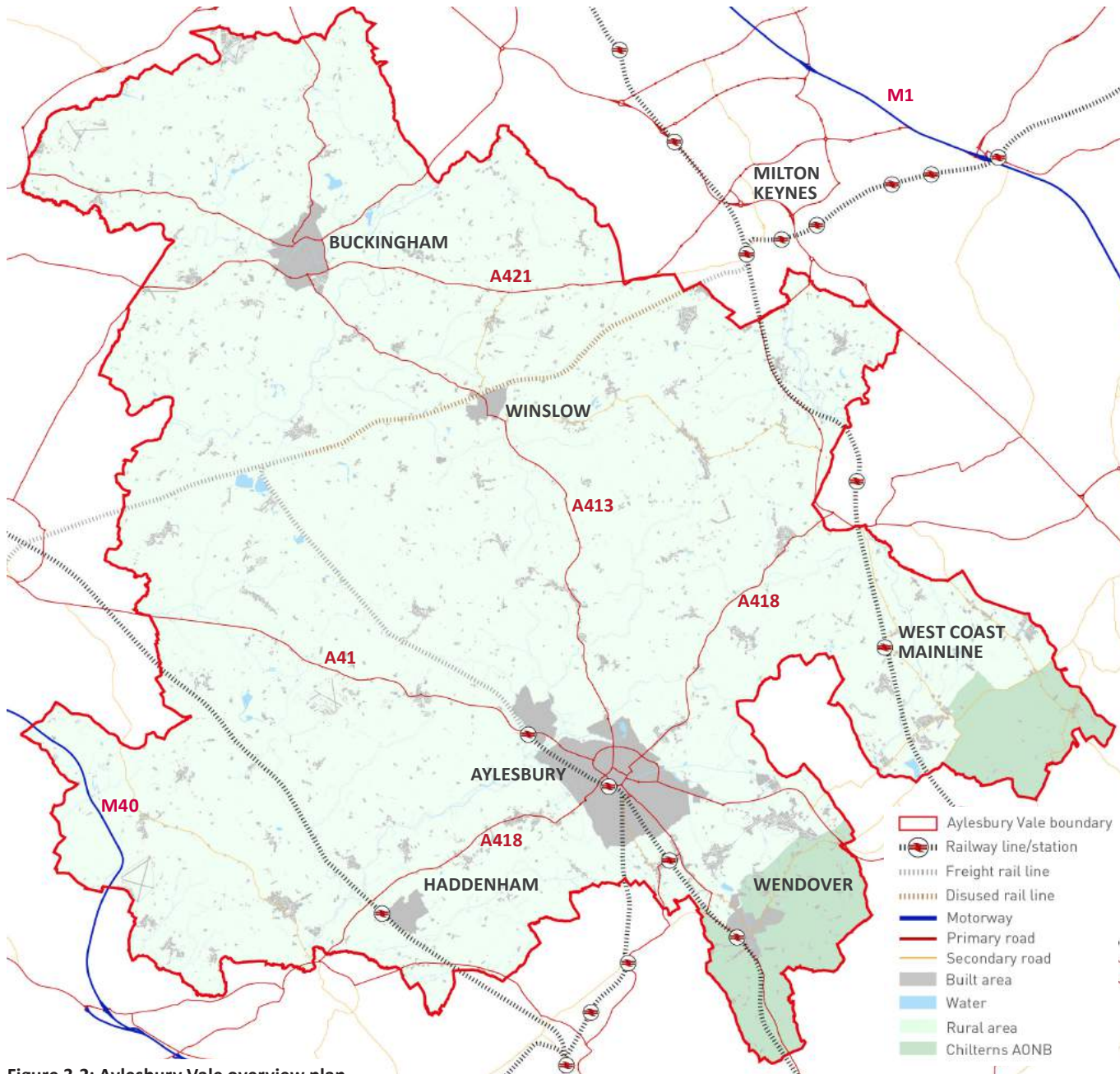

Figure 3.2: Aylesbury Vale overview plan

## 3. Understanding the context

3.2.6 Aylesbury, located towards the south of the area, is the main settlement and the historic market town provides a focus for shopping and employment. It has a growing cultural scene and was the birthplace for the paralympic movement. The town is home to the national centre for disability sports and to the University Campus Aylesbury Vale (UCAV).

3.2.7 The area's environment is protected by a number of local, national and international designations which seek to preserve the area's natural and historic environment for future generations.

3.2.8 Aylesbury Vale also has many sites valued for their biodiversity including a Special Area of Conservation (SAC) at Chiltern Beechwoods, 28 Sites of Special Scientific Interest, over 200 Local Wildlife Sites, Local Nature Reserves and Biodiversity Opportunity Areas. The area has approximately 3,000 listed buildings, over 60 scheduled monuments, over 80 conservation areas and 13 registered historic parks and gardens. There are also numerous non-designated heritage assets within the area.

3.2.9 Applicants will need to carry out their own desktop analysis to understand whether their site is covered by any designations.

3.2.10 Applicants should check the National Heritage List for England (NHLE) for nationally designated heritage assets, and AVDC Guidance on heritage, trees and conservation for advice about listed buildings, conservation areas and non-designated heritage assets.

3.2.11 Applicants can find information on AVDC's tree management strategy, and the protection of trees and hedgerows on the council website.

3.2.12 The Buckinghamshire Historic Environment Record (HER) is a rich source of information on the area's landscapes, places, buildings, monuments and archaeology. Their records can be searched using the online map and database at Buckinghamshire's Heritage Portal.

3.2.13 The area has a significant number of Neighbourhood Plans and applicants should refer to these for detailed local information in their context analysis as well as to determine the local policies. Some provide relevant information on the designations, assets and/ or settlement character of the area and some also set detailed design policies.

3.2.14 Designations and features that help to characterise Aylesbury Vale are identified in Figures 3.3 to 3.10 on the following pages.

## Overview of the area

VALP Policy references: BE1; NE1; NE3

### Principle DES1: Designations

Applicants should clearly identify whether their site lies within or in the setting of any statutory or non-statutory designation. Any development proposals within or in the setting of one or more of these designations will be required to demonstrate how the proposals respond to national and local policies relevant to that particular designation.

# 3. Understanding the context

## Overview of the area

VALP Policy references: NE3; NE4

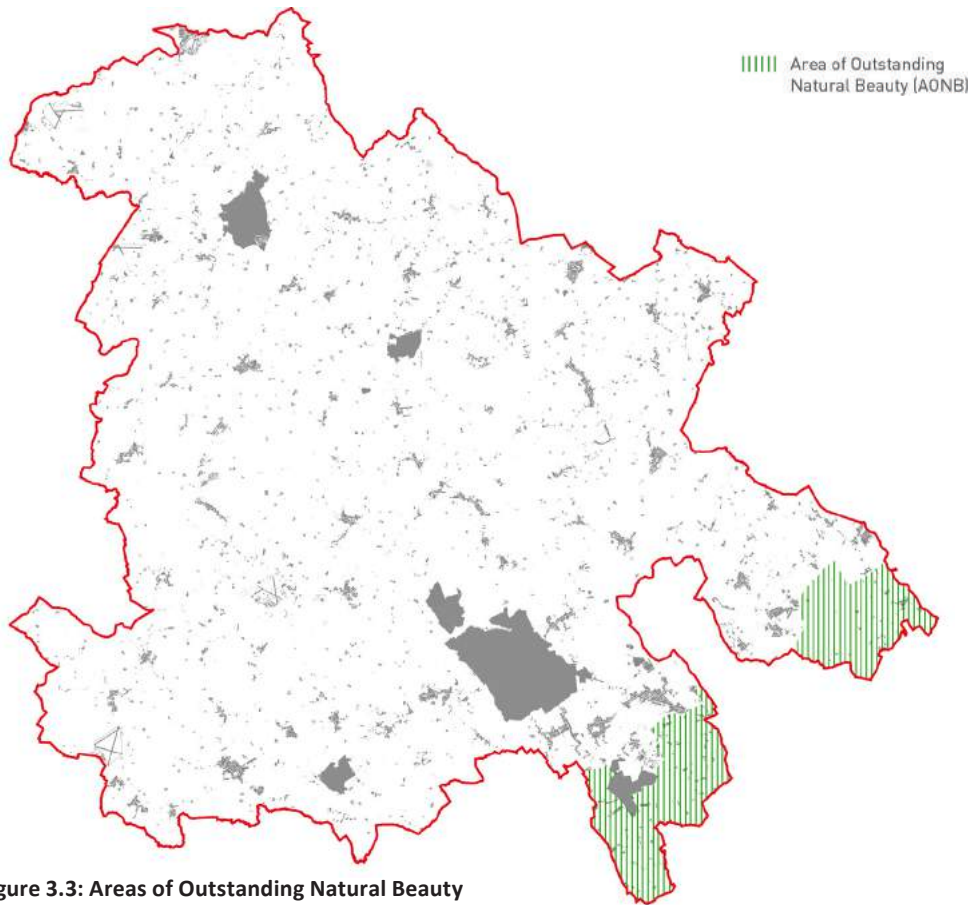

Figure 3.3: Areas of Outstanding Natural Beauty

### Chilterns AONB

**Area:** 4,665Ha (5.2% of Aylesbury Vale)

**Character:** Elevated land, sometimes wooded, with a steep chalk escarpment that offers panoramic views northwards across the area.

**Importance:** Any development within the AONB must conserve and enhance its distinctive features. Land outside of the AONB contributes to its setting and development should not adversely affect views in and out of the AONB.

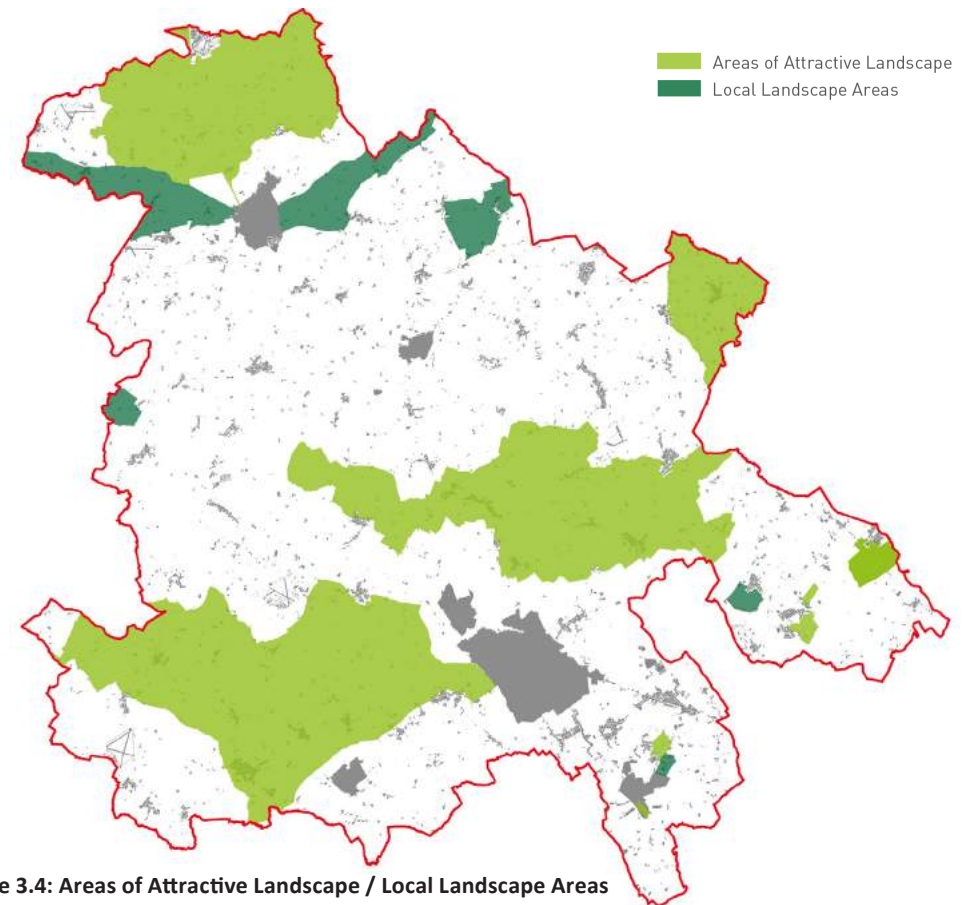

Figure 3.4: Areas of Attractive Landscape / Local Landscape Areas

### Areas of Attractive Landscape / Local Landscape Areas

**Area:** 27,768Ha (30.8% of Aylesbury Vale)

**Character:** varies dependent on location within the area

**Importance:** Local landscape designations. Areas of Attractive Landscapes (AAL) have 'County wide' landscape value and are designated for their 'scenic beauty, nature conservation interest and amenity value'. Local Landscape Areas (LLA's) have area wide value and are designated for their special contribution to the appearance and the character of the landscape within Aylesbury Vale

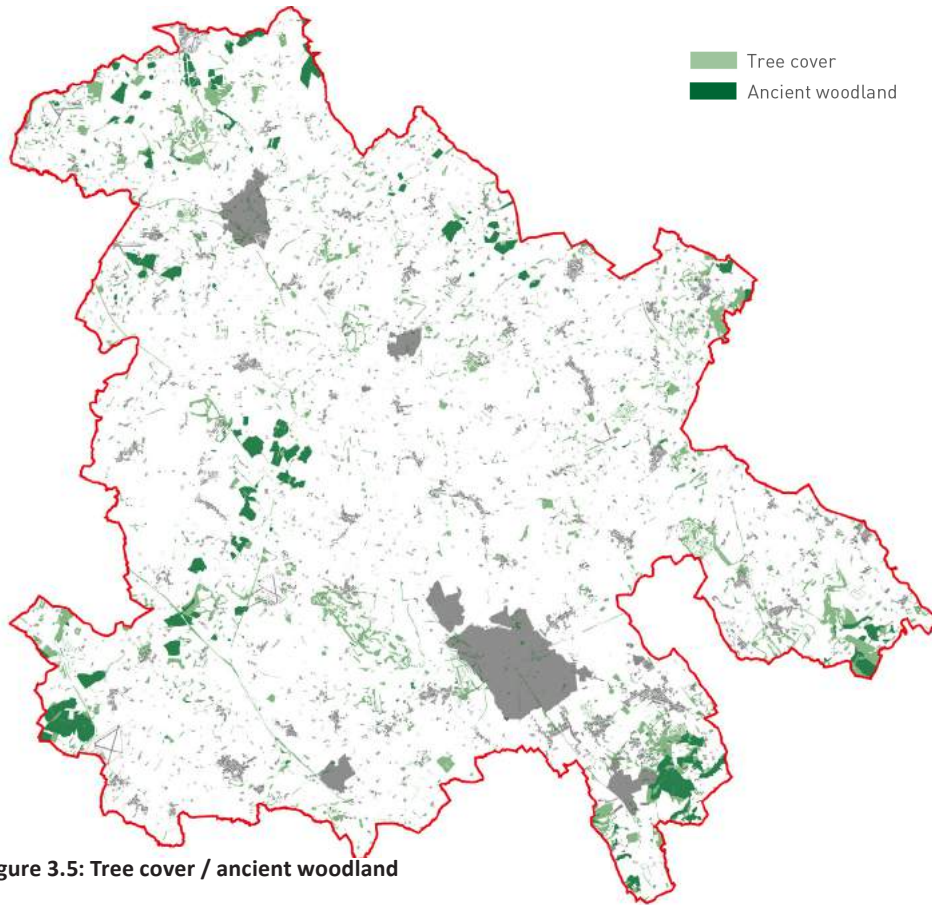

Figure 3.5: Tree cover / ancient woodland

### Tree cover / ancient woodland

Area: 7,407 / 2,184Ha (8.2 / 2.4% of Aylesbury Vale)

**Character:** Broadleaved and ancient woodland is concentrated in the south within the Chilterns AONB, north of Buckingham within Whittlewood Forest and in the west of the area throughout Waddon Chase. Priority wood pasture and parkland is most notably at Stowe Park in the north. Traditional orchard is found in small, fragmented parcels particularly to the east.

**Importance:** Woodlands provide vital habitat and support for wildlife as well as resilience to, and buffering of climate change. Woodlands often play a role in softening and enhancing settlement and built form, and can provide a sense of seclusion and tranquility.

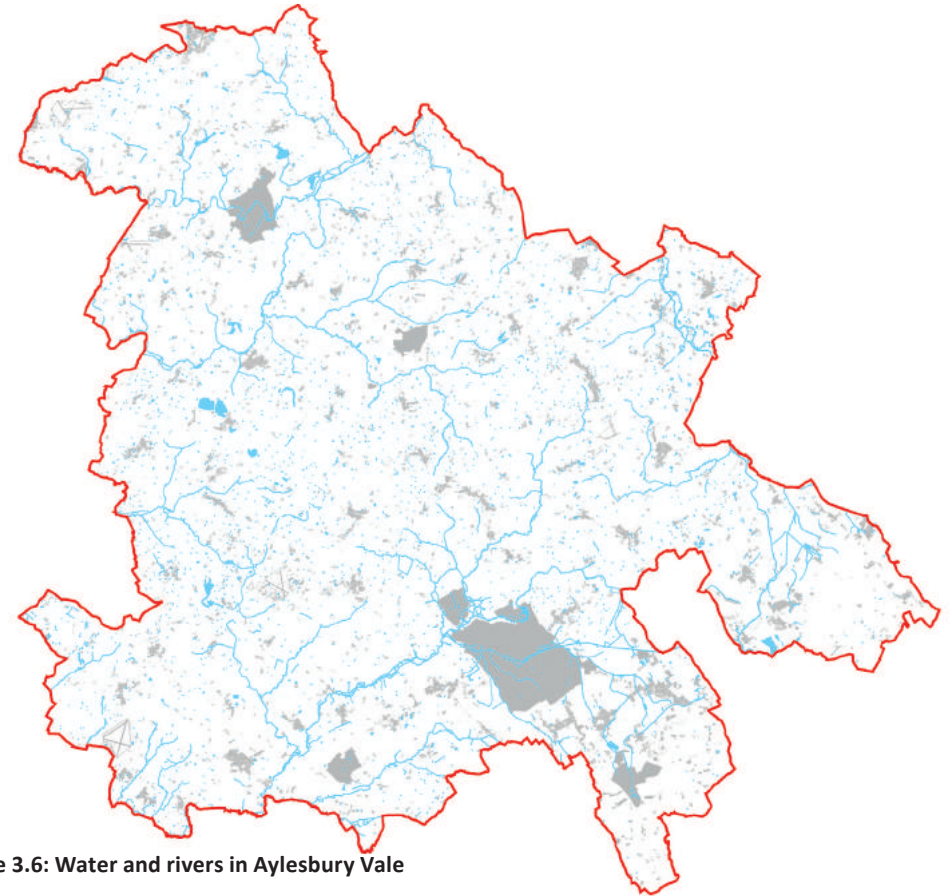

Figure 3.6: Water and rivers in Aylesbury Vale

### Water and rivers

Area: 770Ha (0.9% of Aylesbury Vale)

**Character:** The extensive network of watercourses running from the area's higher ground to its valleys are an important feature of the landscape. The main watercourses in the area are the River Thames (a tributary of the River Thames and the River Great Ouse). The Grand Union Canal passes through Aylesbury Vale with a spur terminating in Aylesbury town centre. The Wendover Arm is currently undergoing restoration.

**Importance:** The area's watercourses enhance character and biodiversity and should be retained, protected and enhanced within development.

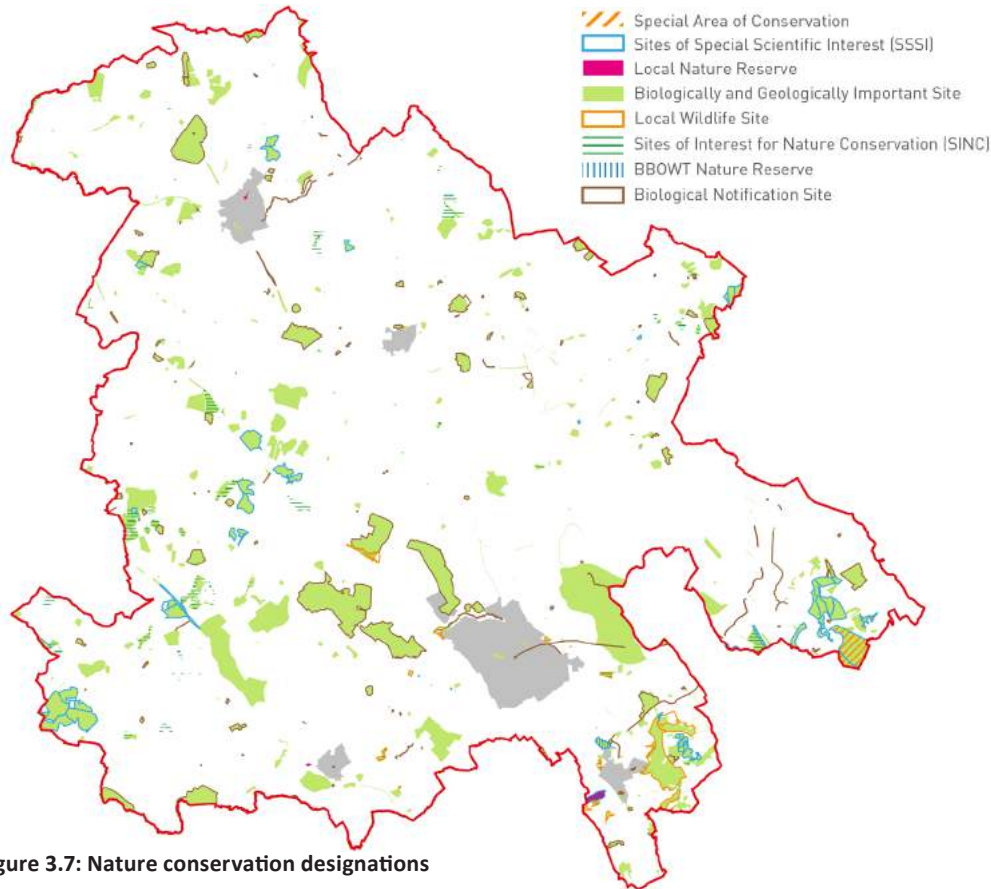

Figure 3.7: Nature conservation designations

### Nature conservation / biodiversity

**Area:** 8,767Ha (9.7% of Aylesbury Vale)

**Character:** The designated site network is concentrated within the south east and western borders of the area, taking in priority habitats of deciduous woodland, lowland meadow and heathland.

**Importance:** International and national designations protect the best semi-natural wildlife habitats in the area and are home to many of the rarest, threatened and protected species. Local wildlife sites, country wildlife sites and BBOWT reserves support the higher designations, serving as stepping stones and connecting corridors for biodiversity, as habitat buffers, and to dilute the pressures on habitats such as those that arise from recreational use.

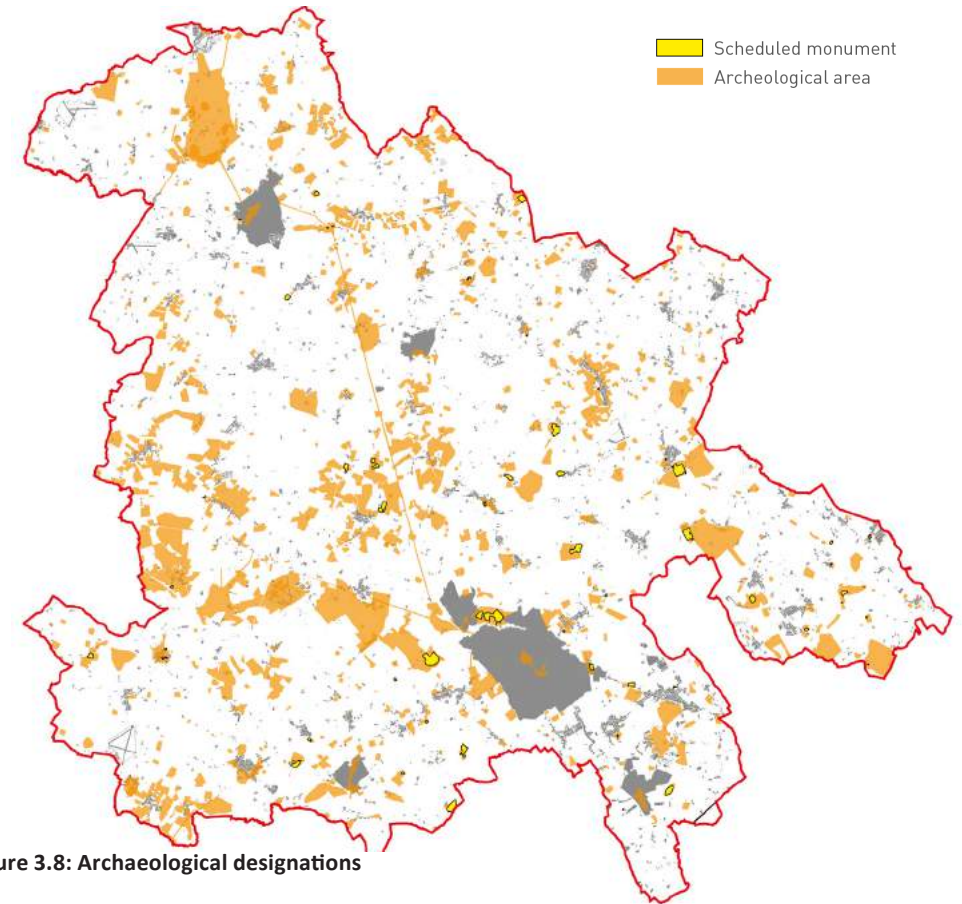

Figure 3.8: Archaeological designations

### Archaeology

**Area:** 12,556Ha ( 14.0% of Aylesbury Vale)

**Character:** Varies

**Importance:** Aylesbury Vale is rich in archaeology reflecting its history and includes 61 scheduled monuments. More information regarding scheduled monuments can be found in the Ancient Monuments and Archaeological Areas Act 1979 and on the Historic England website.

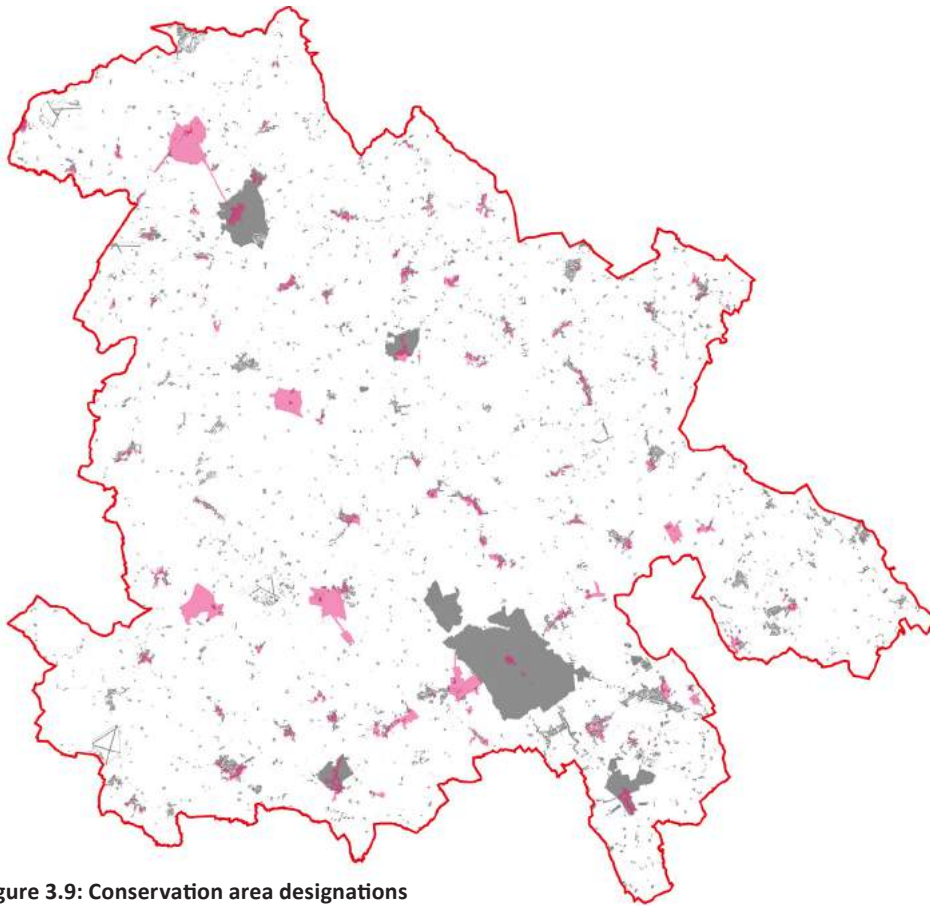

Figure 3.9: Conservation area designations

### Conservation areas and other heritage assets

**Area:** 2,227Ha (2.5% of Aylesbury Vale)

**Character:** Characteristics of each of the 83 conservation areas are described on the council’s website. Further guidance can be found in Conservation Area Character Appraisals and the Conservation Management Plan.

**Importance:** Designated for their special architectural or historic interest. The area also includes over 3,000 listed buildings (Refer to section 4.3 for detail on how to respond to listed buildings when preparing development proposals). and a local list of non-designated heritage assets.

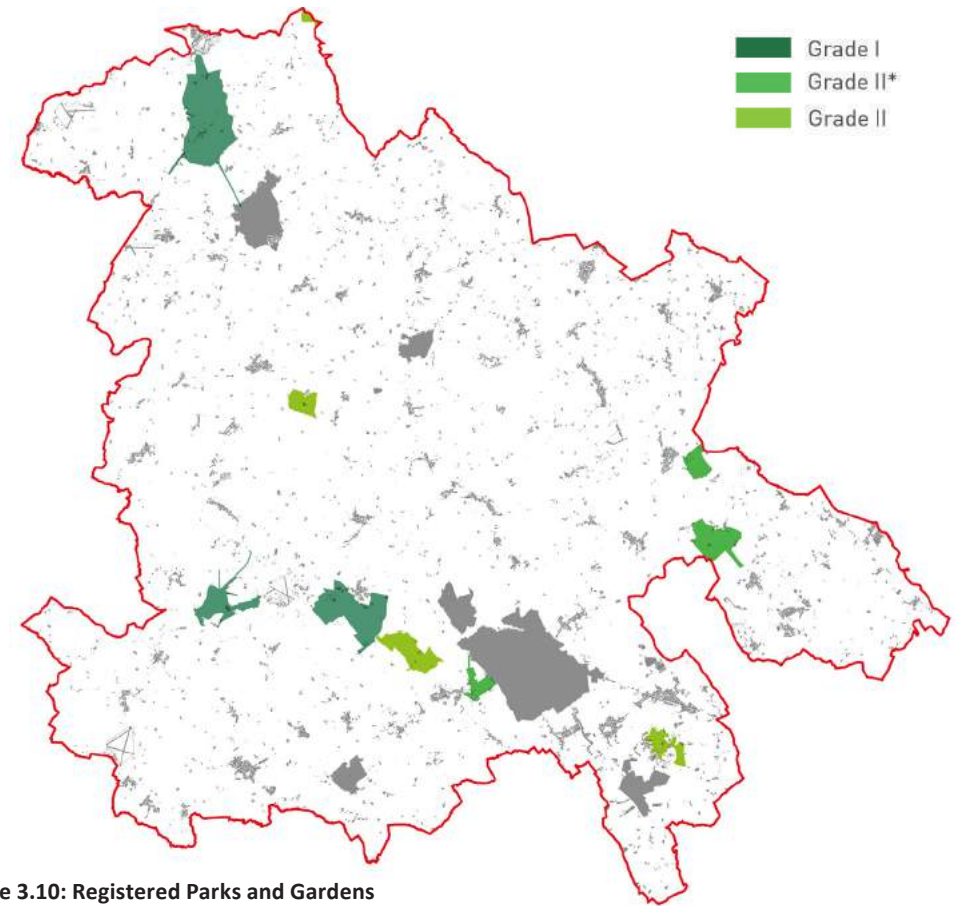

Figure 3.10: Registered Parks and Gardens

### Historic parks and gardens

**Area:** 2,534Ha (2.8% of Aylesbury Vale)

**Character:** Designed landscapes often associated with country houses (11 wholly within Aylesbury Vale including the Grade I Stowe, Waddesdon Manor and Wotton House)

**Importance:** The register of parks and gardens, established in 1983, identifies landscapes of national interest and their designation gives them equal policy status with listed buildings and scheduled monuments.



### 3. Understanding the context

### Overview of the area

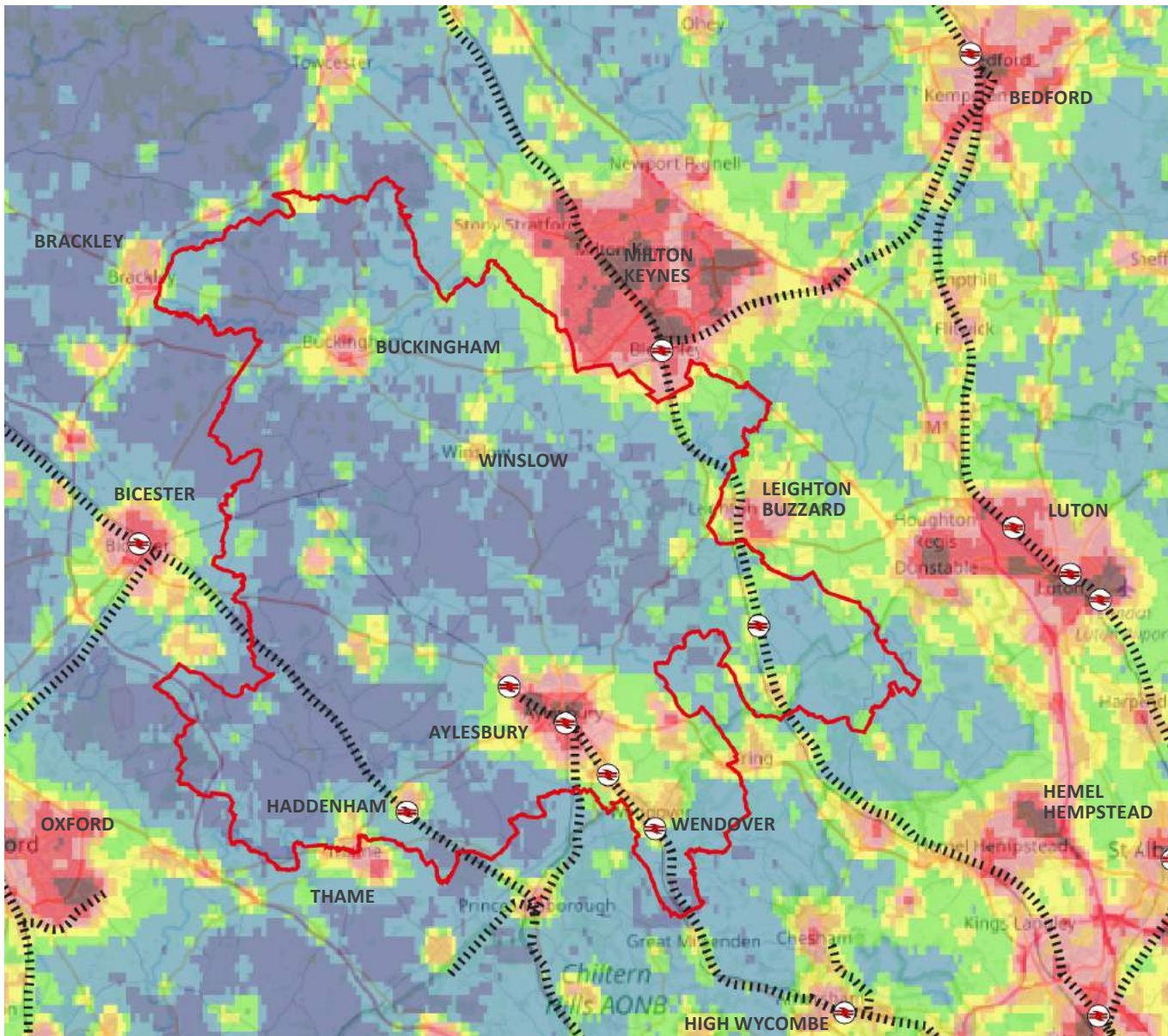

Figure 3.11: Aylesbury Vale dark skies / tranquility

3.2.15 Whilst Aylesbury Vale is close to Greater London and is bordered by Milton Keynes, Bicester and Oxford the heart of the area has dark skies allowing views of the Milky Way and creating a sense of rural tranquility. It is noteworthy that the area has darker skies than the Chilterns AONB to the south.

3.2.16 Dark skies can have value for nocturnal wildlife such as barn owls, bats and badgers, many of which are protected species.

# 3. Understanding the context

## Landscape character

VALP Policy references: NE4

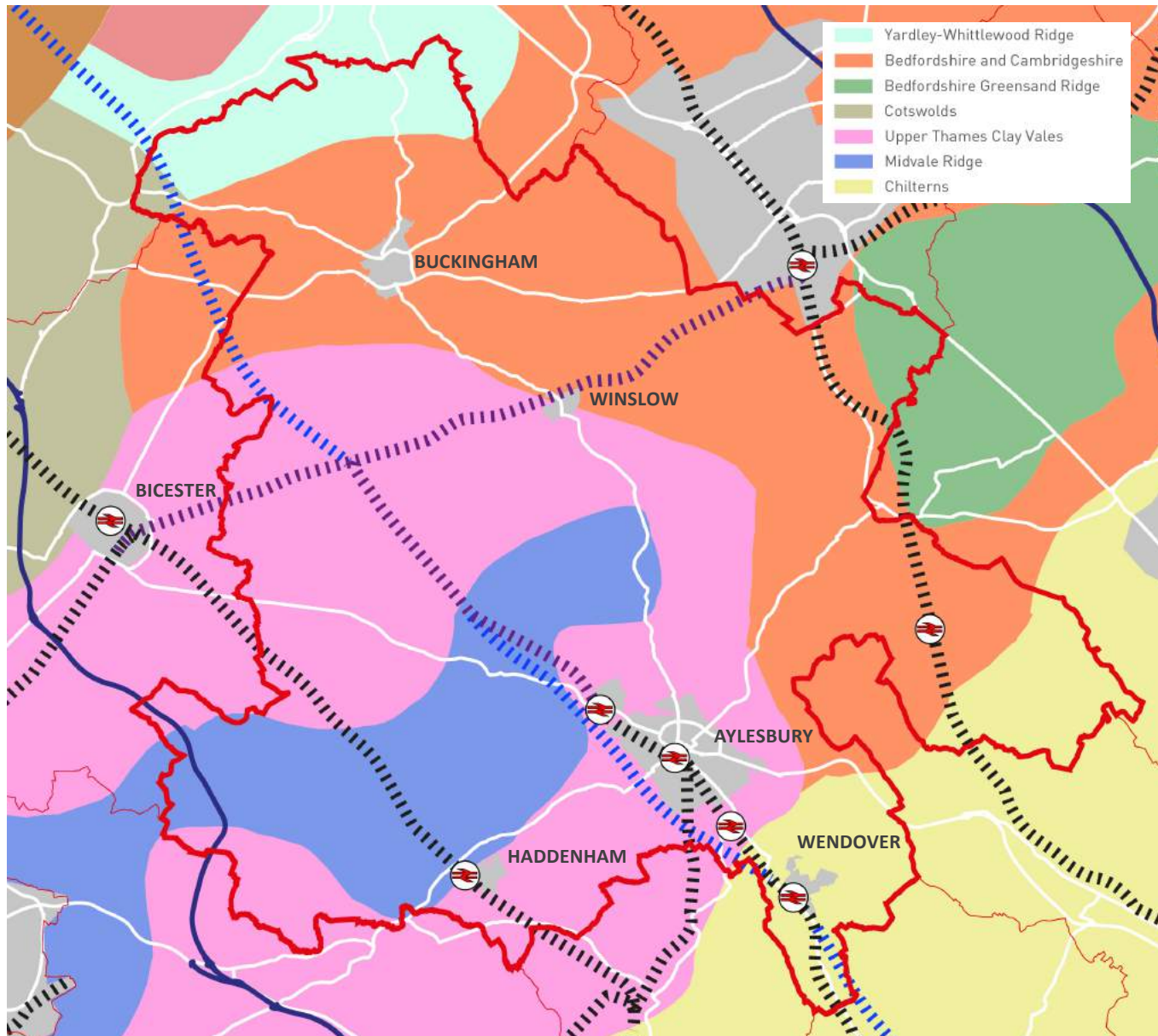

Figure 3.12: Aylesbury Vale National Character Areas

### 3.3 Landscape character

#### Principle DES2: Landscape character

Applicants should identify the Landscape Character Typology and Area in which their site is located. An understanding of the key characteristics of the landscape should guide and influence design development, including but not limited to identifying suitable site layout and connectivity, scale and massing, materials and detailing.

3.3.1 Aylesbury Vale has a varied and distinct landscape character influenced by the underlying geological formations, influencing soils and the overlying pattern of watercourses and vegetation. This shapes our built environment, from land use and settlement pattern, to the building materials used in historic construction.

3.3.2 The Vale has a predominantly rural character whilst accommodating the main settlements of Buckingham in the north, Winslow in the central part of the area, and Aylesbury, Haddenham and Wendover in the south. The area is characterised by its gently undulating clay plateau landform, which is dissected by ridges and low-lying hills.

3.3.3 The Vale contains six National Character Areas (NCAs) which reflects the diversity of this landscape. Within the south and the west of the area, the lowland topographic areas fall under the Upper Thames Clay Vales (NCA 108), whereas the north and east is characterised as Bedfordshire and Cambridgeshire Claylands (NCA 88).

## 3. Understanding the context

3.3.4 Both character areas typically have a gently undulating landscape shaped by watercourses. Large-scale, arable practices within a regular field pattern dominates the Bedfordshire and Cambridge Claylands. On the other hand, pastoral farming is more prevalent within the Upper Thames Clay Vales, due to the heavy clay soils. A mosaic of semi-natural habitats covers these character areas including wetlands, fen, reedbeds, wet woodland, ancient woodland and unimproved grassland.

3.3.5 The Chilterns (NCA 110) makes up the southern boundary of Aylesbury Vale, with its steep chalk escarpment creating an abrupt contrast to the surrounding low-lying vales. The Chilterns NCA is largely designated as an Area of Outstanding Natural Beauty (AONB), boasting dramatic and panoramic views to the surrounding countryside, making it a popular location for recreation.

3.3.6 Running parallel to the north of the Chilterns, the Midvale Ridge (NCA 109) and the Bedfordshire Greensand Ridge (NCA 90) form elevated ridges that contrast with the surrounding flat countryside.

3.3.7 The Midvale Ridge is a densely wooded limestone ridge which hosts both arable and pastoral farming practices, whereas the Bedfordshire Greensand Ridge sees a steep scarp which has been incised by rivers to create distinctive valleys with riparian habitats. Forming the northern boundary of the area, the Yardley Whittlewood Ridge (NCA 91) gives a further topographical contrast to the low claylands of the Vale. The gently undulating limestone ridge offers extensive views across the surrounding countryside and a rich variety of semi-natural habitats, whilst having a dominance of medium-scale, arable farming.

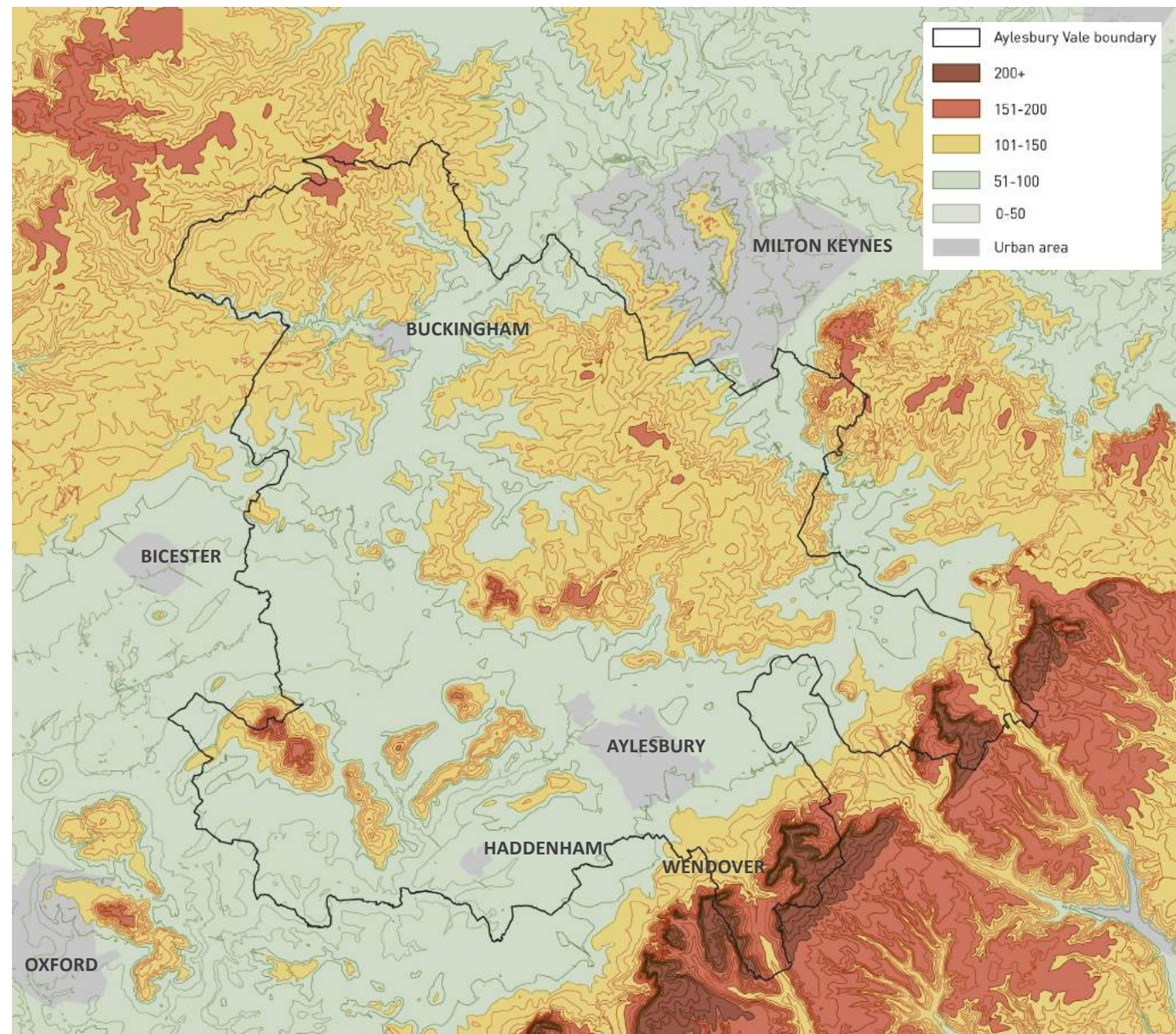

Figure 3.13: Aylesbury Vale topography

# 3. Understanding the context

## Landscape character

VALP Policy references: NE4

### Local Landscape Typologies and their characteristics

3.3.8 The local landscape character assessment divides the Vale into 13 Landscape Character Typologies (LCT) derived from the National Character Areas. These are summarised below together with a thumbnail image that identifies the location of each. Larger plans that indicate how each landscape character area relates to existing settlements are provided in Appendix B.

3.3.9 The assessment further characterises each LCT into 79 distinct Landscape Character Areas which provides more detail on the distinct landscape features and key characteristics. Refer to the council's website for full details. In the Chilterns AONB and/ or the locally designated Areas of Attractive and Local Landscape Areas, reference should be made to their Special Qualities.





Typology	Landform and views	Vegetation	Settlement and materials
 <p><b>LCT 01 Wooded Ridge</b></p>	A broad and gently undulating ridge which lacks dramatic landform, however incised valleys mark the plateau margins. Views are generally contained by woodland.	Coniferous and broad-leaved woodland give dense land coverage. Ancient woodland blocks and a strong hedgerow pattern with mature oak trees sit alongside this.	The dispersed settlement pattern and meandering lanes add to the tranquil character. Local vernacular and traditional building materials of limestone, timber and predominantly red brick.
 <p><b>LCT 02 Incised Valleys</b></p>	Small, steep and narrow valleys created from the incision of the Great Ouse. Landform limits views and visual detractors arise from main roads and arable farming.	Ecological interest is created from the base-rich ferruginous fens and scattered woodland. Oak and some ash dominate alongside ground flora typical to ancient woodland.	Historic settlement in traditional materials of limestone, timber and red brick, and field pattern, including isolated farmsteads, is focused along the Great Ouse river before dispersing up-slope as arable farming becomes the dominant land use.
 <p><b>LCT 03 Valley Bottom</b></p>	The wide floodplain straddling the Great Ouse is coupled with gently sloping topography. Views are generally constrained by landform, and pylons and roads act as visual detractors.	Great biological interest is found within bankside vegetation, wetland trees, shrubs, grasses, reeds and small woodland pockets. Distinctive willows overhang the meandering river.	Intimate and enclosed landscapes exist along the river, turning to large-scale arable farming further up the valley sides. The low density of typically red brick and timber settlement includes traditional weirs and mills.
 <p><b>LCT 04 Undulating Clay Plateau</b></p>	The rolling landform of the clay plateau is shaped by a series of shallow rides and valleys. Views within the LCT are contained by landform; however the plateau margins provide extensive vistas.	Many fen sites comprise a variety of herb and grass species. Woodland blocks in the north contain a large proportion of ancient woodland and clipped hedges are dominated by oak and ash trees.	Historic villages which are accessed by winding lanes. The landscape structure is enhanced by the vernacular buildings which use a variety of materials including timber, brick and thatch.

Figure 3.14: Aylesbury Vale landscape character typologies (part 1)

# 3. Understanding the context

## Landscape character

VALP Policy references: NE4





Typology	Landform and views	Vegetation	Settlement and materials
 <p><b>LCT 05 Shallow Valleys</b></p>	Shallow and poorly defined valleys incise the gently sloping or flat landscape, giving limited views over the LCT. Significant visual detractors come from the network of pylons and the railway.	Biodiversity interest predominantly comes from the river corridor. Pollarded willows and black poplars are important local tree species. Grassland cover dominates with strong hedgerow pattern. Woodland is sparse.	Overall lack of settlement, however some well-preserved, historic, nucleated villages are limited to marginally higher ground. Buildings often limestone, red brick or rendered. Limited road access is coupled with historic and industrial relics, resulting in a remote and tranquil area.
 <p><b>LCT 06 Greensand Ridge</b></p>	A distinct wooded scarp which has been eroded into an undulating landform, creating steep valleys and small promontories. Long distance views towards Milton Keynes and extensive views over the Ouzel valley.	Extensive woodland cover consists of ancient semi-natural woodland, secondary woodland and coniferous plantations. Heathland and acidic grassland habitats can also be found.	Narrow and winding lanes traverse up the scarp face. Building materials are typically red brick, with historic examples using mixed materials; red brick, timber, sandstone and render. Great Brickhill village occupies a section of the scarp, displaying strong local vernacular with thatched roofs, local sandstone in buildings and walls.
 <p><b>LCT 07 Wooded Rolling Lowlands</b></p>	An undulating clay landscape populated with small ridges and hills. Views to the Chilterns from the south of the LCT however a well wooded and treed landscape limits views The M40 corridor is a visual detractor.	The dominant grassland coverage is interspersed with large blocks of ancient woodland. A strong hedgerow pattern with mature oaks, whilst poorly drained soil is often scrub.	Low density, historic settlement and its associated enclosure is focused along ridgelines, creating a tranquil character, enhanced by meandering lanes and low-intensity farming. Building materials are typically red brick, with historic examples using mixed materials; thatched roofs, red brick, timber, sandstone and render.
 <p><b>LCT 08 Vale</b></p>	Poorly drained, low-lying and flat landscape with an eroded shallow limestone ridge creating isolated fragments of higher ground. Extensive views available from the fringes of the LCT.	Intricate network of watercourses, including River Thames, are distinctively lined with mature black poplar trees. Surrounding agricultural grassland with mosaic of wet, species-rich habitats.	Roads radiating from central Aylesbury cross the Vale landscape, creating linear settlement patterns. Areas to the north and east are sparsely populated, therefore retaining a sense of remoteness. Historic materials displayed are mixed, typically red brick, limestone, timber, witchert, limestone and/or render.
 <p><b>LCT 09 Low Hills and Ridges</b></p>	Narrow ridges and small, steep hills create a distinctive landscape. Dramatic views are a major feature of the type, over both surrounding lower ground and towards the Chilterns.	Grassland provides the dominant vegetative cover and largely intact hedgerows are populated with ash. The low density of woodland is interspersed with blocks of ancient woodland. Mature and veteran trees indicate designed estate parklands.	Settlement consisting of limestone villages is mostly limited to ridges or hill tops, via narrow, sometimes sunken lanes. Strong historic landscapes surrounding villages and estates of Waddesdon, Eythrope and Hartwell. Witchert walls can be found on occasional houses and garden walls.

Figure 3.15: Aylesbury Vale landscape character typologies (part 2)

# 3. Understanding the context

## Landscape character

VALP Policy references: NE4





	Typology	Landform and views	Vegetation	Settlement and materials
	<b>LCT 10 Chalk Foothills</b>	Rolling chalk hills providing a between the lowlands and the chalk escarpment of the Chilterns, with transport and communication corridors in the valley bottoms. Views are generally contained by topography.	Lower slopes of the foothills are dominated by large arable fields. As elevation increases so does the mixture of farming, and increased frequency of scattered broadleaved woodland.	Settlement varies from sparse to extensive, typically nucleated villages. Remnants of restored chalk quarries alongside areas of commercial, light industrial and residential redevelopment.
	<b>LCT 11 Chalk Escarpment</b>	Steeply sloped Chiltern scarp which has been eroded to create a network of dry valleys and promontories. Panoramic views are available across the Vale and fringes of Milton Keynes, reflecting its designation as an AONB.	Poorly drained soil with extensive beech, oak and birch woodlands transition to beech 'hangers' on steep slopes. Wych elm and ash are found on the steepest slopes, and hawthorn, juniper and hazel coppice provide increased biodiversity.	A sparsely populated type with chalk promontories being the focus of historic fortified development and earthworks. This is reflected in the number of Scheduled Monuments within the LCT.
	<b>LCT 12 Chalk Dip Slope</b>	A gentle dip slope providing a transition between the steep scarp to the north and the chalk plateau in the south. Excellent views can be had, making the LCT popular for recreation.	Biodiverse chalk downland and extensive and diverse ancient semi-natural woodland cover reflects traditional management through clearance and grazing. Former common land has now developed into secondary woodland.	Settlement within the dip slope is sparse, reflected in the narrow lanes and isolated typically red brick farmsteads. Use for recreation is evident through the prevalence of public access, car parks and long distance footpaths.
	<b>LCT 13 Chalk Valleys</b>	Steep-sided, dry chalk valley which incises the Chilterns scarp. Transport and electrical corridors connecting the Vale to London, as well as pylons, lie in the valley bottom. Panoramic views across the valley are available at local vantage points.	The valley floor is characterised by large open fields with well-maintained hedges or linear tree belts. Valley sides are characterised by small blocks of calcareous beech woodland 'hangers' and ancient woodland, with upper slopes enclosed by narrow woodland belts.	Concentrations of settlement generally occur as ribbon developments along main road corridors, the A413 or within the town of Wendover. Smaller settlements and farmsteads can be found on the valley sides with materials in historic buildings typically with mixed red brick and flint panels, mixed coloured bricks, and occasional hung tile panels.

Figure 3.16: Aylesbury Vale landscape character typologies (part 3)

# 3. Understanding the context

## 3.4 Ecology

### Principle DES3: Ecology

Applicants should identify the priority habitats and protected species affected by their proposed development and adhere to relevant legislation. The design of new development should protect, enhance, create and connect biodiversity to support coherent and resilient ecological networks.

3.4.1 Aylesbury’s network of designated nature conservation sites consists broadly of priority grasslands in the east and west, floodplain grazing marsh along river courses to the west and east, small areas of heathland along the south-east and north-east border, small fragments of lowland fens in the north-east, wood pasture and parkland throughout the district, very small and fragmented areas of traditional orchard scattered through the district and broadleaved woodland through the north, south and east.

3.4.2 The central swathe between Aylesbury and Buckingham has a paucity of priority habitats and designations, with more intensive areas of agriculture being prevalent.

3.4.3 The Chilterns Beechwoods Special Area of Conservation (SAC) is set within the Chilterns National Character Area. The Chilterns have the most extensive area of native beech woodland in England. The SAC takes in the Ashridge Commons and Woods Site of Special Scientific Interest (SSSI) on the Buckinghamshire / Hertfordshire southern border. The area comprises a mosaic of different habitats that supports a rich breeding bird community.

3.4.4 Many of Aylesbury Vale’s 28 Sites of Special Scientific Interest are concentrated in the south of the district and lie within the Chilterns AONB. Over 200 Local Wildlife Sites provide important habitat links and create permeability across the landscape.

3.4.5 Biodiversity Opportunity Areas (BOAs) identify where the greatest opportunities for habitat creation and restoration lie. Twenty-three regional BOAs have been identified in Buckinghamshire, nine of which lie within Aylesbury Vale. BOAs will play an important role in underpinning the future Buckinghamshire Local Nature Recovery Strategy.

Biodiversity Opportunity Area	Habitats of importance
Ashridge & Ivinghoe Beacon	Lowland calcareous grassland; woodland; arable field margins; and wood pasture and parkland.
Whittlewood Forest	Lowland meadows; lowland fen; woodland; wood pasture & parkland; eutrophic standing water; reedbed; ponds; and hedgerows.
Greensand Ridge	Lowland heathland; lowland acid grassland; lowland fen; hedgerows; lowland meadows; ponds; and wood pasture & parkland.
Whaddon Chase	Fens; hedgerows; lowland meadows; woodlands; wood-pasture & parkland; and ponds.
Bernwood	Woodland; wood pasture & parkland; lowland meadows; ponds; and hedgerows.
Upper Ray	Lowland Meadow; ponds; rivers; hedgerows; and lowland mixed deciduous woodland.
Brill and Muswell Hill	Woodland; and lowland calcareous grassland; and lowland dry acid grassland; ponds; and hedgerows.
Thames Valley	Rivers and streams; lowland meadows; hedgerows; ponds; and wood pasture & parkland.
Wendover Woods	Hedgerows.

Figure 3.17: Table indicating biodiversity opportunity areas in Aylesbury Vale

# 3. Understanding the context

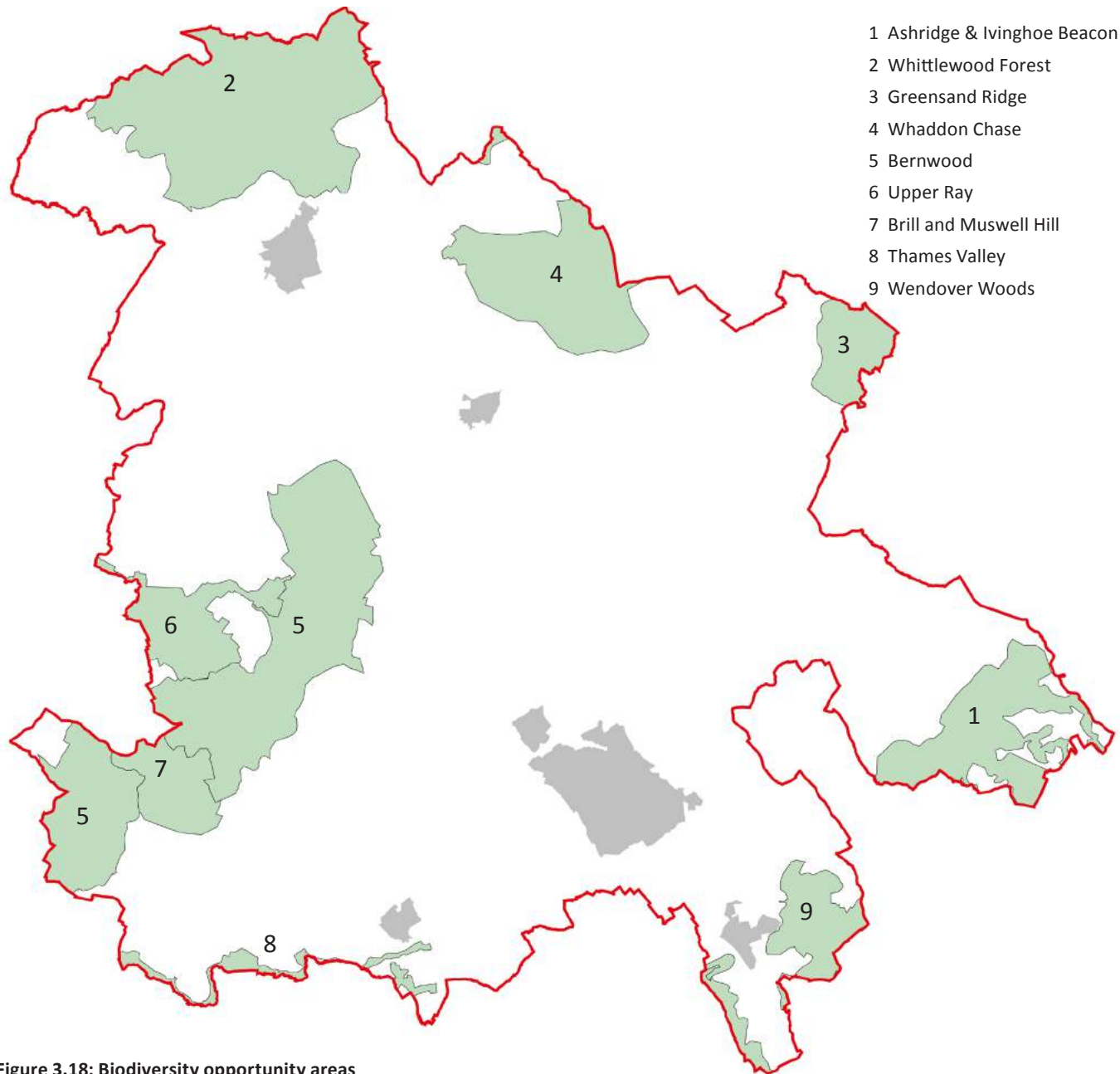

Figure 3.18: Biodiversity opportunity areas

3.4.6 Traditionally, nature conservation has focused on protecting important sites, however these sites are still fragmented and isolated from one another. Consideration is needed of functionally linked habitats - those areas beyond the boundary of a designated site which play an important role in maintaining the favourable conservation status of features and attributes for which a site was designated, for example by providing supporting habitats or regulating hydrological or nutrient cycles.

3.4.7 Certain habitats and species are protected by legislation, such as Great Crested Newts. Surveys show that Great Crested Newts are found in around a third of all ponds in Aylesbury Vale, higher than the national average. Natural England has granted Buckinghamshire Council a District Licence for Great Crested Newts as part of a regional conservation scheme. This is a streamlined process whereby developers do not need to commission newt surveys, as there has already been a wider regional assessment for the district licence. Developers need to apply to enter the district licensing scheme and present a district licence certificate or report (obtained through NatureSpace) to the Council as part of a planning application.

3.4.8 The Buckinghamshire and Milton Keynes Environmental Records Centre (BMERC) holds up to date records of designated sites, priority habitats and wildlife records. These records provide vital data to help inform decisions on development proposals and management of sites.



# 3. Understanding the context

## Settlement character

VALP Policy reference: S3

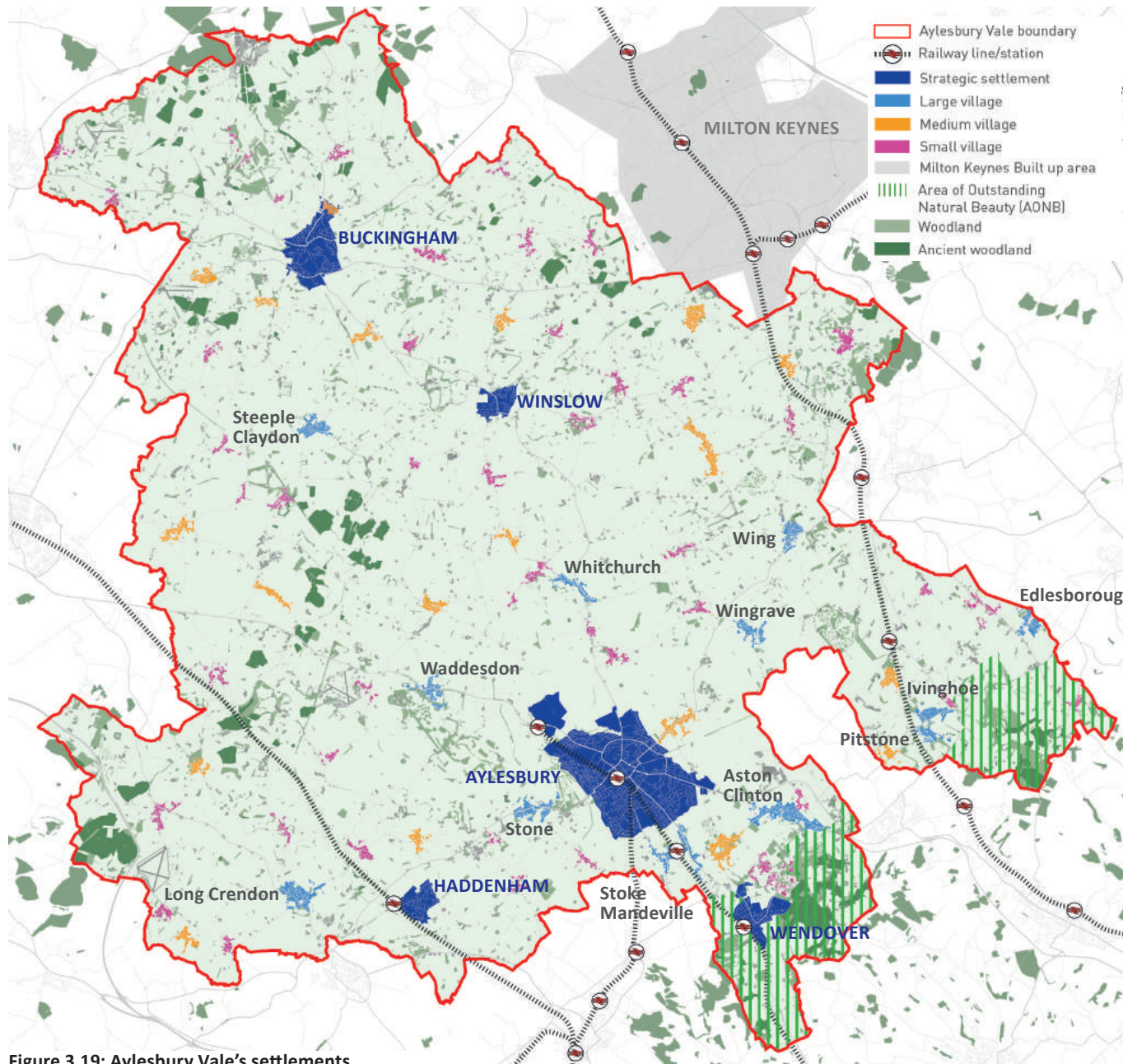

Figure 3.19: Aylesbury Vale's settlements

### 3.5 Settlement character

3.5.1 Aylesbury Vale has a distinctive settlement pattern of towns, villages and hamlets. Its largest settlements, Aylesbury and Buckingham are historic market towns serving a rural hinterland and with routes radiating from the centre. Many of the area's other settlements have grown around a road junction, or are linear in form with properties strung along one or both sides of a road. A large number of the settlements in Aylesbury Vale are historic and have conservation area designations.

3.5.2 Aylesbury Vale's distinctive and varied settlement form and character have also arisen from its history of development and the patterns and trends that have influenced it. Important factors include its agricultural history, such as parliamentary field enclosures and improved farmland, model villages and the influence of the Rothschild estate, and industrial development. Understanding these varied forms and the history which has created them is important when assessing the context and character of each place.

3.5.3 A settlement hierarchy is set out in Policy S3 of the Local Plan and this identifies six settlement categories. The settlement hierarchy is based on an assessment of population size, settlement connectivity, and the availability of employment and other services and facilities. Growth promoted in the Local Plan is distributed according to this hierarchy with the housing allocations generally greater in those settlements higher in the hierarchy where that development is more sustainable. The smaller settlements often have a close relationship with the surrounding countryside and this means that they are particularly sensitive to new development.

# 3. Understanding the context

## Principle DES4: Settlement and site context

Applicants should carry out a context appraisal that identifies the broad settlement context within which their site is located. This should form part of their character study and site appraisal (refer to Principles DES7 and DES8) and applicants must demonstrate how this has informed their development proposals.



### The urban context (fine grain)

3.5.5 The historic centre of many of Aylesbury Vale's settlements is characterised by a development pattern that is fine grain (i.e. composed of small scale development that has a predominantly vertical rhythm and which is characterised by tight street enclosure), and where a mix of uses provide activity and buildings tightly define a series of streets, squares, alleys and courts.

3.5.6 These areas are often rich in character and include historic buildings of heritage value and a high level of archaeological interest.

3.5.7 In some centres the fine grain development is mixed and includes development from a variety of historic periods including medieval, Georgian, Victorian and pre and post war buildings with shops, cafes and other active uses at the ground floor level. In these areas the quality of the built fabric varies and there may be scope for some modest change and intensification. However this would need to take into account the context and character of the area.

## Settlement character

VALP Policy references: S1; S3



### The urban context (coarse grain)

3.5.8 Aylesbury and Buckingham are also characterised by areas with a coarser grain with a less consistent built form. These areas include larger floorplate buildings of a greater scale and massing and a mix of uses including shopping centres, offices, food stores and apartment buildings.

3.5.9 The quality of the environment and the relationship of development to streets varies within these areas with buildings sometimes set within extensive surface car parks.

3.5.10 These areas may offer opportunity for change, intensification and improvement.

### Settlement contexts

3.5.4 The pattern of settlements gives rise to a number of broad character types across the area:

## 3. Understanding the context

## Settlement character

VALP Policy references: S1; S3



### Victorian / Edwardian urban streets

3.5.11 The edge of some town and village centres features Victorian residential streets often as a legacy of the coming of the railway to the area in the 19th century.

3.5.12 Generally properties in these areas are two storey, brick built, of a modest scale (frontage typically 4-6m wide and 8m deep) and laid out as terraces set close to the footway behind a small garden / privacy strip which is often defined by a low brick wall and occasional boundary vegetation. Car parking is generally on street.

3.5.13 Victorian villas are less common in the area. These properties are larger, often semi-detached but again front onto streets behind a small garden.

3.5.14 Victorian / Edwardian streets are urban in character and laid out as part of a gridded structure of perimeter blocks and connected streets with medium densities of 30 to 50 dwellings per hectare.

### Suburban context

3.5.15 Much of 20th and 21st century development in Aylesbury Vale is suburban housing found in the towns and larger villages.

3.5.16 The character of these areas varies from place to place but many are laid out as a disconnected network of streets accessed off an estate road and often the streetscape is dominated by car hard standings and lacking street trees and garden vegetation. Whilst buildings usually front the streets, frontages are sometimes fragmented by gaps and buildings are often too loosely grouped, too far apart or of insufficient height to enclose the street space.

3.5.17 Suburban residential densities are normally between 20 and 35 dwellings per hectare.

### Lower density suburban

3.5.18 The low-density areas are characterised by large residential properties set within often well-vegetated, generous plots. In these areas, the landscape and mature vegetation is an important component of the area's character. Residential densities within these areas are typically less than 20 dwellings per hectare.

3.5.19 This character type can be found towards the edge of the main towns and villages and largely originates from the post-war years through to the 1990s.

## 3. Understanding the context

## Settlement character

VALP Policy references: S1; S3



### Traditional rural village context

3.5.20 Villages set within the wider countryside are often located at the intersection of routes (nucleated settlements e.g. Brill or Quainton) or extending along a route (linear settlements e.g. Stewkley and Grendon Underwood) and display both rural and urban qualities.

3.5.21 Buildings are tightly clustered to define space in key locations such as around nodes, main streets and defining important spaces (eg village greens) often with large scale mature trees.

3.5.22 The relationship of the dwellings to the landscape is important within these settlements with properties taking advantage of views to the open countryside and trees an important feature. Densities generally reduce towards the settlement edge.

### Rural dwellings hamlets and farmsteads

3.5.23 The countryside features isolated dwellings, country estates and small groups of dwellings such as hamlets and farm buildings. In these locations the surrounding landscape is the dominant feature.

3.5.24 Aylesbury Vale has retained a very good number of early large farmhouses. Some survive from the medieval period, though most appear to date from the sixteenth century. In common with much of the South East of England farm buildings arranged in loose courtyard plans is the predominant plan type for medium to large farmsteads.

### Industrial estates / business parks

3.5.25 Within Aylesbury Vale there are a number of industrial estates and business parks often based on former clusters of agricultural buildings. These present a different urban condition where large floor-plate sheds set within yards and served by estate roads predominate. They provide an important part of the local economy but often present a poor quality pedestrian environment that is unattractive to move through and when located within open countryside can have significant visual impact.

3.5.26 These estates may present opportunity for redevelopment to deliver more attractive and efficient layouts where the employment uses interface better with adjacent residential neighbourhoods or the wider landscape and where there is potential to improve the quality of the pedestrian environment and experience.

# 3. Understanding the context

## Aylesbury Garden Town

VALP Policy reference: D1

### 3.6 Aylesbury Garden Town

3.6.1 Aylesbury is by some way the largest settlement within Aylesbury Vale and the County Town of Buckinghamshire with a resident population of 71,500 (2011 Census). With its origins as a Saxon settlement it became an administrative centre for the wider area in medieval times with its market serving as a focal point. Aylesbury grew through the 19th century with the coming of the railway and Grand Union Canal. However the population of the town was still under 10,000 at the beginning of the 20th century.

3.6.2 Aylesbury was designated as a London overspill town in the 1950s and grew at a rapid rate, expanding along radial routes and then ringing the town with residential suburbs, most recently at Berryfields and Kingsbrook.

3.6.3 Aylesbury was awarded Garden Town status by the Government in January 2017 as part of a wider programme of Garden Communities. The programme seeks to evoke a number of principles that were prevalent in the British Garden Cities movement a century ago and that led to places such as Welwyn and Letchworth Garden Cities and inspired the new towns of the mid-20th century.

3.6.4 This 21st century programme has been informed by work undertaken by the Town and Country Planning Association (TCPA) over the past decade.

3.6.5 This is articulated in their “Garden City Principles” which set a framework that new communities should accord to.



#### Garden City Principles (TCPA)

“A Garden City is a holistically planned new settlement which enhances the natural environment and offers high-quality affordable housing and locally accessible work in beautiful, healthy and sociable communities. The Garden City Principles are an indivisible and interlocking framework for their delivery, and include:

- Land value capture for the benefit of the community
- Strong vision, leadership and community engagement
- Community ownership of land and long-term stewardship of assets
- Mixed-tenure homes and housing types that are genuinely affordable
- A wide range of local jobs in the Garden City within easy commuting distance of homes
- Beautifully and imaginatively designed homes with gardens, combining the best of town and country to create healthy communities, and including opportunities to grow food
- Development that enhances the natural environment, providing a comprehensive green infrastructure network and net biodiversity gains, and that uses zero-carbon and energy-positive technology to ensure climate resilience
- Strong cultural, recreational and shopping facilities in walkable, vibrant, sociable neighbourhoods
- Integrated and accessible transport systems, with walking, cycling and public transport designed to be the most attractive forms of local transport”

Figure 3.20: Garden City Principles - Town and Country Planning Association (TCPA)

# 3. Understanding the context

## Aylesbury Garden Town

VALP Policy reference: D1

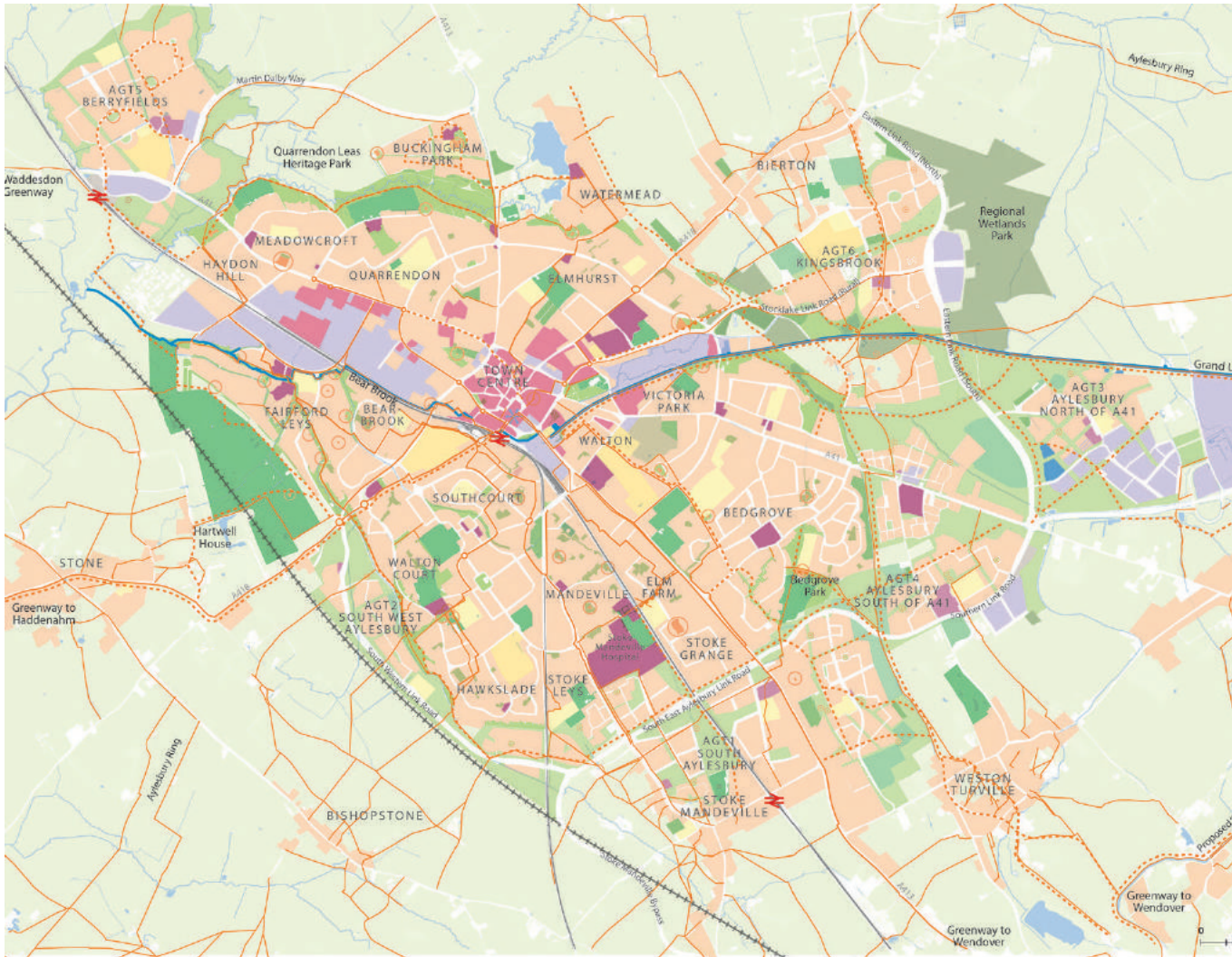

- Green Infrastructure**
- Public Open Space (informal green space, wildlife areas, recreation areas, woodland and parkland)
- Outdoor sports/playing fields
- Allotments and community orchard
- Ecology mitigation land
- Watercourse
- Play area
- Bus station
- Train station
- Proposed HS2 route
- Existing active travel routes
- Proposed active travel routes
- Residential
- Mixed use town centre/retail
- Mixed use local centre/community facilities
- Commercial: office, employment, industrial
- Primary school
- Secondary/higher education

Figure 3.21: Aylesbury Garden Town Plan

3.6.6 The Aylesbury Garden Town (AGT) will be the focus for the majority of the area’s growth. Over 16,000 new homes, together with significant new employment space, is proposed with the majority to be delivered on six large allocated sites at the edge of the built up area.

3.6.7 VALP Policy D1 principle (a) requires development in the AGT to create “distinctive, inclusive sustainable, high quality, successful new communities which support and enhance existing communities with the highest quality, planning, design and management of the built and public realm”.

# 3. Understanding the context

3.6.8 The vision for the Aylesbury Garden Town (AGT) is set out in the AGT Masterplan. It focuses on the whole town in an holistic way to ensure that:

- Aylesbury town centre will be a thriving civic and commercial heart and a destination for exchange, commerce and leisure;
- Local and neighbourhood centre and community facilities are available for everyone and support the highest quality of life;
- A web of green and blue infrastructure provides the ‘garden’ in Garden Town;
- People choose to walk, cycle or use public transport for everyday journeys and that streets are people friendly places no longer dominated by traffic;
- The garden communities will provide varied and beautiful neighbourhoods each with a distinctive design and character and that Aylesbury will be a showcase for new approaches to housing and delivery;
- Aylesbury will be a competitive place to do business and a core component of the Oxford to Cambridge corridor well connected to London and the Thames Valley; and
- Integration of smart and low carbon technologies will create a more resilient and sustainable place.

3.6.9 The AGT Masterplan identifies the provision of a “connected network of multi-functional blue and green infrastructure” as being central to the identity of Aylesbury as a Garden Town and recognises the role of green infrastructure within the urban environment in contributing to the ‘Garden Town’ character through provision of “leafy streets, plentiful outside space and a high quality public realm”.



Figure 3.22: Exchange Street, Aylesbury with enhanced public realm and new buildings providing frontage to streets (Credit: Alan Baxter Ltd / Prior and Partners)

3.6.10 Further details about the Aylesbury Gardens Town site allocations and the design and delivery principles are set out in Policy D1 and the relevant site policies in VALP. Additional site specific guidance is provided in the AGT masterplan.

### Principle DES5: Aylesbury Garden Town

Applicants with sites within Aylesbury Garden Town must familiarise themselves with the vision and design principles set out in the Aylesbury Garden Town masterplan and ensure that their development proposals are designed in accordance with both the recommendations within that document and this Design SPD.

# 3. Understanding the context

## Local distinctiveness VALP Policy references: BE2; BE4; D3; NE4



### 3.7 Local vernacular and distinctiveness

#### Principle DES6: Responding to local vernacular and distinctiveness

Local distinctiveness and identity forms part of the character of a place. Applicants will be required to demonstrate what makes the application site locally distinctive through survey and analysis, and how this has informed the design process and development proposals.

**'Local Distinctiveness is concerned with celebrating the unique characteristics of a place and with demanding the best of the new, so that quality and authenticity adds richness to our surroundings making them convivial to us and to nature.'**

Common Ground, 1985

3.7.1 Local distinctiveness is the essence of what makes a place special, differentiating it from anywhere else. It is the sum of cultural and non-cultural landscape, wildlife, archaeology, history, traditions and events, ambience, dialects, buildings and crafts – everything that makes somewhere truly unique. It is also connected with people's memory of a place.

3.7.2 New developments within Aylesbury Vale should reflect local distinctiveness to reinforce the area's unique sense of place, particularly in terms of layouts and how they respond to landscape and topography, design of new buildings, use of materials, colours and textures. Understanding local distinctiveness applies to all development, whether new build, alteration, extension, repair or minor change and to all categories of development: industrial, commercial or residential.

#### Settlement structure and built character

3.7.3 The grain and layout of the site or area, its scale and density and its built form are key aspects of its distinctiveness which should be explored and understood before making any changes. Within the broader pattern of settlement form and structure, the form of individual buildings reflects local building traditions, changing technologies and building functions, use of materials, and historical economic and social status.

3.7.4 Researching the history and development of the place, which have created these forms, creates better-informed development with a deeper understanding of its context (refer to Section 3.5 Settlement character).



# 3. Understanding the context

## Local distinctiveness

VALP Policy references: BE2; BE4; D3; NE4

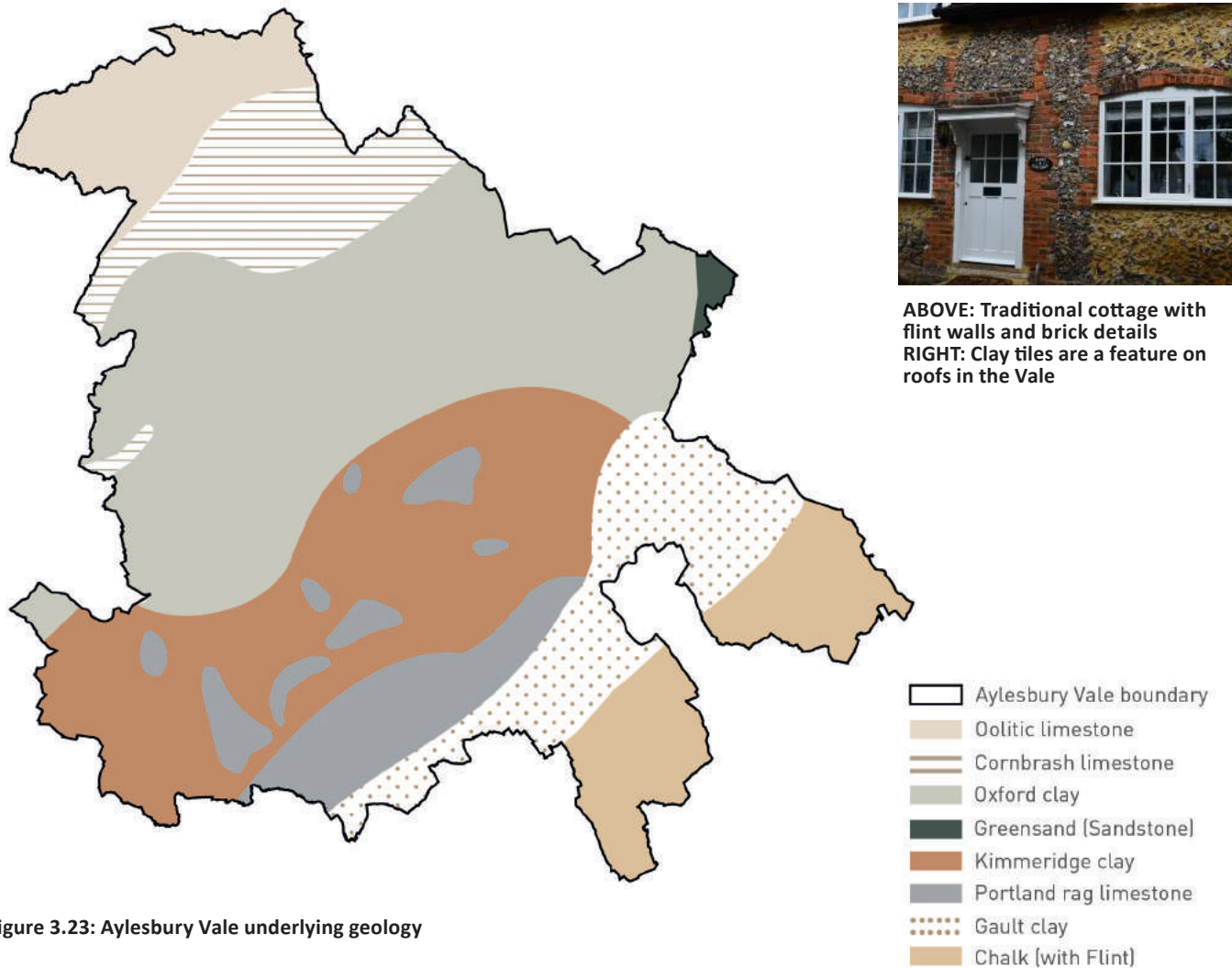

Figure 3.23: Aylesbury Vale underlying geology



ABOVE: Traditional cottage with flint walls and brick details  
RIGHT: Clay tiles are a feature on roofs in the Vale



### Geology and materials

3.7.5 Geology and landform make a distinct contribution to the landscape character of Aylesbury Vale and through the materials used within the settlements and landscapes of the Vale (Figure 3.23). Refer to the Buckinghamshire Mineral and Waste Plan which provides further information on the underlying geology of the area

3.7.6 Historically, the use of particular materials was localised, determined by availability and limited by the difficulty or the expense of transportation. Over the years, many individual settlements achieved an association with locally derived materials, which provide a distinct identity. The use of local materials gives a sense of place, continuity and permanence, which can assist in integrating new development into its surroundings.

# 3. Understanding the context

## Local distinctiveness

VALP Policy references: BE2; BE4; D3; NE4

### Local materials

3.7.7 The materials used in a development are important as they contribute to the overall appearance, can maintain and enhance local identity and connection to the surrounding landscape and enhance the character of a location.

### Brick

3.7.8 Between the limestone hills lie the clay vales where brick is the predominant building material. The texture, size and hue of these bricks varies throughout, especially where historically, bricks were manufactured locally and by hand. Before the mass production of bricks in the middle of the 19th century, there was no 'industry standard' for bricks resulting in differences depending on local clays, preferences and set up of local craftsman.

3.7.9 Bricks are the most widespread traditional building materials in Aylesbury Vale. Typically characteristic bricks are locally derived, relatively smooth faced and warm coloured, red-orange and red-brown. Parts of the Vale are still strongly associated with brick such as Brill, Hardwick, Whitchurch and Waddesdon. Brickyards in the Quanton / Westcott and Pitstone area produced a distinctive light yellow (Gault Clay) brick found in domestic buildings nearby.

3.7.10 There are many types of brick bonding used throughout the area and these will need to be considered when proposing new developments, particularly where alterations to existing buildings are planned. The type of bond enhances the overall appearance of buildings by adding texture and natural variations in colour.



Traditional limestone buildings

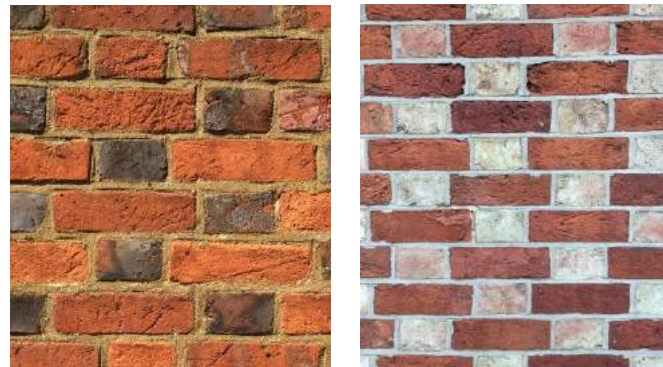

Historic Flemish bond predominates throughout the area where bricks are used, with variations in brick and mortar colour, such as in Buckingham and Winslow



Witchert building in Haddenham

3.7.11 Lime mortar is often used in historic buildings and can either complement or contrast with the colour and texture of the bricks being used. The use of lime mortar creates a traditional appearance but also has important physical properties, such as its porosity, which need to be taken into account. The use of the wrong mortar can cause rapid deterioration of historic brick and stone, resulting in a loss of authentic historic fabric and ultimately local character.

### Stone

3.7.12 Between the foot of the Chilterns escarpment and the dip slope of the Cotswolds rise a series of low limestone hills. These upland areas can be found in three distinct groups, the plateau north of Buckingham in the north west part of the District, the Brill-Winchendon hills, and the Quanton-Wing hills. Within these areas limestone is the predominant building material, particularly in villages such as Turweston, Shalstone, Oving and Thornborough. The exception are villages such as Brill that are predominantly red brick. Throughout these areas, lime mortar and red brick are combined.

### Witchert

3.7.13 Witchert is a naturally occurring mixture of clay and chalk which, when mixed with chopped straw and water, achieves a malleable substance and can be built up in layers (or rises) on a stone or rubble footing (grumpling) as a building material. Witchert is found in the vicinity of Dinton, Lower Winchendon, Haddenham, Long Crendon, Chearsley and Cuddington, as far north as Ludgershall and as far east as Bierton.

## 3. Understanding the context

3.7.14 Witchert is susceptible to erosion and weather protection is provided by copings and a lime plaster or lime wash over vertical surfaces. Originally, witchert walls were thatched and some have old plain tile copings, with pantiles being a later tradition.

### Timber

3.7.15 Wide timber boards are a traditional cladding feature used on barns and outbuildings, typically with a black colouration. They provide an excellent means of reducing the visual impact of garages and other ancillary structures.

### Flint

3.7.16 Flint from the Chilterns and the area west of Wendover is linked with the construction of buildings and boundary walls. 19th century farm buildings and churches frequently used flint with brick dressing and lime mortar. Both knapped and cobbled forms of flint construction are found within this part of the area.

### Render

3.7.17 Strong, but subdued shades, off coloured lime-wash (white or cream) is commonly used in rendered buildings which are found in many settlements across the area. Inappropriate use of modern paints has a negative impact on character and physical properties of render, resulting in damp issues and loss of historic fabric.



Varied roof pitches and materials, including thatch, tiles and harmonious coloured lime washed render

### Roofs

3.7.18 Roof shape, pitch and materials contribute to local identity. In Aylesbury Vale, the use of steep dual pitched roofs in clay plain tiles is seen on both old and recent buildings. Slate and clay pantiles are also widespread roof materials. There are a considerable number of thatched buildings throughout the area, with long straw material being the most traditional thatch type to the area.

3.7.19 Materials used for roofs are associated with different roof pitches. Thatch is rarely laid under a 50 degree pitch, slate is normally laid between 20 - 35 degrees, clay plain tiles are generally laid between 40 - 60 degrees and pantiles are usually laid at about 40 degrees.

3.7.20 Plain clay tiles are typically used on pitched roofs in the area, with slate tiles associated with re-roofing post the arrival of the railways or with Victorian development. Natural slate tiles are often seen combined with yellow bricks, plain or coloured render. Where roofs are hipped, bonnet tiles create a complete and harmonious appearance to the roof.

## Local distinctiveness

VALP Policy references: BE2; BE4; D3; NE4



Modern development using pale coloured render

### Modern materials

3.7.21 There are examples of commercial and industrial buildings in the area that owe their success largely to the skilful use of modern materials. New products should, however, be robust and capable of ageing and weathering in an attractive way.

3.7.22 In areas where there is a historic context, such as conservation areas, modern materials are often less satisfactory unless selected to complement, or otherwise be compatible with, existing traditional building materials, particularly those which give local character or identity. All proposed materials, whether traditional or modern, should be carefully selected using the Character Study and Site Appraisal to make informed choices, suitable for their specific location.

# 3. Understanding the context

## 3.8 Character study

### Principle DES7: Character study

Applicants should prepare a Character Study that identifies the context within which the application site is set. This should consider the structure and history of the settlement within which it is located or relates, the character of the landscape, the positive features within the streets and spaces and the built form. The study should also identify the emerging character arising from other proposed development.

The Character Study will help to guide and inform the proposals that are prepared later in the design process and applicants will be required to demonstrate how the study informs the design proposals.

The Character Study should identify the existing characteristics that can help to reinforce local identity and/or create a defined sense of place.

The Character Study will form part of the Design and Access Statement that supports a planning application.

3.8.1 The council will normally require a Character Study to be prepared to support any development proposal requiring a Design and Access Statement, irrespective of scale.



## Character study

VALP Policy references: BE1; BE2; NE1; NE4; NE8



3.8.2 The objective of the Character Study is to identify, analyse and describe in a systematic and objective way, those elements, or combination of elements, that have a positive role in helping to form the character of a place. Elements may be drawn from the immediate surroundings or (where relevant) from adjacent settlements or landscapes within Aylesbury Vale, taking care to focus on the traditional elements rather than inappropriate modern development.

3.8.3 The Character Study would form part of the Design and Access Statement submitted as part of an application.

3.8.4 The level of detail in the study should be related to the scale of the development proposals. For example:

- A proposal for an urban extension should be supported by a comprehensive study to consider the extension in the context of the existing settlement, its location in the wider landscape and its movement and green space network, carefully considering how the development would integrate with and enhance the settlement;

- An application for infill development or single dwelling may just consider the character of the street and the neighbouring properties to inform how the development can successfully complement the streetscene; and
- For sites located in areas where it may not be desirable to replicate or respond to the immediate character, applicants should consider adjacent areas or settlements and draw from those elements which help make Aylesbury Vale a distinctive place.

3.8.5 The character study should understand other development proposals that may be brought forward within the context of an applicants site.

3.8.6 The checklist at the end of Chapter 3 provides guidance on the appropriate scope and subject areas for the Character Study depending on the scale of the proposed development.

# 3. Understanding the context

## Site appraisal

VALP Policy references: BE1; BE2; NE1; NE4; NE5; NE8



### 3.9 Site appraisal

#### Principle DES8: Site appraisal

Applicants should carry out a Site Appraisal that identifies and illustrates the physical aspects of their site and identifies key constraints and opportunities that will help to inform their proposal.

The Site Appraisal will form part of the Design and Access Statement that supports a planning application (including outline, full or reserved matters applications) and will include proposal drawings, supporting text and illustrations that demonstrate that the site appraisal has been comprehensively undertaken.

3.9.1 Having identified planning designations relevant to their site and prepared a Character Study, applicants should then carry out a detailed Site Appraisal to consider the physical aspects of their site, including topography, drainage, existing natural features, and access points in order to identify the key constraints and opportunities that may impact on future development. This Site Appraisal would form part of the Design and Access Statement submitted as part of an application.

3.9.2 The objective of this Site Appraisal is to identify, in spatial terms, those constraints that will influence the design and the opportunities afforded by the site.

3.9.3 The scope and areas covered in the Site Appraisal should be related to the scale of the development proposals.

3.9.4 The checklist at the end of the Chapter provides guidance on the appropriate scope and subject areas for the Site Appraisal. This should not be considered as an exhaustive list of the constraints and opportunities but rather a starting point for consideration.

#### Potential constraints and opportunities for consideration as part of the Site Appraisal

This is not an exhaustive list but a starting point for consideration:

- Topography and views;
- Geology, ground conditions / contaminated land;
- Site orientation and microclimate;
- Air quality and noise;
- Drainage, hydrology and flood risk;
- The location and capacity of existing services;
- The history and heritage of the site and the potential for significant archaeological artefacts;
- Heritage designations including Conservation areas, Listed Buildings and Registered Parks and Gardens
- Adjacent land uses and sensitivities including adjacent dwellings that may impact site potential or overlook the site;
- Existing landscape features (including trees) that are of value;
- Trees and vegetation covered by Tree Preservation Orders (TPO's), conservation areas, or Hedgerow Regulations;
- Habitats, protected species and any features that contribute to biodiversity / potential to achieve net gain in biodiversity;
- Site access by all modes of transport; and
- Rights of way or opportunities to connect and integrate with the existing development pattern.

Refer also to the checklist at the end of Chapter 3.

# 3. Understanding the context

## Checklist

### How to use

This table provides a checklist of things to consider when preparing a **Character Study**. The checklist should be used by applicants and planning officers as prompts when preparing the Character Study.

Subject	Description	Consideration	Check
<b>Wider setting</b>	What is the wider setting of the site and the location of the settlement in relation to other settlements within the region?	Function of the settlement and relationship to adjacent areas	
	What is the wider context within which the site is located?	Settlement + site context (Principle DES4)	
<b>Settlement structure</b>	How is the settlement within which the site is located structured and laid out and where does it connect to? Does it have a linear structure along a main route or is part of a grid of streets for example?	Historical development and layout	
	What is the existing and emerging hierarchy and network of streets and spaces within the settlement and how does this contribute to its character?	Structure and hierarchy of streets and spaces	
	Are there any places or uses that provide a focus for the settlement?	Identity	
	What is the prevailing density of the settlement? Does it vary and what would be appropriate for the application site or for different parts of the site?	Density of development	
	How does the existing settlement mark arrival points or the meeting of routes? Can this be drawn upon to mark gateways and nodes within the proposal?	Gateways and nodes	
	How large are existing plots or blocks within the settlement? Is the pattern regular or irregular?	Plot and block size	
<b>Landscape character/ natural features/ topography</b>	What is the landscape character, underlying geology and landform and how might this influence the development? Are there particular landscape, arboricultural, ecological or geological characteristics that give a place its essential character?	Landscape and settlement character (Principle DES2 and DES4)	
	Are there landscape features (trees, hedgerows, ecological or geological), within the site that give the place its character and how can these be incorporated into the proposals?	Existing landscape features, water features, trees, hedges	
	Are there any important views to and from the site and beyond that are valuable and should be retained? Understanding how the new development will be perceived from the surrounding area.	Views and skyline	
<b>Streets and public spaces</b>	What is the prevailing level of enclosure for existing street types within the settlement? Does this contribute to their character? How are spaces enclosed?	The containment of streets and public open spaces	
	Are there particular public realm characteristics, such as planting, form, materials to draw influence from?	Layout and form of spaces	
	How does the interface between private and public spaces contribute to the settlement's character?	Public and private space interface	
	How does public art contribute to the settlement's character?	Public art	
<b>Built character</b>	What is the existing and emerging local built character and form (both plan and 3 dimensionally) and building uses and how do buildings relate to each other. How does this provide cues for appropriate design forms?	Scale, form and massing and building use (Principle DES6)	
	Does the building frontage define the public realm or are there front gardens? What are the prevailing boundary treatments?	Treatment of building frontages and boundaries (Principle DES6)	
	Are there common building types prevalent within the settlement? Can these be re-interpreted?	Building types (Principle DES6)	
	Are there common building materials within the settlement which would be relevant to the proposal?	Use of materials (Principle DES6)	

# 3. Understanding the context

## Checklist

### How to use

This table provides a checklist of things to consider when preparing a **Site Appraisal**. The checklist should be used by applicants and planning officers as prompts to identify **Constraints and Opportunities** for all sites.

Subject	Component	Site Appraisal	Check
<b>Physical Environment</b>	Topography and views	What is the topography of the site and how will this influence the proposals? How is the site viewed or overlooked from afar? Are there prominent overlooked areas that may be best left undeveloped? How can the development provide a well-defined external image to the countryside?	
	Geology, ground conditions and contaminated land	What is the existing geology of the site? Are there areas of the site which are difficult to build on, contaminated or potentially contaminated or less porous than others?	
	Orientation and microclimate	How is the site orientated? Can this be capitalised on?	
	Air quality, noise	Are there areas of the site which are affected by noise or poor air quality such as adjacent to major strategic roads or rail infrastructure or existing cultural or community buildings? Are there areas of the site which are within or near an Air Quality Management Area?	
	Drainage and hydrology	How does the site currently drain? Are there locations where water collects? Are soils permeable? How will this affect the proposals and the potential for sustainable drainage systems?	
	Flooding	Are there areas of the site within the flood plain? Are there areas of the site prone to fluvial, surface water and/or groundwater flooding?	
	Services	Are there existing services and/or capacity to serve the development? Are there any existing utilities or service infrastructure that may constrain your development. For instance overhead power lines or a significant sewer.	
<b>Heritage</b>	Designated and non-designated heritage assets	Are there any listed buildings, conservation areas, scheduled monuments or registered parks and gardens on site or is the site in the setting of any of these heritage assets? Are there likely to be any archeological remains within the area? Are there any non-designated assets on or adjacent to site? Is the site located within the setting of a designated or non-designated heritage asset? Are any studies required?	
<b>Landscape</b>	Trees and vegetation	Are there any trees on or adjacent to the site with Tree Preservation Orders? Is the site located in a conservation area? Are there any hedgerows that could be protected under the Hedgerow Regulations? Has a tree survey to BS5837:2012 (or most recent equivalent) been carried out?	
	Existing features	Are there any existing features such as trees, hedgerows, watercourses, or areas of woodland that contribute to the sites amenity value and should be retained?	
<b>Ecology and biodiversity</b>	Priority habitats and species	What is the existing biodiversity value of the site? Are there particular areas or features which have a high biodiversity value that should be protected? Is there opportunity for habitat creation and enhancement?	
<b>Highways</b>	Site access by all modes	What are the existing access arrangements for the site? Does an alternative means of access have to be introduced?	
	Connections and Links	Are there existing rights of way across the site? Can the site connect back to an existing neighbourhood and be integrated with an existing street network? What existing cycle infrastructure is there? Can a footpath be upgraded to bridleway to accommodate cycling access?	

# 3. Understanding the context

**How to use**

This table provides a checklist for use by both the applicant and planning officer to check that appropriate consideration has been given to how an application responds to its setting.

**PROCESS:** Have you:

- Identified all planning designations;
- Considered the character of the site within its settlement and prepared a Character Study; and
- Carried out a detailed Site Appraisal and established the constraints and opportunities that apply to the site.

The adjacent table summarises the key principles set out within this section and can be used by both the applicant and officer.

Applicants will be expected to demonstrate to the council that they have responding adequately to all relevant principles in preparing their proposals.

Principle	Description	Check
<b>DES1: Designations</b>	Has the applicant clearly identified whether the site lies within or adjacent to any area with a statutory or non-statutory planning designation?	
	Has the applicant understood the implications of these designations on the development of the site?	
<b>DES2: Landscape Character</b>	Has the applicant carried out an evaluation of the landscape character of their site and its setting?	
<b>DES3: Ecology</b>	Has the applicant identified whether priority habitats or protected species lie within or adjacent to the site?	
	Has the applicant demonstrated how the development design will protect, enhance, create and connect biodiversity to support coherent and resilient ecological networks?	
	Has the applicant identified the opportunities for new development to achieve biodiversity net gain following the mitigation hierarchy?	
<b>DES4: Settlement and site context</b>	Has the applicant identified the potential opportunities for new development to make a positive contribution to the character of a settlement?	
<b>DES5: Aylesbury Garden Town</b>	Is the site within the Aylesbury Garden Town? Has the applicant understood the AGT vision and principles that also apply to their proposals?	
<b>DES6: Responding to local vernacular and distinctiveness</b>	Has the applicant identified the local vernacular and the characteristics that makes the area within which the site is located distinctive?	
<b>DES7: Character Study</b>	Has the applicant carried out a Character Study and covered the topics set out in the relevant checklist?	
<b>DES8: Site Appraisal</b>	Has the applicant prepared a detailed Site Appraisal and identified the constraints and opportunities that apply to their site?	

**SUMMARY:** At this stage the applicant should have a full understanding of their site and its context. This work should be undertaken before developing design proposals.



### 3. Understanding the context

This page is intentionally left blank



# 4

## Establishing the structure

Getting the structure of development right – the layout of streets, landscape, land uses and buildings and how they integrate with the surrounding area is crucial to creating successful, attractive and sustainable places. The places we love to live, work and visit usually have robust structures that define the character of the place. All too often new development lacks this coherent structure and therefore lacks a sense of place.

It is critical when planning large-scale development that the principles of place-making are carefully considered and implemented. This means considering the street layout and connectivity, the land uses, landscape and buildings in an holistic manner.

This chapter explains how applicants should translate their understanding of context into the establishment of a structure for their proposed development.



## 4. Establishing the structure

### Natural resources

VALP Policy references: NE1; NE2; NE6; NE8; I1



Figure 4.1: INDICATIVE SITE CONCEPT PLAN 1 - Identifying natural features and resources

#### 4.1 Natural resources

##### Principle DES9: Work with the natural features and resources of the site

Natural resources are the assets or raw materials found in the land and water including soils, vegetation and animal life. They provide vital services such as pollination and water purification and also wider benefits for placemaking and health and well-being.

The existing landscape structure and physical characteristics including geology, landform, watercourses and drainage, field patterns, vegetation and trees should be considered by applicants from the outset when developing a proposal for their site.

Priority habitats and locally distinctive features, such as those listed below, should inform development layouts and be retained and incorporated into the landscape structure:

- Waterbodies;
- Woodland;
- Trees;
- Hedgerows;
- Traditional orchards;
- Meadows;
- Wetland;
- Fens;
- Heathland;
- Open mosaic habitats; and
- Arable field margins.

## 4. Establishing the structure

### Reason

4.1.1 Existing natural resources and features are valuable and irreplaceable assets of every site and the wider environment, contributing to the overall character and sense of place. The value of existing trees, vegetation and hedgerows should be recognised by the applicant, as they provide landscape continuity, history and value as the basis for a scheme as well as giving proposed new development an immediately mature element. As such retention and enhancement should always be the preferred solution and in some cases will be required as set out in VALP policy NE1.

4.1.2 Trees, hedgerows and other forms of vegetation also provide biodiversity and wider ecosystem benefits, and therefore any removals should only be considered where retention isn't possible and they must be compensated with an appropriate replacement. The Mitigation Hierarchy Guide should be used in the approach to existing natural resources of a site following the four steps to firstly avoid, then minimise, restore and lastly, offset. Application of the hierarchy should result in the incorporation of trees and vegetation into the design, with an overarching aim for net gain in biodiversity.

4.1.3 Trees, planting, hedgerows, open landscape and ditches not only provide ecological benefits, but can provide a helpful structure to new development whilst enhancing its setting and reducing impacts on the wider landscape. Ponds and watercourses are beneficial features for enhancing views and outlook, whilst specimen trees draw visual focus and provide landmarks in new development. Any new planting should have a clear design objective which takes a 'right tree, right place' approach whilst not adversely impacting on biodiversity.

4.1.4 Important existing uses and functions of a site should be incorporated into a development through new or retained buildings, or landscape features. This includes existing informal routes and desire lines which should be acknowledged and potentially formalised.

4.1.5 Site constraints and opportunities should be considered from the outset of a project, with every effort being made to avoid disruption to below ground archaeology. Where possible, overhead electricity lines should be relocated underground, and along with other utilities, should be aligned with streets for ease of access and to avoid restrictions on planting in areas of open space.

4.1.6 Best practice guidance includes 'Biodiversity Net Gain: Good Practice Principles for Development, A Practical Guide' and 'Trees, Planning and Development A Guide for Delivery'.

## Natural resources

VALP Policy references: NE1; NE2; NE6; NE8; I1



Levels and grading around an existing retained tree were poorly resolved leaving the tree on an 'island'

### Principle DES10: Respond to topography and strategic views

All development, including residential, large scale transport infrastructure and communications corridors should use the existing topography of Aylesbury Vale as a framework for structuring the layout of a site.

Applicants should identify important views into and out of their site. This may include long distance views to landscape features or buildings, or shorter distance views to attractive or distinctive townscape. Development should be laid out so that these views are retained and where possible enhanced, to both improve legibility and the setting of development. New development should be structured to retain visual connectivity to adjacent features which will enhance legibility and identity.

Applicants should avoid siting buildings on the highest part of a site, using the natural shape of the land to help visually contain and soften the appearance of the development, avoiding breaking the skyline or ridgeline of hills. New development should not cause significant negative impacts particularly to and from the Chilterns AONB, or any other sensitive viewpoints.

Development should be grouped with existing buildings where possible to minimise visual intrusion, and any adverse effects regarding on-site and off-site views towards important features and landmarks should be limited.

Applicants should also consider how landform and topography will influence surface water collection and structure their development proposals to respond to this.

The spacing, height, scale, plot shape and size, elevations, roofline and pitch, overall colour palette, texture and boundary treatment of any development should be carefully considered.



Panoramic view northwards over the Thames Valley from the A418 Ridge

### Reason

4.1.7 Aylesbury Vale has a distinctive landscape of low undulating topography dissected with ridges of higher ground which provide attractive views across the open countryside. Views to and from The Chilterns AONB are particularly important for developments surrounding Aston Clinton, Aylesbury, Cheddington, Stoke Mandeville, Wendover, Weston Turville, all of which have public vantage points towards the AONB.

4.1.8 Careful consideration needs to be given to the topography of a site, and how the natural landform can determine views in and out. The visual connectivity to a site's surroundings can be enhanced through careful layout and massing design, with viewpoints and landmarks an essential consideration. Use of the surrounding landscape as an asset can help enhance the character of the development.

4.1.9 Natural landform should be analysed and considered to determine overall structure of development, views in and out of site, movement and recreational routes, building orientation and massing of development. Local changes in landform levels can either visually contain or increase visibility of development, determining the overall visual impact on surrounding neighbours. Existing landform of an area and its natural pattern of drainage should be investigated and reflected within a site's sustainable drainage (SuDS) system.

## 4. Establishing the structure

### Principle DES11: Establish a landscape and green infrastructure network

Existing green infrastructure and features on site should be identified and incorporated into scheme design. Green infrastructure adjacent to a site should also be identified and applicants should consider how new features on a site connect to the existing features both on and off site, to create a connected network of landscape and green infrastructure.

The structure and form of landscape and green infrastructure should be planned for at the start of a project and inform the layout of the development. Centrally located public open space and green infrastructure within a safe location that is overlooked, is preferred. Locating green infrastructure on the edges of a site should be avoided unless there is a need to create a buffer and it is appropriate to the context.

Applicants should create links between existing and proposed green infrastructure to further establish a high quality, multi-functional, accessible and connected network, with a clear role and purpose for each space to meet local needs.

Landscape planting should be native and use locally appropriate species, for example black poplar planting in boggy areas near ditches and floodplains. Edible landscapes should be encouraged. Heritage fruit and tree planting including orchards and species such as the Aylesbury prune or walnut, should be considered by applicants where appropriate.

### Reason

4.1.10 There is a deficiency in green infrastructure in Aylesbury Vale, both in quantity and accessibility. In 2019, 69% of dwellings in the area did not meet Natural England's Accessible Natural Green Space standards. Two priority areas have been identified at North Aylesbury Vale and Aylesbury Environs, however all development over the minimum threshold must meet the minimum requirements set out in VALP policy I1 and appendix C.

4.1.11 Green infrastructure has a multitude of benefits, including, but not limited to providing recreation opportunities, visual amenity, creating habitats for wildlife, urban cooling, air quality regulation, adapting to and mitigating climate change, providing surface run off control, enhancing connectivity and through this encouraging walking and cycling, as well as having a positive impact on people's health and well-being.

4.1.12 Applicants should refer to the Buckinghamshire and Milton Keynes Natural Environment Partnership's "Vision and principles for the improvement of Green Infrastructure in Buckinghamshire and Milton Keynes" and / or any subsequent evidence published by the Council.

4.1.13 A network of connected green spaces should be proposed through larger development sites, strategically located to maximise the benefits of existing green infrastructure and include open spaces which are centrally located within new development. This network should respond to, and soften the impact of development on, the surrounding area and existing heritage or landscape assets, and link to existing woodland, hedgerows and vegetation adjacent to site.

## Green infrastructure

VALP Policy Ref: NE1; NE2; NE6; NE8; C4; C6; I1



Homes overlooking a biodiverse wetland area

4.1.14 The quality of all public open space should be driven through the aim to achieve Green Flag Status.

4.1.15 It is recognised that some species and habitats are particularly sensitive and some sites may not be suited to multi-functional uses including access. Care should be taken to reduce disturbance at these sites and to direct visitors to alternative green spaces to alleviate pressure.

4.1.16 Applicants should also use the Aylesbury Vale Green Infrastructure Strategy to inform and guide their decisions. The GI Strategy identifies ten local flagship projects which illustrate how to achieve multi-functional green infrastructure. The Buckinghamshire Green Infrastructure Delivery Plan includes proposals for Aylesbury Linear Park and Whaddon Chase, and new development around the area should deliver green infrastructure in line with both of these documents.

## 4. Establishing the structure



Figure 4.2: INDICATIVE SITE CONCEPT PLAN 2 - Establishing a green infrastructure network

A network of connected open spaces is proposed through the site.

These are strategically located to:

- Maximise the benefits of existing green infrastructure;
- Provide open spaces within the heart of the new development
- Respond to, and soften the impact of development on existing heritage assets;
- Link areas of woodland to the north and south of the site; and
- Protect, enhance, create and connect biodiversity.

## Green infrastructure

VALP Policy Ref: NE1; NE2; NE6; NE8; C4; C6; I1



### Case study: East Walworth Green Links

Created by the 'friends of the park' groups, as part of Southwark's 'Living Streets' programme, the East Walworth Green Links project provides an alternative way of travelling between six parks from The Elephant & Castle to Burgess Park, linking the smaller parks on the way. For those on foot or bike, and the wildlife, the green link offers safety, quietness, greenery, cleaner air and relaxed travel.

Each of the parks provide a unique set of functions and variety of uses such as play areas and picnic spots, a pavilion and café, sports areas, pitches, courts and community sports centre, tennis courts, BMX track, outdoor gyms, youth shelters, and a viewing hill. There are memorial spaces and peace gardens for reflection and contemplation, as well as a history trail to aid interpretation of the cultural heritage of the area.

The Green Link provides a range of habitats, such as meadow, native and mature trees, rain gardens and water features, nature garden, semi-wild areas with fruiting and native species, relaxed maintenance wildlife areas, world plant borders, as well as community orchard and vegetable gardens.



## 4. Establishing the structure

## Blue infrastructure

VALP Policy Refs: NE1; NE2; NE6; I1; I4

### Principle DES12: Water features and sustainable drainage systems

Water features and Sustainable Drainage Systems (SuDS) are an important element of public realm and should be incorporated into site structure from the outset. Where possible, existing watercourses and other surface water features should be used as a framework for the site layout and SuDS design, incorporated in accessible and central locations.

Site constraints should be considered and where woodland and/or root protection zones are present, SuDS should be relocated to a more suitable area of the development. Evidence should be provided that any change to the water table does not adversely affect ancient woodland or ancient and veteran trees.

SuDS should not only enhance rainwater management, but provide improvements in water quality, visual amenity, reinforce the overall character of a site and enhance biodiversity. Above ground SuDS components should aim to create new habitats based on ecological context and site conditions. Areas of wet scrub and woodland, usually around larger detention and retention ponds and wet grassland can benefit a range of wildlife. SuDS features are likely to have greater species diversity if existing habitats are within dispersal distance for plants, invertebrates and amphibians.

SuDS should be designed with longevity and easy maintenance in mind and applicants should provide a management plan for their SuDS. Applicants are encouraged to use the SuDS guidance and pre-application advice service to identify any issues and risks from the outset. A variety of SuDS mechanisms should be implemented on site, following the SuDS management train where control at source is preferable. Applicants should also refer to the Buckinghamshire Council Biodiversity Net Gain SPD.

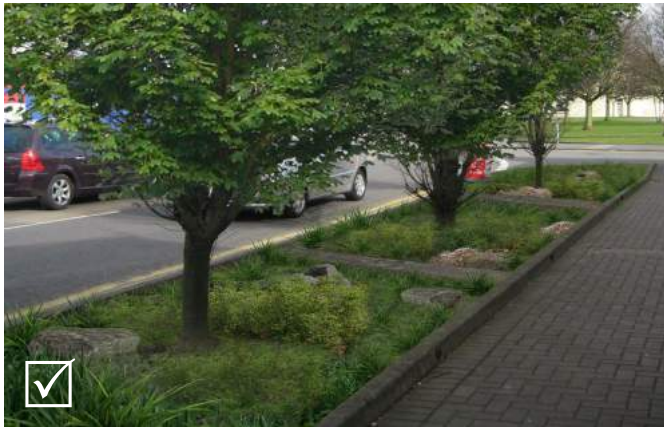

Figure 4.3: INDICATIVE SITE CONCEPT PLAN 3 - A sustainable drainage network incorporated within open spaces is proposed through the site

These are strategically located to:

- Manage extreme rainfall/ cloudburst events, reducing pressure on conventional drainage systems and preventing pollution events
- Maximise the benefits of existing green infrastructure
- Provide additional visual amenity, biodiversity and enhance character of the new development

## 4. Establishing the structure



Storm water rain gardens can be incorporated within the street design to attenuate rainwater

### Reason

4.1.17 Sustainable drainage and watercourses are efficient ways of managing water run-off from hard surfaces by reducing the stress put on conventional sewer systems during high rainfall events, therefore reducing the risk of flooding. The choice of materials, the balance between soft and hard landscape areas and the use of green roofs, rain chains, rain gardens, swales and attenuation ponds are important elements in drainage design that should be incorporated into developments.

4.1.18 SuDS should be designed to avoid engineered appearance and respond to natural context. These systems can provide resilience to climate change and make significant contributions to improvements in landscape character, biodiversity, water quality, local identity and can increase aesthetic value.



SuDS feature integrated within the streetscene in Upton, Northampton

4.1.19 Applicants should follow a rigorous process when preparing flooding and SuDS proposals:

- Pre-app consultation and initial guidance;
- Refer to existing guidance for major and minor applications (Lead Local Flood Authority);
- Desk study and site survey;
- Informed intelligent layouts;
- Integration of water features at the beginning, not driven by developable plot areas;
- Define ordinary watercourse and buffers, which in most cases are required by VALP policy NE2 to be 10 metres between the top of the watercourse bank and the development;
- De-culverting requires land ownership consent; and
- Consult with relevant bodies and authorities where applicable, including the Internal Drainage Board and the Canal and River Trust.

## Blue infrastructure

VALP Policy Refs: NE1; NE2; NE6; I1; I4



Pond on Walton Grove, Aylesbury provides focal point and attractive setting for adjacent houses



Attenuation pond is poorly integrated into the residential development so that it has limited visual amenity value

## Principle DES13: Design to enhance biodiversity

The principle of 'bigger, better and more joined up' should be followed to establish a strong and connected natural environment to enhance biodiversity. Design of development should:

- Achieve net biodiversity gain as a minimum standard for all development (the minimum % of net gain to be in line with legislation);
- Avoid harm and protect designated habitats, protected species and other flora and fauna;
- Follow the mitigation hierarchy by avoiding possible negative impacts on biodiversity as far as possible; and
- Follow the guidance set out in the Buckinghamshire 'Biodiversity Accounting Supplementary Planning Document' on how to calculate development impacts on biodiversity.

Landscape features which add ecological or habitat value to a site should be retained and enhanced. Development must retain and avoid priority habitats. For all other habitats, where this is not feasible evidence should be provided and suitable mitigation and compensation should be proposed. Compensation should be the last resort and habitats created should reflect the local context using native species of local provenance whilst prioritising protected species. Development must promote site permeability for wildlife and avoid the fragmentation of wildlife corridors, incorporating features to encourage biodiversity

New habitats should help achieve the targets set out in the Buckinghamshire and Milton Keynes Biodiversity Action Plan and support protected species. Applicants should also refer to the Buckinghamshire Council Biodiversity Net Gain SPD.



Open space designed for wildlife in collaboration with the RSPB at Kingsbrook, Aylesbury

### Reason

4.1.20 Green infrastructure is expected to positively contribute to the conservation, restoration, creation and enhancement of networks of biodiversity on a multi-functional landscape scale to maintain water-quality, manage inland flooding and enhance carbon storage, to deliver a more effective ecological network. Lawton's principle states that 'recovering wildlife will require more habitat; in better condition; in bigger patches that are more closely connected' (A Green Future: Our 25 Year Plan to Improve the Environment), and this approach should be applied to Aylesbury Vale. Small, isolated patches of habitat are more vulnerable to climate change, pests and disease, therefore connecting smaller pockets of habitats will help to preserve wildlife and allow it to flourish. The impact of climate change means that connecting corridors are needed to help build up much needed resilience.

## 4. Establishing the structure



4.1.21 Native planted buffers should be created adjacent to existing woodland (25 - 100 metre) as well as 5 - 10 metre buffers being retained or created around hedgerows. Natural England best practice defines that buffers of at least 15 metre should be provided between development and ancient woodland and at least 5 metre from the edge of the outermost tree canopy if this is larger than fifteen times the tree's diameter. Buffers should consist of semi-natural habitats of woodland, scrub, grassland, heathland and wetland planting as appropriate to the local habitat types and species and avoiding SuDS unless they are outside root protection areas and don't affect the water table. Buffers should be dark corridors with no lighting where possible, or include lighting designed to reduce wildlife disturbance. Domestic gardens should not be placed within buffers.

4.1.22 Ponds and other water bodies should be integrated into designs and managed appropriately to enhance wildlife and biodiversity.

4.1.23 Species focussed design should incorporate features within the built environment such as mammal runs, integrated bird and bat bricks, hedgehog holes and bee bricks, and should be included within planning applications.

4.1.24 Design for wildlife should include species-rich lawns, living roofs and walls, above ground SuDS components, and plants for pollinators and birds (such as fruiting and berry species).

4.1.25 Naturalising and re-wilding green spaces through relaxed management provides for habitats, wildlife and reconnects people with nature

4.1.26 Information boards explaining the reasons and the benefits of the area to wildlife and the role these areas play in the wider green infrastructure network should be provide where appropriate.

4.1.27 Best practice guidance is provided by the Natural Environment Partnership 'Incorporating Biodiversity & Green Infrastructure into Development.'

## Biodiversity

VALP Policy Refs: NE1; NE2; NE8



### Case study: Kingsbrook Aylesbury

The Kingsbrook development and its relationship with nature conservation, in partnership with the RSPB, shows how nature and housing can be better integrated. The development aims to provide 60% wildlife-friendly greenspace, excluding gardens, with new housing surrounded by ponds, parks, meadows, orchards and a nature reserve.

The RSPB joined forces with a national housebuilder to set a new benchmark for nature friendly housing developments – the first national agreement of its kind in the UK. At Kingsbrook, some 2,450 new homes, new schools and community facilities have been designed in a way that puts nature at the heart of proposals. Around 60% of Kingsbrook will be green infrastructure, including 250 acres of accessible, wildlife-rich open space, orchards, hedgehog highways, newt ponds, tree-lined avenues, fruit trees in gardens, bat, owl and swift nesting boxes and nectar-rich planting for bees.

## 4.2 Movement network

### Principle DES14: Establish a clear movement network that connects with the surrounding area

Applicants should design the layout of new development to:

- Link with existing routes and access points;
- Create direct, accessible, attractive and safe connections through the site for pedestrians, cyclists and vehicular modes which follow natural desire lines and connect to existing streets, open spaces, local facilities or destinations;
- Avoid turning heads by creating continuous vehicular routes around perimeter blocks;
- Carefully integrate public rights of way; and
- Respond to topography and landscape features; and
- Allow safe movement for wildlife and habitat connectivity.

The network should provide a choice of routes for all modes and follow a spatial and visual hierarchy, with the most direct routes reserved for sustainable modes in order to encourage use. The character of a street should reflect its position in this hierarchy and respond to local characteristics. Refer to Principles DES1-8)

While direct routes are most convenient, the design should also balance visual attraction, traffic calming and safety to optimise the pedestrians' and cyclists' experiences.

Whenever possible applicants should avoid promoting developments that are accessed off a single location or promote long culs-de-sac that do not provide a choice of direct and convenient routes.

The opportunity should be taken to make pedestrian / cycle connections between adjacent development sites whenever possible.

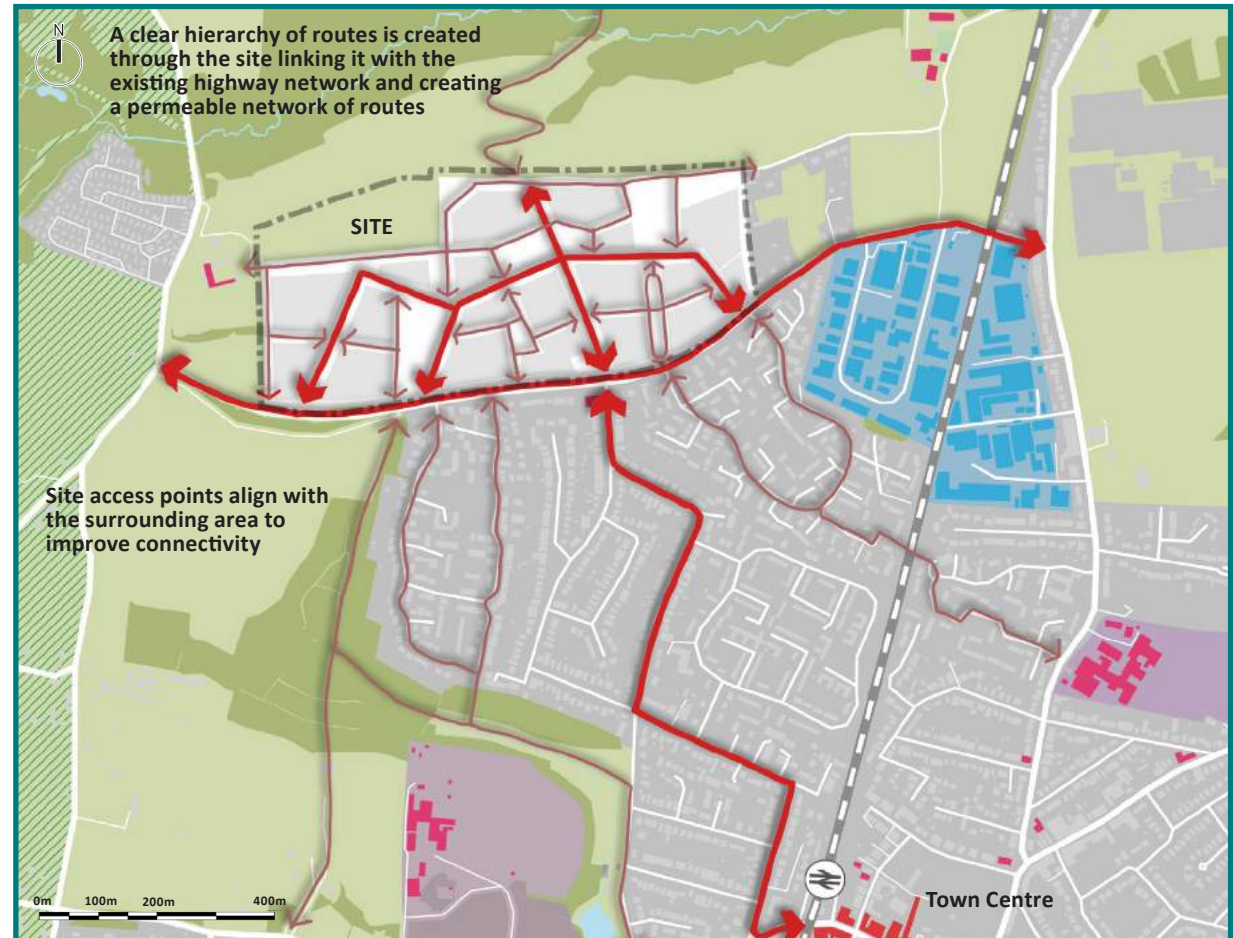

Figure 4.4: INDICATIVE SITE CONCEPT PLAN 4 - Establishing a clear movement network

### Reason

4.2.1 Successful places are easy to get to, easy to move through and easy to find your way around. A connected network of streets offers choice, aids legibility, avoids turning heads and other engineered solutions and provides a hierarchy of street types which respond to the function and role of the street.

4.2.2 Development will need to adhere to the Highways technical advice as set out in the Highways Development Management Guidance on the council website.

# 4. Establishing the structure

## Movement network

VALP Policy Refs: S1; T1; T7

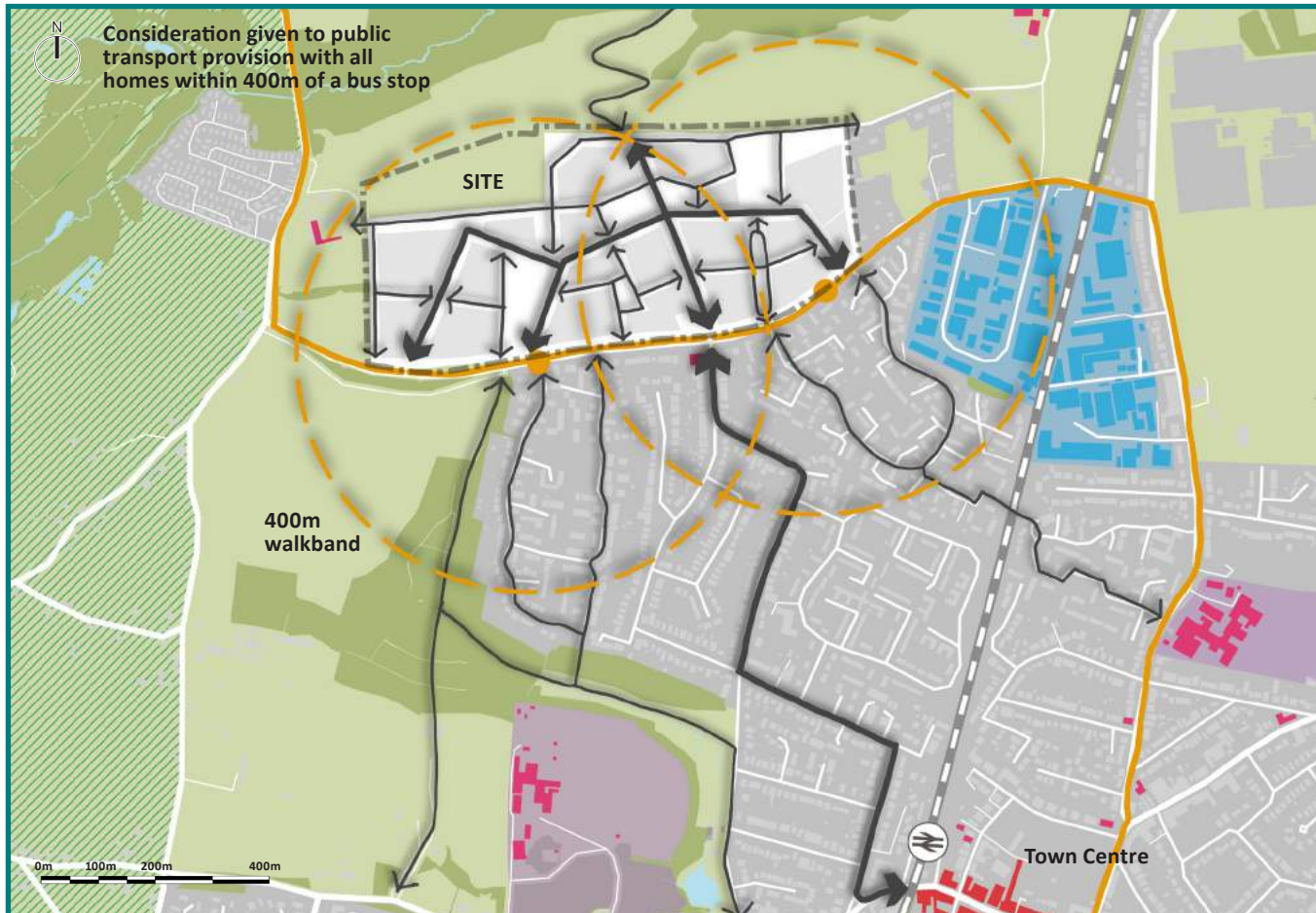

Figure 4.5: INDICATIVE SITE CONCEPT PLAN 5 - Accommodating public transport within the proposal

### Reason

4.2.3 Developments should encourage sustainable lifestyles, minimise reliance on the car and provide choice to residents. This can have many benefits including improvements in health and well-being and to air quality. It needs to be planned early in the design process to provide space for alternative modes and to ensure that carriageway widths are sufficient.

4.2.4 Applicants should consider the needs of the most vulnerable road users first in accordance with the recommendations in Manual for Streets and Manual for Streets 2.

4.2.5 Development will need to adhere to the Highways Development Management Guidance and to CIHT Guidance on Buses in Urban Developments.

### Principle DES15: Reduce reliance on the private car

Applicants should plan and lay out their development to minimise reliance on the private car. They should create a network of safe and convenient pedestrian and cycle routes that are, where appropriate, overlooked and lit to make them attractive to use, both during the day and after dark, and that are integrated with the development and connect with the wider area and adjacent sites.

Public transport should also be accommodated where appropriate.

For larger developments (over 300 homes) applicants should consider at the outset how buses can be routed through a site and the provision of stops in the most accessible locations where they may serve both new and existing residents. This will inform consideration of street design at the more detailed design stage. Whenever possible new homes should be located within 400 metre (approximately 5 minutes walk) of a bus stop and with the distance between bus stops normally 200 - 400 metres.

Priority	User
Consider first ↓	Pedestrians
	Cyclists
	Public transport users
	Specialist service vehicles
Consider last	Other motor traffic

Figure 4.6: User hierarchy from Manual for Streets

## 4. Establishing the structure

### Movement network

VALP Policy Refs: S1; T1; T7



Figure 4.7: INDICATIVE SITE CONCEPT PLAN 6 - Scheme is laid out to allow for further development phases in the future

#### Principle DES16: Anticipate future development

The movement network / layout should be future proofed by providing streets that later phases of development can connect into at the edges of development sites.

This is typically achieved by a combination of:

- Legible links through the site; and
- Perimeter block layouts that generate roads around the perimeter of the site and building frontages that face the boundaries.

#### Reason

4.2.6 Much of the development built during the latter part of the 20th century is laid out as a network of culs de sac accessed off a distributor route and offering little potential for further expansion / extension at a later date. This reduces the potential to deliver well-connected sustainable development patterns and should be avoided.

4.2.7 Proposals should promote connections that extend to the edge of their land ownership allowing the potential for future development to be delivered in the longer term. These should be adopted as public highway to avoid creating future 'ransom strips'.

## 4.3 Existing townscape and heritage

### Principle DES17: Respond to the existing townscape, heritage assets, historic landscapes and archaeology

Heritage assets should be celebrated, conserved and enhanced. Assets should be positively integrated into development to reinforce the existing sense of place and strong local identity and distinctiveness. Central to this process is understanding the significance of the asset(s) and using that understanding to guide development proposals and make informed design decisions.

Development should be responsive to and respect historic characteristics and assets on, and adjacent to, the site. An innovative and responsive approach to design is encouraged, creating an individual identity that complements or forms an attractive contrast with its surroundings. Quality of design and construction, based on an understanding of site development, local characteristics and context, is key to ensure compatible design rather than a particular style or approach.

New development should respond to the physical context, including the pattern, scale and massing of existing settlements and the routes through and around it. In larger scale developments there may be opportunity to create a new character that responds to the existing historic context. Important views should be respected, and new views created to add variety and texture to the setting and aid in embedding the proposed development in the surrounding context.

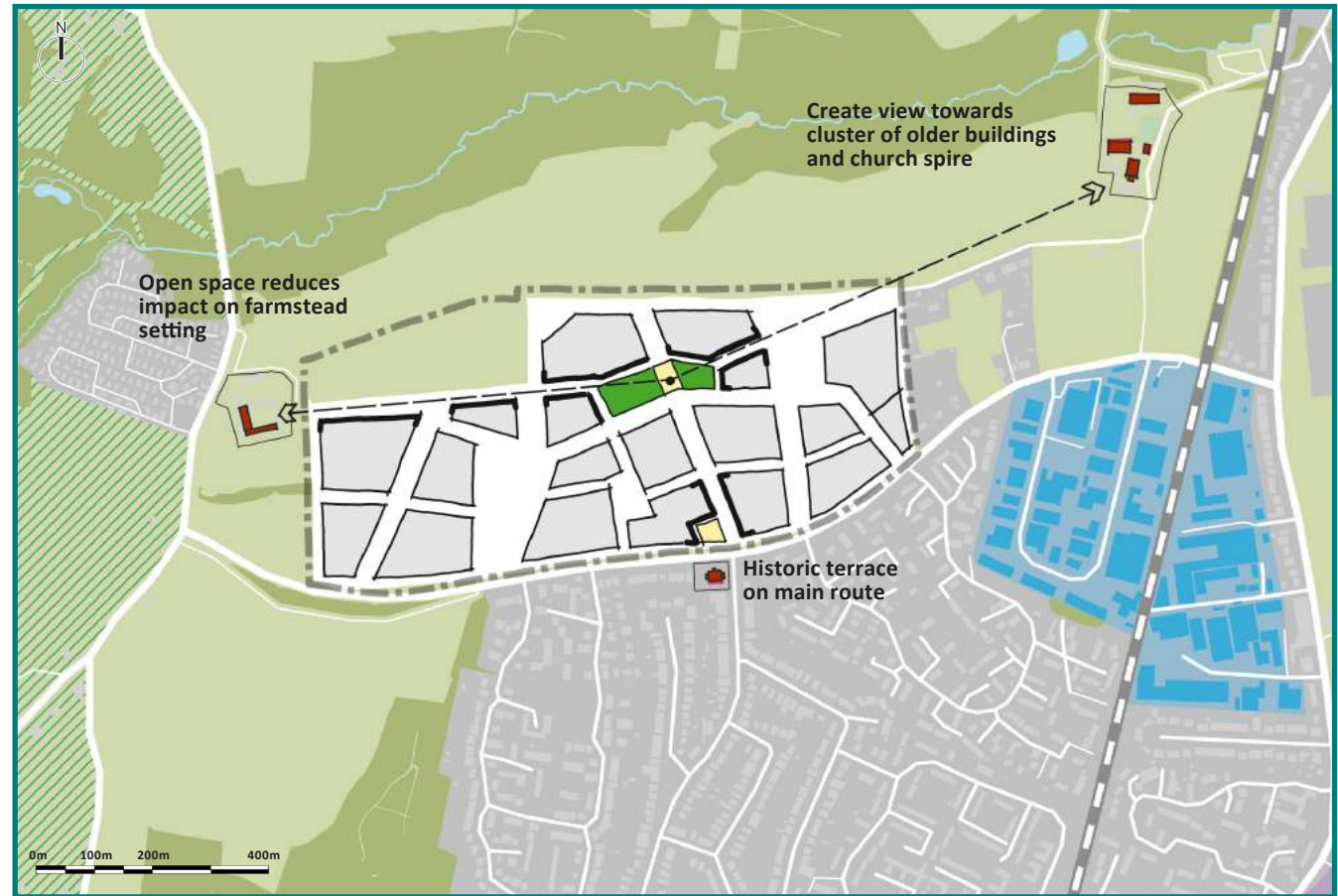

Figure 4.8: INDICATIVE SITE CONCEPT PLAN 7 - Scheme responding to existing townscape and heritage



### Reason

4.3.1 Research published by Historic England on behalf of the Historic Environment Forum (Heritage Counts), highlights the value of heritage as a source of identity, character, distinctiveness and sense of place. Heritage assets play an important part in peoples' perception and experience of place. Retained and enhanced heritage assets incorporated into developments conserve local identity and local distinctiveness.

4.3.2 Within Aylesbury Vale there is a wide variety of settlement types and contexts which is set out in Section 3.5 of this Design SPD. As highlighted in Chapter 3, local detailing and materials are an important part of identity. Commonly found within the Vale are red brick buildings with clay or slate roofs, as well as thatch, limestone or witchert walls, and occasional flint or rubble stone panels.

4.3.3 However, character is not driven by materials alone, and is a combination of interlinked elements. The combination of all elements: form, scale, massing, orientation, layout, roof form and detailing are important in providing character. New developments should respond to their historic character and setting, reinforcing it to create a sense of place which is appropriate to the context. It is expected that materials and building methods used in new development will be high quality, fit for purpose, and designed to weather and age appropriately.

4.3.4 Well-designed public art and interpretation panels are an effective way of communicating history and telling the story of place and should be appropriately integrated into the public realm.

### Understanding significance to create better places

4.3.5 As part of the site appraisal (Principle DES8), applicants should have identified the heritage assets and historic character of the site and its surroundings. The character study (Principle DES7) should analyse the historical development of the site and identify the features that make the site locally distinctive. The next step is to make an assessment of significance of the heritage asset(s) involved.

### Definition of significance (NPPF)

4.3.6 The concept of significance is central to the historic environment sections of the National Planning Policy Framework (NPPF), where it is defined as, "the value of a heritage asset to this and future generations because of its heritage interest". Refer to the Glossary on page 71 of the NPPF for the full definition. Value can take many forms, and a place or asset might tell us about the lives of people of the past, or be a fine example of artistic endeavour, or evoke an emotional response because of a connection with an event or person. Find out more about heritage values in Conservation Principles (Historic England 2008).

### Why we assess significance

4.3.7 The purpose of protection and conservation measures for heritage assets is to sustain their significance. Understanding significance early in the process enables designers to respond positively to heritage assets and their settings, establishing a firm structure and enhancing the sense of place.

4.3.8 Documenting this understanding provides certainty for all those involved in the decision-making process, resulting in better quality and timely decisions. An assessment of significance is a statutory requirement for any application affecting heritage assets or their settings (NPPF para. 194).

### How to assess significance, what the report should contain

4.3.9 A statement of heritage significance should set out what is important about the asset, and why. It should take an impartial standpoint, rather than trying to justify proposals – this being the reason why it should be carried out before development proposals are formed. It also allows the assessor to identify the sensitivity of the asset, helping understand where change can be accommodated without adversely affecting special interest and also identifying where there is potential for enhancement of significance.

4.3.10 The assessment should be carried out by a suitably-qualified professional, or group of professionals in the case of a complex or multi-asset site.

4.3.11 Detailed advice about the content and process of carrying out an assessment of heritage significance is contained in Historic England 2019, Statements of Heritage Significance: Analysing Significance in Heritage Assets, Historic England Advice Note 12 - known as HEAN12 and Historic England 2015, Managing Significance in Decision-Taking in the Historic Environment: Historic Environment Good Practice Advice in Planning 2.

## Relationship of Heritage Statements, Design and Access Statements and Impact Assessment

4.3.12 The statement of heritage significance can strongly support a Design and Access Statement, where one is required, as they both help to show how the applicant has appraised the context of the development and used this information in forming their design.

4.3.13 Design and response to context should be an iterative process; as designs develop, their impact can be checked against the baseline information established early on, and the design influenced further by this consideration.

4.3.14 A heritage impact assessment, based on the assessment of significance, will form part of the later stages of design development and submission of an application. There should be a hierarchy shown through the impact assessment, with adverse impacts avoided or minimised first, and only then mitigation measures provided for any remaining, unavoidable impacts. "Assessing significance before a proposal is planned can lead to better outcomes for the applicant by influencing the design by mitigating harmful impacts on significance, enhancing significance where possible, and thereby showing how any remaining harm is justified" (HEAN 12, para.7, page 4).

### Case study: Alconbury Weald, Huntingdon



A large part of the Alconbury Weald development is located on the former RAF Alconbury airfield which was occupied from 1938 to 1995. The historic fabric of the site remains in the form of five designated heritage assets including hangars, a 13th Century manor house, control centres, bunkers and huts, reflecting a complex and fascinating history. The site also includes areas of historic farmland and a scheduled ancient monument in Prestley Wood.

The former airfield, with eleven miles of perimeter fencing currently sits within the surrounding area but is not part of it.

The development of Alconbury Weald provides an opportunity to reintegrate this land into the surrounding environment.

The proposed development weaves the historic significance of the site, and details, alignments, structures and historical events into the fabric of the development, in turn integrating the development into the historic environment around it. The approach is to:

- Retain, conserve, re-use and interpret the site's designated heritage assets;
- Propose green settings for the listed assets;
- Preserve and archive artefacts, records and drawings related to the site's buildings and use; and
- Develop community history and archaeology projects which will create public involvement in the protection of the site's heritage significance.

The main developer created a place making strategy and Design Code which provided a framework for development across the site, seeking to establish a real sense of place in this mixed-use neighbourhood.

### References

- Historic England 2008, Conservation Principles, Policies and Guidance
- Historic England 2019, Statements of Heritage Significance: Analysing Significance in Heritage Assets, Historic England Advice Note 12
- Historic England 2015, Managing Significance in Decision-Taking in the Historic Environment: Historic Environment Good Practice Advice in Planning 2

### Heritage designations

#### Listed buildings

4.3.15 There are over 3,000 listed buildings in the Vale. The protection afforded by listing applies to the whole building and includes the interior and any curtilage structure within the grounds. Advice on determining whether a curtilage structure is listed can be found in Historic England's Listed buildings and curtilage advice note.

4.3.16 A listed building must not be demolished, altered, converted or extended in any way that would affect its character as being of special architectural or historic interest, without first obtaining listed building consent from the Local Planning Authority. Repairs, such as those which are not like-for-like or those involving the replacement of structural elements or historic fabric, often need consent and so applicants are encouraged to seek advice from the council's heritage specialists. In addition to listed building consent, planning permission and building regulations may be required.

4.3.17 Once a listed building consent application has been submitted, the Council will advertise the proposal and will require consultation with local amenity societies and parish councils for their views on the proposal. On minor works to listed buildings, the Council makes a decision when it has considered representations, and the process is normally completed within eight weeks. Applications for works to Grade I and Grade II\* listed buildings as well as demolitions for all grades will also require consultation with various national bodies so will take longer to determine.

#### Deterioration of listed buildings

4.3.18 Listed buildings may, for a variety of reasons, fall into disrepair. Under such circumstances the Council has special powers. The Council can serve either a Repairs Notice or an Urgent Works Notice. Either Notice served on the owner specifies the works which are considered necessary to protect the building. Historic England maintain a Heritage at Risk Register.

#### Setting of listed buildings

4.3.19 The Planning (Listed Buildings and Conservation Areas) Act 1990 requires Local Authorities to have special regard to preserving the setting of listed buildings. The setting can include development at some distance, especially if the listed building forms a visually important element in the street scene or countryside. Development which affects the setting of a listed building requires careful appraisal. Advice on setting issues and how to assess changes to setting can be found in the Historic England publication 'The setting of heritage assets'. The setting of a Listed Building may contribute to its significance'

#### Guidance on submitting applications for listed building consent

4.3.20 Any applications that affect a Listed Building or conservation area will require a location plan, all floor plans existing and proposed, any external and internal elevations affected by the works and cross sections through the floor, roof, walls, windows, doors and ground level, where these are affected by the works. A Design and Access Statement should also be submitted, as well as photographs, perspectives or photomontages, models or computer visualisations, landscape works and phasing.

4.3.21 Refer to council guidance on validation requirements. A Heritage Statement will also be required as part of the application. In addition, there needs to be an indication that the implications of compliance with the relevant building regulations have been considered and accommodated in any scheme. The Conservation Management Plan provides best practice for converting listed buildings. National best practice, high level guidance and guidance for repairs is available from Historic England and Society for the Protection of Ancient Buildings (SPAB).

## 4. Establishing the structure

### Conservation areas

4.3.22 There are 83 conservation areas in the Vale. Development within or adjacent to a conservation area must respect the special character of the area. Designs for proposals including extensions, windows and doors, boundary features, garages and parking, building materials, satellite dishes, renewable energy technologies, shopfronts, and advertisements will need to follow design guidance for conservation areas.

4.3.23 Further guidance can be found in AVDC Conservation Area Character Appraisals and the AVDC Conservation Management Plan. The Conservation Management Plan provides best practice for development within conservation areas. National best practice, high level guidance and guidance for repairs is available from Historic England and Society for the Protection of Ancient Buildings (SPAB).

### Scheduled monuments

4.3.24 There are 61 scheduled monuments in the Vale. Scheduled monuments are designated for their national importance under the Ancient Monuments and Archaeological Areas Act 1979. Any works affecting a scheduled monument require scheduled monument consent (SMC) and their setting and special interest must be taken into account in any planning application affecting them. Further information can be found on the Historic England website.

### Registered Parks and Gardens

4.3.25 There are 9 Registered Parks and Gardens in the Vale. The Register of Parks and Gardens of Special Historic Interest, established in 1983, identifies landscapes of national interest and their designation gives them equal policy status with listed buildings and scheduled monuments. Their setting and special interest must be taken into account in any planning application affecting them. Further information can be found on the Historic England website.

### Non-designated heritage assets

4.3.26 There are many other older buildings and areas which display a special character within Aylesbury Vale which do not reach the standards required for listing or designation on a national scale, but nevertheless have local interest and value. These non-designated heritage assets are recognised in National Planning Policy and deserve the care and respect that other heritage assets demand. Contact should be made with council heritage officers in order to determine if a building is a non-designated heritage asset. Further information on non-designated heritage assets is available on the council website.

## Townscape and heritage

VALP Policy Refs: BE1; BE2



# 4. Establishing the structure

## How to use

This table provides a checklist for use by both the applicant and planning officer to check that appropriate consideration has been given to how an application has established the structure of the proposal.

**PROCESS:** Have you read, understood and applied the principles set out through Chapter 4?

Have these principles been considered in conjunction with the Planning Designations, Character Study and Site Appraisal prepared in Response to the Site and Setting in Chapter 3?

The adjacent table summarises the key principles set out within this section and can be used by applicants and officers as a checklist.

**Applicants will be expected to demonstrate to the council that they have responding adequately to all relevant principles in preparing their proposals, or provide a justification for any failure to do so.**

Principle	Description	Check
<b>DES9: Natural resources</b>	Has the design proposal used the physical characteristics of the site identified in Chapter 3 to influence the form and layout of new development?	
<b>DES10: Topography and strategic views</b>	Does the design work with the topography and integrate the buildings within the landscape?	
<b>DES11: Green infrastructure network</b>	Has the proposal responded to the site resources and indicated how these inform a landscape strategy?	
<b>DES12: Water features and SuDS</b>	Where applicable has the design sought to retain, enhance and/or re-establish surface water features identified in Section 3 as positive features?	
	Has the design incorporated the use of sustainable drainage as an integral part of the layout and landscape structure?	
<b>DES13: Ecology and biodiversity</b>	Have landscape features with high biodiversity value identified in Chapter3 been retained and incorporated within the proposals? Has the mitigation hierarchy been followed?	
	Do the proposals deliver measurable net biodiversity gain?	
	Have new habitats been created or established, or existing habitats been enhanced or restored?	
<b>DES14: Connect with the existing</b>	Does the proposal integrate with existing routes and access points, and create direct and attractive connections through the site for pedestrians, cyclists and vehicular modes?	
	Does the movement network respond to topography and landscape features, and integrate new and existing public rights of way?	
<b>DES15: Reduce the reliance on the car</b>	Does the proposal prioritise the needs of the most vulnerable road users first creating an attractive network of safe and convenient pedestrian and cycle routes?	
	Does the proposal incorporate space for public transport where appropriate?	
<b>DES16: Anticipate future development</b>	Is the design future proofed by providing streets that later phases of development can connect into at the edge?	
<b>DES17: Heritage assets and the historic landscape / archaeology</b>	Does the design respond to, celebrate, enhance or preserve any heritage assets and historic landscapes within, or adjacent to, the proposals?	



# 5

## Site layout, streets and spaces

Well designed streets and public spaces that are accessible to everyone contribute significantly to the success of places. These should be laid out to be comfortable, stimulating and attractive environments that encourage social interaction, act as meeting points for communities, add value to surrounding properties and generally add to the character of a neighbourhood.

The design of the public realm (the streets and spaces around buildings) is as important as the design of buildings. All too often in new development these elements are given less design consideration or dictated by standardised, engineered solutions.

The guidance in this chapter will help applicants to develop the structure of their development into a more detailed layout. It emphasises the importance of the public realm as well as the design of social spaces that contribute to the success of an area.



# 5. Site layout, streets and spaces

## Inclusive sustainable design

VALP Policy Refs: NE6; I1; I2; I4; I5

### 5.1 Inclusive and sustainable design

#### Principle DES18: Design for everyone and look to the future

The future-proofing of a design is integral to the implementation and long-term success of any development. Applicants therefore need to take the changing climate, and the conditions it will bring with it, into account. This could be through, the selection of plant species for an environment two degrees warmer in the Vale, providing shade or through pest and disease resilient cultivars. See Principle DES47: Minimise environmental impact through energy efficient and sustainable design.

Proposals should install infrastructure that looks to the future including electric charging points for cars (refer to Principle DES27) and consider new ways of doing things for instance introducing car club spaces.

Design should be compliant with the Disability Discrimination Act 1995 and Equality Act 2010, or any subsequent legislation, therefore enabling

everyone to use the space and participate in community activities equally, irrespective of their age, gender, ethnicity, religion and mobility and thereby meet the needs of people using wheelchairs, those with mobility impairments or with pushchairs.

Spaces should be designed to encourage social interactions which cross demographic groupings and should not be intended for one particular group.

Development should be designed to allow safe and easy use by all, to limit both physical and perceived barriers which will allow for independent use. This can be achieved through appropriate choices in street furniture and careful design of paving, parking, public transport provisions, lighting and signage.

#### Reason

5.1.1 Buildings and public spaces should be designed so that they are accessible and inclusive to all users.

5.1.2 An inclusive approach to design enables everyone to participate equally, confidently and independently in everyday activities. The principles of inclusive design, identified by the Design Council CABI, should inform development proposals.

5.1.3 The five principles are:

- Place people at the heart of the design process;
- Acknowledge diversity and difference;
- Offer choice where a single design solution cannot accommodate all users;
- Provide for flexibility in use; and
- Provide buildings and environments that are convenient and enjoyable to use for everyone.



Create environments that are accessible to everyone



Access to property is made difficult by poor response to site levels

5.1.4 When designing streets and spaces applicants should follow the healthy streets approach which focuses on the human experience and embeds public health in the design process (refer to Principle DES26).



### 5.2 Urban structure and sense of place

#### Principle DES19: Deliver a clear structure of streets and spaces that is easy to understand and move through

Applicants should promote an urban structure to their development that is easy to understand, where there is a clear street hierarchy and network of open spaces and that is reflective of settlement characteristics and form.

Development should create a grid network of streets and perimeter blocks which may be regular or irregular in form. The perimeter block is most appropriate for achieving successful development as it:

- Optimises connections to surrounding areas;
- Provides a clear distinction between public and private spaces;
- Enhances permeability and legibility;
- Generates building frontages that face the street and thereby increases natural surveillance and activity on the street;
- Creates secure and private rear gardens and elevations;
- Can work at any scale or location; and
- Ensures attractive street frontages.

The block size and shape will vary according to the density of development, location within the Vale and mix of uses. The blocks should take into account natural features, orientation and topography.



Figure 5.1: INDICATIVE SITE CONCEPT PLAN 8 - Delivering a clear structure of streets and spaces

#### Reason

5.2.1 The layout of all existing towns and cities can be simplified into a grid of blocks and plots. The blocks within the grid may be regular shaped squares or rectangles (providing a regular grid), as found in many new towns, or it may be more irregular (providing a more irregular grid), as found in historic towns and villages.

5.2.2 Blocks will vary in size and shape and should be broadly reflective of the sites settlement context whilst respecting natural features, orientation and topography, and providing sufficient back to back distances to provide residential amenity.

5.2.3 In general, blocks between 50 - 120 metres in length provide a permeable network for both pedestrians and vehicles.

# 5. Site layout, streets and spaces

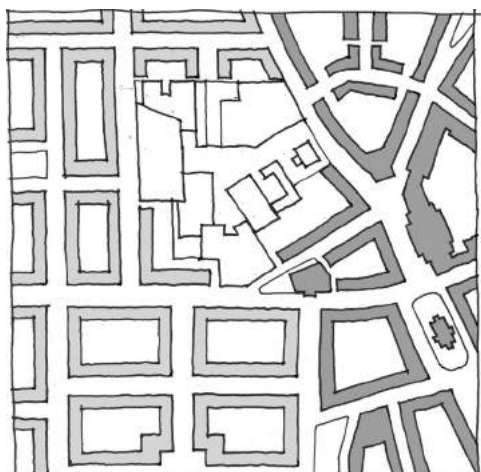

Figure 5.2: Regular gridded street pattern (west) and historic pattern (east)

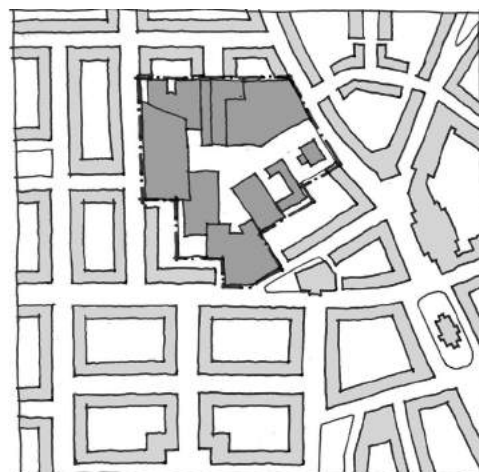

Figure 5.3: Development site of former industrial buildings identified for change

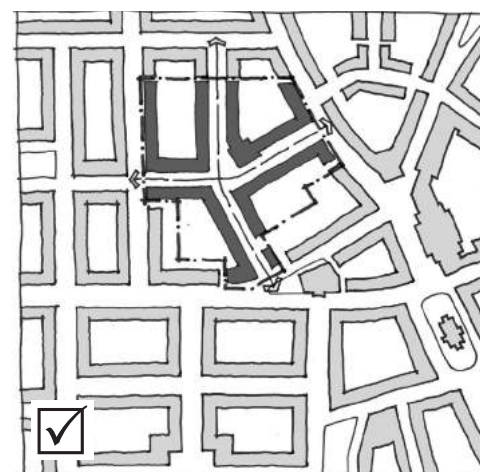

Figure 5.4: Development proposes a connected network of streets with blocks contributing to the existing pattern

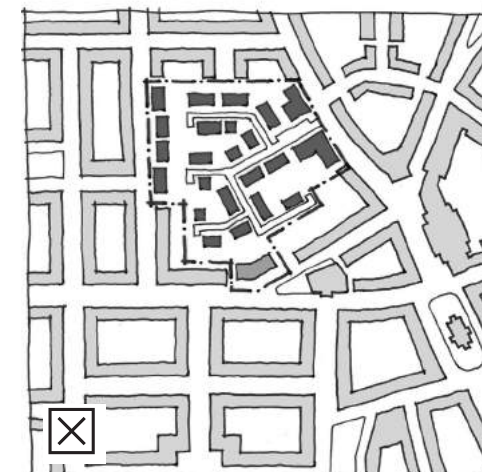

Figure 5.5: Development proposal is internalised and fails to provide pedestrian permeability with new buildings accessed via cul-de sac streets

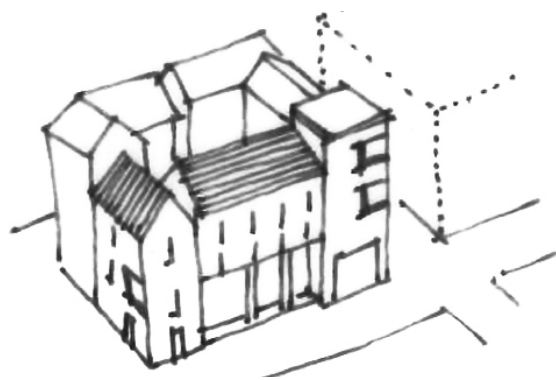

Figure 5.6: Higher density, urban blocks are suitable in more urban locations

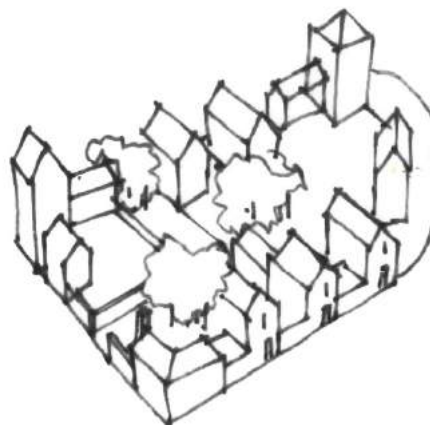

Figure 5.7: Lower density, blocks are more suitable in rural locations



Properties expose their rear boundaries to the street providing no animation or overlooking of the streetspace and contrary to secured by design principles

## 5. Site layout, streets and spaces

### Principle DES20: Provide enclosure and positive frontage to streets

New development should normally provide strong street enclosure and continuous frontages that provide coherent building lines with the corners of blocks emphasised. Buildings should be arranged with public areas to the front and private areas to the rear and so that buildings overlook and provide active frontages and natural surveillance to streets and spaces.

Proposals should provide a sense of enclosure appropriate to the role of the street within the street hierarchy and in order to achieve a human scale. This will help to create a sense of place and reinforce the legibility of the development.

Streets and spaces that do not provide adequate enclosure or are dominated by roads or parking will not be acceptable.

### Reason

5.2.4 The siting of buildings in relation to the street can have a significant effect on the success of a development. The most successful layouts have 'public fronts and private backs'. These streets have clearly defined 'edges' and allow for natural surveillance minimising opportunities for crime and escape. It also encourages greater social interaction between neighbours.

5.2.5 Within established urban areas where there is an existing building line, this should inform the design and layout of a new development with new buildings following the established line.

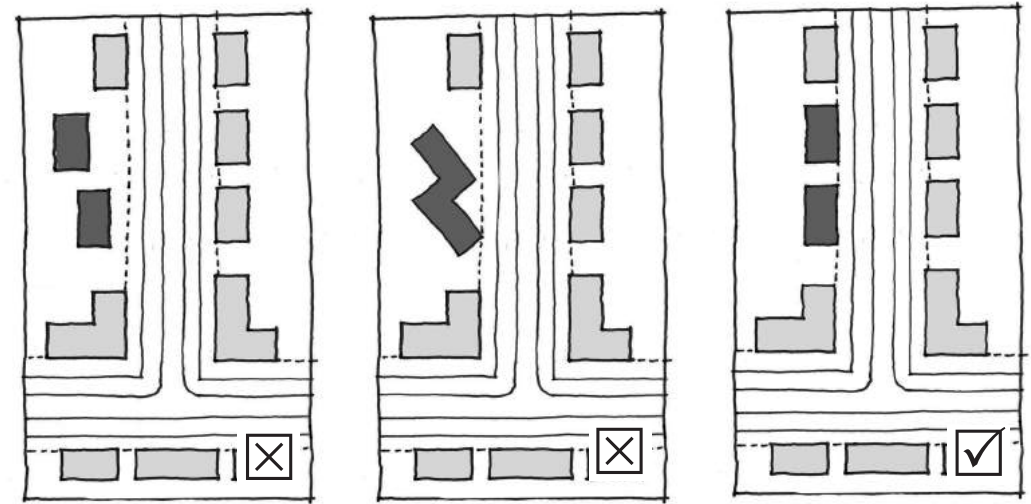

Figure 5.8: New buildings in a street should follow the established building line

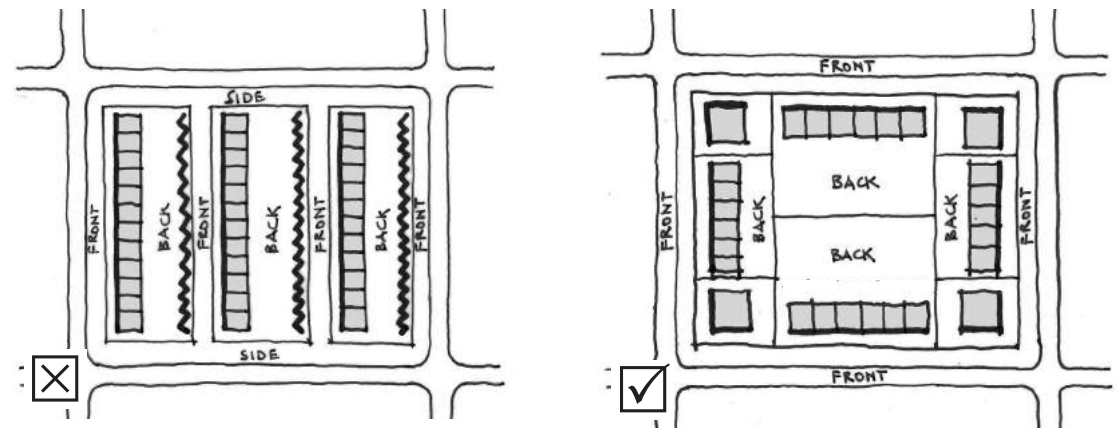

Figure 5.10: Streets should not mix fronts and backs

Figure 5.9: Perimeter block layout ensuring a clear definition of front and backs and a strong building line to the street

## 5. Site layout, streets and spaces

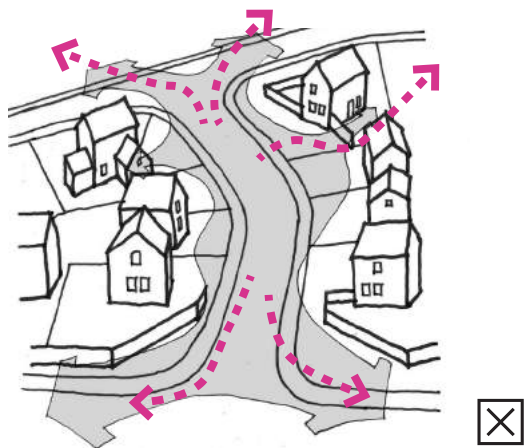

Figure 5.11: Road dominated: lack of enclosure

5.2.6 The distance that the building line is set back from the street, together with the height of the buildings determines the level of enclosure that is experienced within the street.

5.2.7 Enclosure may be building dominated or landscape dominated. Trees, hedges and walls can contribute towards creating a sense of enclosure.

5.2.8 Enclosure also creates different conditions. In the case of a square or courtyard, enclosure helps to create a 'static' environment; in a street, where movement is the main characteristic, enclosure helps to create a 'dynamic' environment.

5.2.9 Enclosure is normally calculated by the ratio of the height of the buildings to the width of the street or space.

5.2.10 It is usually appropriate to set buildings back from the public realm to provide a private defensible space. Even the smallest setback can help privacy and security.

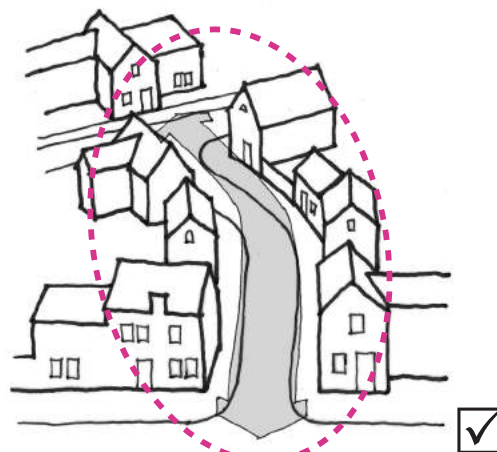

Figure 5.12: Place focused: enclosure provided by buildings creates a better street environment

5.2.11 The setback distance should normally be between one and three metres with applicants balancing the need for enclosure, site optimisation and privacy. However where larger front gardens are a strong characteristic of an area a greater set back distance may also be appropriate.

5.2.12 Applicants should refer to their Character Study (Chapter 3) to inform the level of enclosure appropriate for their site. As a rough guideline, a ratio of between 1:1.5 to 1:3 (height:width) is likely to be appropriate depending on the hierarchy of street or public space (Refer to Urban Design Compendium). Applicants must seek to maintain or enhance the characteristics of the context within which their site is proposed. The space between buildings should be well defined but not oppressive.

5.2.13 A significant challenge for larger residential developments is to provide a form of development that is appropriate to people rather than cars.

## Urban structure

VALP Policy Ref: BE2



Buildings define the back of footway at the former Princess Mary's hospital, Wendover



Buildings create a strong sense of enclosure at the Princess Mary's hospital, Wendover

5.2.14 When buildings are set back from the street, road space and parking areas should not dominate the street scene.

5.2.15 Human-scaled streets can normally be achieved through increased levels of enclosure (typical of historic developments that pre-date the motor car) by setting buildings close to the street edge (responding to pedestrian rather than car movements).

5.2.16 Creating a sense of enclosure on a main street through a development may require an increase in building height to balance the increased building to building distance.

# 5. Site layout, streets and spaces

## Mix of uses

VALP Policy Refs: D6; D7; BE2; T1; T6; T8

### 5.3 Mix of uses

#### Principle DES21: Promote a mix of uses within larger schemes to provide services to meet local needs, conveniently located where they are most accessible

Larger scale development proposals will normally require a range of local services and facilities to be incorporated. The viability and vitality of these uses will depend on the existing and proposed catchment.

The location of mixed-use centres and neighbourhood hubs is key to their viability and long-term success.

Mixed-use centres should:

- Be conveniently located at the intersection of well-connected streets;
- Be highly visible;
- Cluster a mix of facilities around an appropriately scaled high quality public realm or public space as a central focus with buildings serving to enclose the space;
- Provide higher floor to ceiling heights at ground floor level to accommodate a variety of uses and allow for future adaption;
- Include residential development within the mix above non-residential uses to ensure activity and surveillance throughout the day and night;

- Wrap and conceal the non-active parts of larger non-residential buildings (such as supermarkets or leisure buildings) within blocks with a perimeter of active development;
- Locate servicing areas where they do not visually dominate the streetscene and avoid dead frontage overlooking the public realm;
- Be accessible for all users, with particular consideration given to how the elderly and disabled will access and use the centre;
- Provide short stay / visitor and disabled car parking spaces and secure cycle parking integrated into the streetscape or landscape design with convenient access to capitalise on passing trade. The appropriate number, location and layout will depend on the local context. Electric vehicle charging points should also be provided where appropriate; and
- Be accessible by pedestrian and cycle users and be served by a frequent bus route with bus stops conveniently located and well-overlooked and where they are accessible to everyone and attractive to use to encourage patronage.

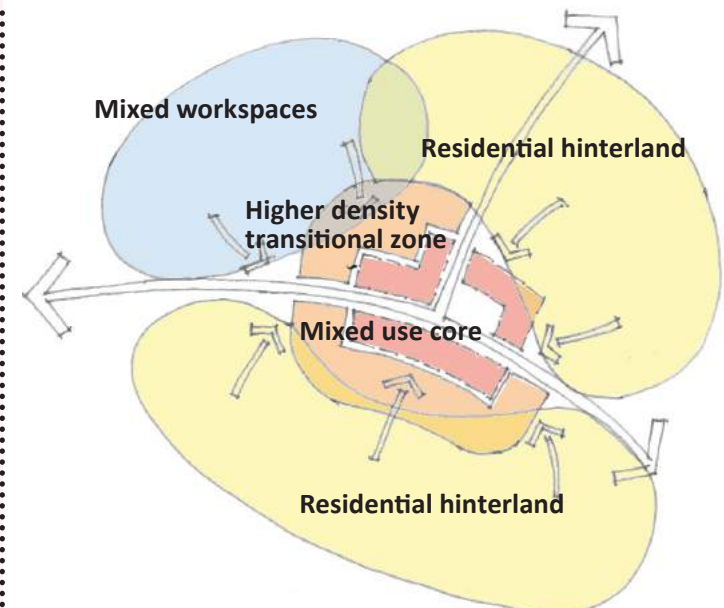

Figure 5.13: Mixed uses should be promoted in the most accessible locations

#### Reason

5.3.1 Successful communities require a full range of local facilities and services conveniently located and integrated within a settlement and that are connected by safe and pleasant streets.

5.3.2 A mixed-use development helps to support activity and surveillance throughout the day and night contributing to a greater feeling of safety.

## 5. Site layout, streets and spaces

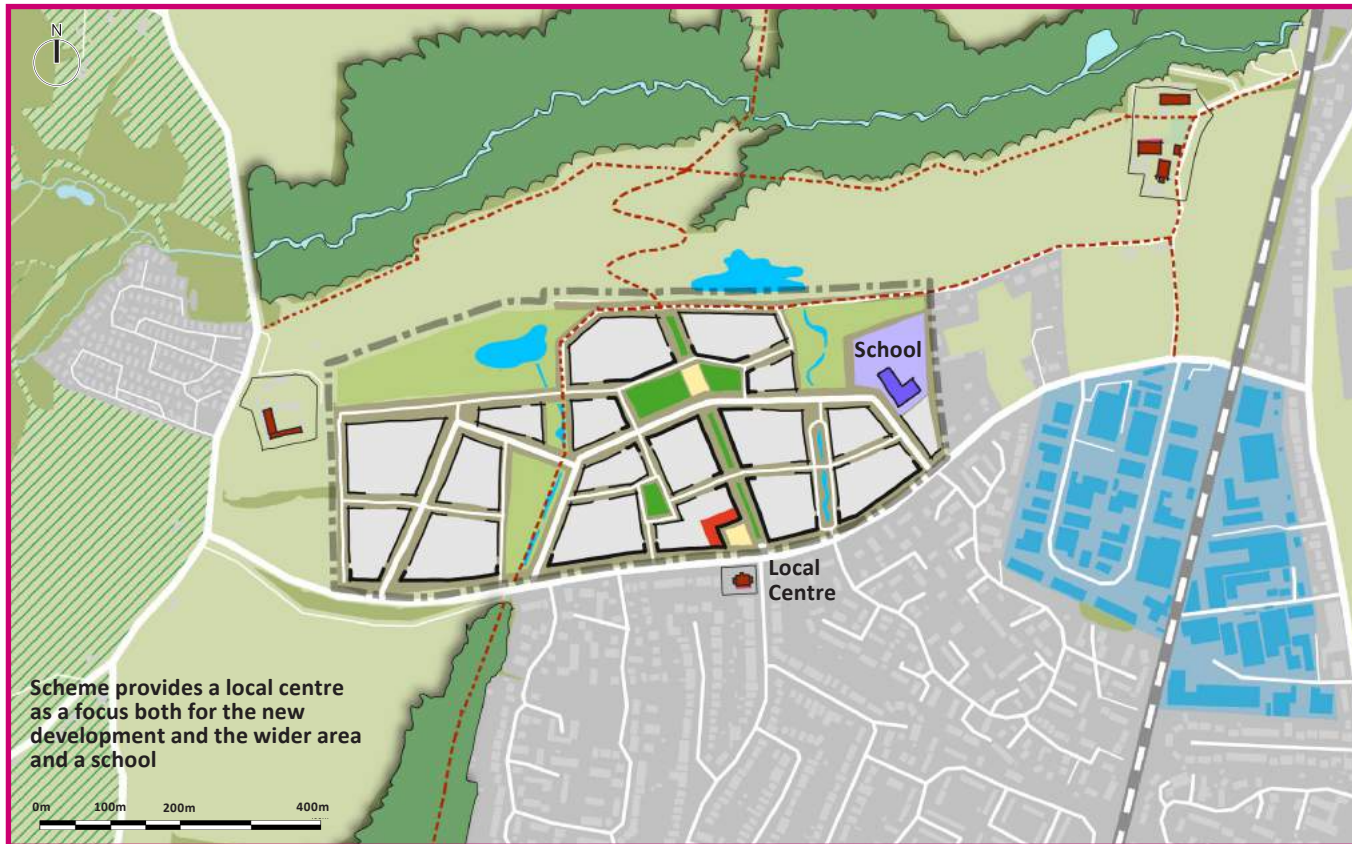

Figure 5.14: INDICATIVE SITE CONCEPT PLAN 9 - Provide a mix of uses

### Mix of uses



The Exchange in Aylesbury town centre provides residential uses over restaurants and overlooks a new high quality public space



Local centre at Fairford Leys, Aylesbury provides local services

## 5. Site layout, streets and spaces

### Principle DES22: Provide a mix of residential typologies within residential schemes to create mixed communities and ensure these are adaptable to change

Applicants should deliver development that provides a mix of dwelling types and tenures to meet local need as identified in Local Plan Policies H1 Affordable housing, H6a: Housing Mix, H6b: Housing for older people, H6c: Accessible and adaptable dwellings and H5; Self / custom build housing. Applicants should agree this mix through discussion with the council.

Affordable housing should be distributed appropriately throughout the site, and have the same external appearance and quality of finishes as private housing. There are nevertheless architectural benefits of grouping identical housing types as it gives street frontages underlying rhythm and order. Grouping housing types also aids diversity across the development.

Buildings should be designed so that they can be altered internally or externally over time without the need for demolition or rebuilding as needs change. Very narrow fronted buildings are unlikely to be easily altered or extended. By building flexible internal space, rooms can be adapted to different uses depending on family requirements.

Buildings should be designed to maximise the potential for lifetime use. Refer to Lifetime homes guidance for further details.

New residential developments should address the needs of people with disabilities by complying with Building Regulations. This requires reasonable provision to be made for people with disabilities to gain access to and to use buildings.

Wheelchair accessible homes should be designed in accordance with recognised guidance such as Wheelchair Housing Design Guide (Habinteg, 2006). These homes should be positioned in highly accessible locations.

For proposals of 100 dwellings and above the council expects applicants to identify a percentage of plots for sale to self-build / custom builders in accordance with VALP Policy H5. These plots must be integrated into the applicants scheme and the council will not accept proposals that allocate these plots to the least favourable parts of a site.

## Mix of uses

VALP Policy Refs: H1; H5; H6a; H6b; H6c



Custom housing can deliver greater variety and choice

### Reason

5.3.3 People have differing requirements of their home, depending on cultural needs, economics, health requirements and age. The housing available should reflect this diversity and allow people to up and downsize as their life changes or to adapt their property to respond to changing needs.

5.3.4 Development that is capable of responding to changing social, technological and economic conditions is more likely to be successful and ultimately more sustainable.

## 5.4 Density, scale and massing

### Principle DES23: Ensure that development density and the scale and massing of proposed buildings responds to the existing and emerging character and context of an area

New development should generally respond to the scale, massing and grain of adjacent areas and the settlement context within which it is located.

In some parts of Aylesbury Vale, notably in Aylesbury Garden Town, but also in other towns in the area, there may be an opportunity to deliver a new development character provided this is part of a comprehensive vision, establishes sense of place and does not impact on the sensitive townscape, heritage assets or landscape assets of an area.

For larger development proposals a range of densities, building types and forms are likely to be appropriate.

Increased densities should be focused:

- Around key movement intersections;
- Along strategic routes;
- Overlooking public spaces; and
- Within town, village and local centres.

This varied density profile adds character and interest, supports local facilities and public transport and can provide the building mass to create strong framing of public spaces.

Within larger new residential urban extensions

building height and scale in the most accessible and central areas may be up to four storeys. This will deliver higher density development, diversify the mix of residential typologies and create a focus for the new development.

Development that is of a greater scale, height and massing than the existing context can have both adverse local impacts in respect of daylighting, overshadowing, views and microclimate and adverse visual impacts from further afield particularly if a proposal is on elevated land.

Any development that promotes a scale, height and massing that is greater than the existing context must therefore demonstrate that:

- It does not cause unacceptable impacts on adjacent properties in respect of daylighting, sunlighting and overlooking; and
- That it does not adversely impact on views of the wider townscape.

Consideration must also be given to the provision of car parking within higher density schemes and applicants will need to promote solutions that do not adversely impact on the quality of the streets and spaces. In some locations basement car parking or car free developments should be considered.

### Reason

5.4.1 The scale and massing of development must be appropriate for the site in which it is promoted.

5.4.2 Whilst higher density developments within town centres is generally welcomed and will help to deliver much needed homes and employment space in the most sustainable places, consideration must be given to:

#### The scale of buildings

- This should normally relate to the immediate and wider context.

#### The uses at ground floor level

- On the main commercial streets within town centres, uses should generally be non-residential and provide an 'active' frontage that animates the street (shops, café, restaurant, office, community use for instance). Blank frontages will not be acceptable.

#### The interface of buildings with the street

- Where active uses are promoted buildings should front directly onto the public realm with the building positioned to conform with an established building line. Where residential uses are promoted at ground floor level, buildings should be set back from the street and appropriate privacy created through boundary and interface treatments and planting (refer to Principle DES39).

#### The location of car parking

- This should not dominate or adversely impact on the quality of the street environment.



## 5. Site layout, streets and spaces

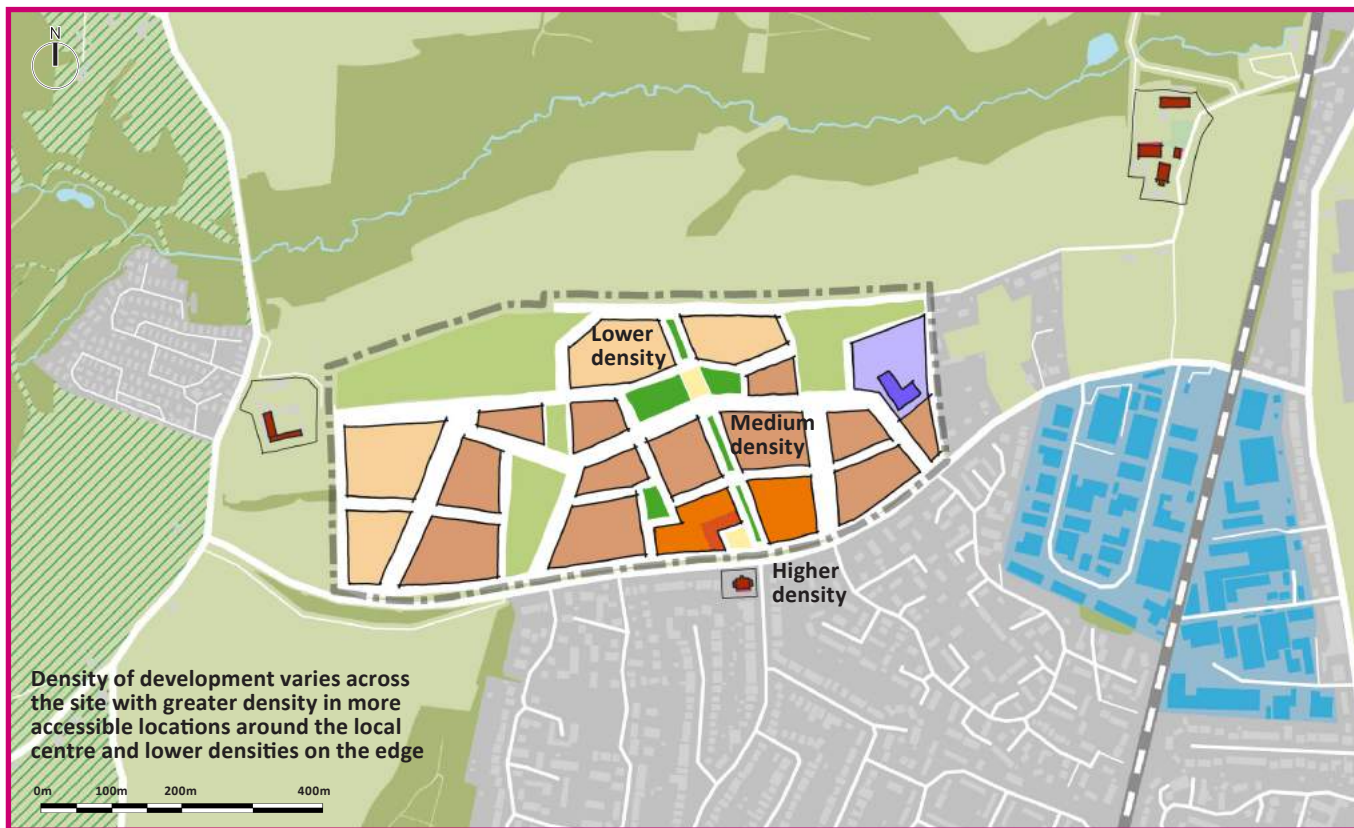

Figure 5.15: INDICATIVE SITE CONCEPT PLAN 10 - Increasing density in relation to accessibility

5.4.3 Within larger urban extensions, including within Aylesbury Garden Town, the character and form of the different parts of the development should vary in order to enhance legibility and sense of place and deliver a variety of residential typologies to create a more balanced community. Refer also to Chapter 7.

5.4.4 This variation of development character across a site will deliver a range of residential densities with higher density development in the more accessible locations and lower density development in the more peripheral areas.

5.4.5 More compact development that creates a stronger sense of street enclosure should be promoted along main streets and around local / neighbourhood centres. This may be delivered through a combination of greater height, vertically articulated frontages and terracing of properties to deliver a more continuous street frontage with underlying rhythm and order. Care must however be given to air quality issues where more compact development prevents air circulating and pollution dispersing effectively.

## Density and scale

VALP Policy Ref: BE4



✓ Compact urban scale of development (at this scale only likely to be appropriate in town centre locations)



✓ Contemporary terrace of homes



✓ Duplex with front door and flats above can be a good way of delivering higher density development

# 5. Site layout, streets and spaces

### 5.5 Legibility and image

#### Principle DES24: Use markers, landmarks, vistas and street hierarchy to aid legibility

Development should seek to enhance legibility through a layout that responds to existing landscape features (including trees), structures or buildings or through the careful location of new features or buildings to act as markers or landmarks. For larger schemes development should be laid out with a clear street hierarchy that allows users to easily distinguish main streets from secondary and minor routes.

#### Reason

5.5.1 Landscape features including trees, structures or special buildings can help to add distinctiveness to a place and act as visual cues to aid legibility and understanding.

5.5.2 Streets that create a varied sequence of spaces and vistas aligned with focal buildings can be more rewarding and contribute to the understanding of a place. This can be achieved through:

- A curve or kink in the street;
- Off-setting the street network and terminating the view on a building;
- Creating a pinch point; and/or
- Locating a taller building to terminate an axial view.

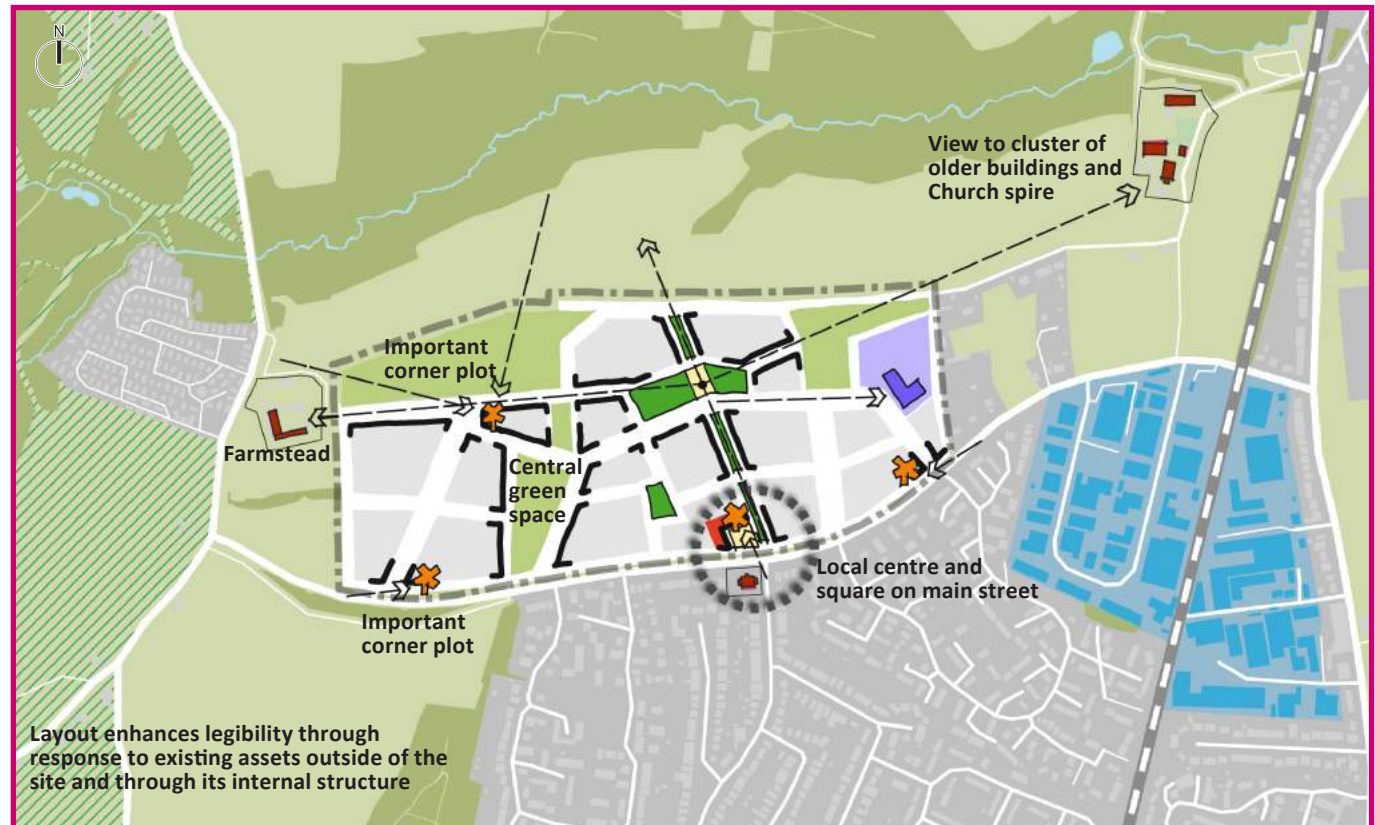
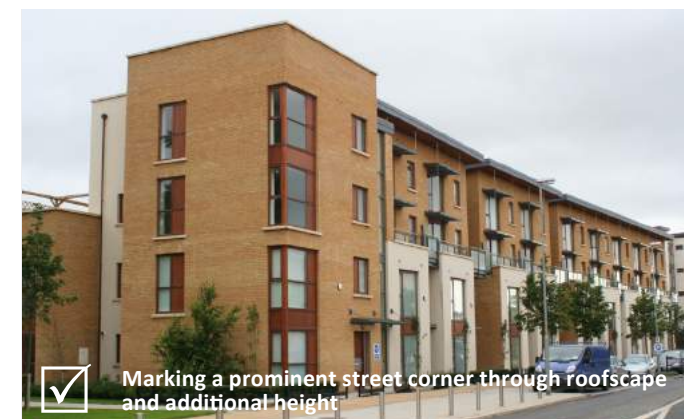

Figure 5.16: INDICATIVE SITE CONCEPT PLAN 11 - Enhancing legibility

5.5.3 Buildings marking an important place or location in the townscape may be a little taller than the surrounding context but this increase in height must be proportionate to the role that they play in the streetscape.



## 5. Site layout, streets and spaces

### Principle DES25: Create a positive development edge

Applicants should normally design their proposals with building frontages facing site boundaries served by new access roads that run adjacent to the site edge for the following reasons:

- To avoid back fences abutting the countryside;
- To fully reveal existing trees and hedgerows to the public realm; and
- To safeguard the future of existing trees / tree belts / hedgerows by incorporating them outside private gardens while also avoiding overshadowing of rear gardens.

Development should be sensitively designed so that it avoids imposing upon the rural edge and existing roads that are characterised by their hedgerows and tree belt. This may require additional boundary planting. At the rural edge lower density development will normally be necessary.

### Reason

5.5.4 The interface between a settlement and the countryside should provide a positive transition between the two environments. On the one hand there is a need for a clear definition of where the settlement starts that provides a welcoming edge and sense of arrival. On the other hand it will often be necessary to use planting to help to soften the impact of new development on the surroundings.



The edges of development should respond positively to the existing landscape and avoid close boarded fences abutting the countryside



Development presents an unacceptable relationship with the wider countryside

5.5.5 Properties should not back onto the settlement edge and the edge should not be defined by rear garden fences. This can create security problems and over time the quality of the environment can become degraded as fences are replaced or fall into disrepair. When viewed from the countryside this creates an unresolved and untidy edge that diminishes the quality of the environment.

## Legibility and image

VALP Policy Ref: BE2



Homes at the former Princess Mary's hospital in Wendover have a positive relationship with the adjacent woodland

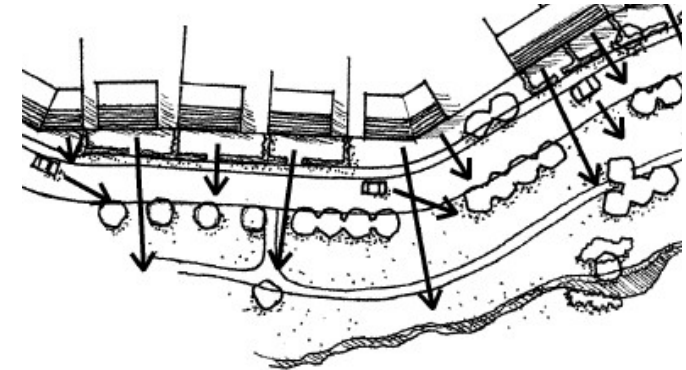

Figure 5.17: Development provides a positive development edge

## 5. Site layout, streets and spaces

### 5.6 Pedestrian friendly streets / street hierarchy

**Principle DES26: Provide attractive streets and spaces defined by buildings rather than the highway, that encourage low speeds and that are safe to use by everyone**

Streets should be designed as social spaces with the needs of pedestrians, cyclists and public transport users put above the needs of the motorist.

Within larger developments a clear street hierarchy should be promoted with the principal vehicular routes integrated within the structure of development as main streets or boulevards with tree lined building frontages.

Streets should be well defined and enclosed by building frontages normally in combination with a line of trees and appropriate planting. Refer also to Principle DES35.

Streets should encourage pedestrian movement through appropriate pavement widths, avoiding unnecessary barriers or clutter and providing places for pedestrians to rest, gather and socialise.

Residential streets should be designed to a maximum speed of 20 miles per hour. Traffic calming measures should be integrated within the design of the streets (and not as engineered solutions imposed afterwards) to encourage drivers to drive with care and caution.

Where traffic generated by the development is likely to give rise to unacceptable impacts on the surrounding streets, spaces and neighbourhoods, the impacts should be identified and on or off site mitigation provided in accordance with VALP policy T5 and the design principles in this SPD.



Streets with generous footways, tree planting and good overlooking from adjacent buildings feel safer to use

#### Reason

5.6.1 Streets should be designed as public spaces that serve many functions, not only the circulation of traffic, but also walking, cycling, play and places for social interaction. Streets should provide shade and shelter, make people feel safe and relaxed, and provide interest and visual stimulus. As such the design of streets should not be led by engineering solutions or dominated by the car but instead have a strong emphasis on place-making and pedestrian movement.

5.6.2 New developments should be designed to encourage sustainable transport modes and healthy lifestyles and to reduce reliance on the car. This can have positive benefits on air quality and human health. To achieve this it is important that the street environment is attractive to pedestrians and cyclists and feels safe.

## Pedestrian friendly streets

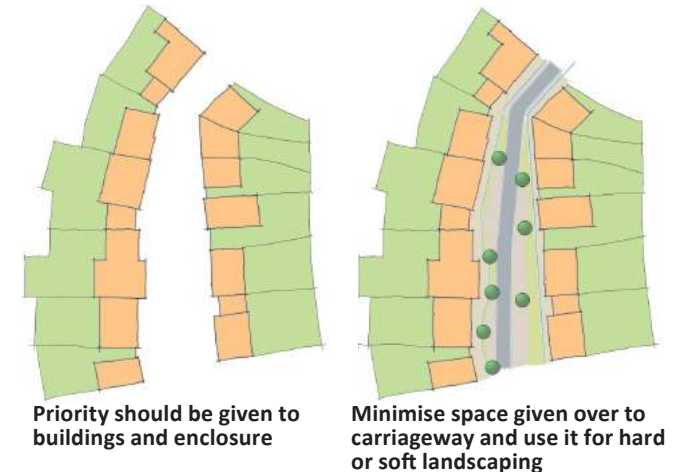

Priority should be given to buildings and enclosure

Minimise space given over to carriageway and use it for hard or soft landscaping

Figure 5.18: Design streets as social spaces

5.6.3 The design of streets should follow the Healthy Streets approach. This uses a number of indicators as measures that improve health, reduce inequalities and encourage people to walk and cycle. The design of streets should:

- Be open to pedestrians from all walks of life;
- Provide infrastructure that is easy to cross;
- Offer shade and shelter;
- Offer places to stop and rest;
- Not be too noisy;
- Encourage people to walk, cycle or take public transport;
- Make people feel safe;
- Offer things to see and do;
- Allow people to feel relaxed; and
- Have clean air.

## 5. Site layout, streets and spaces

### Pedestrian friendly streets

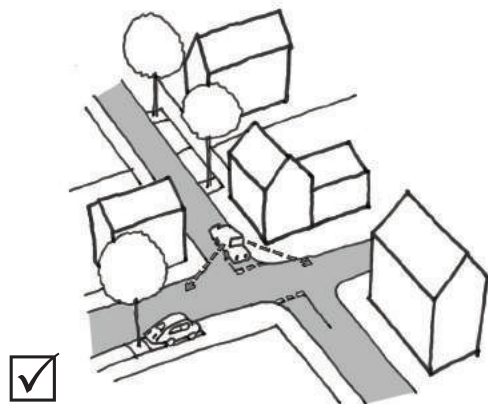

Figure 5.19: Frequent changes in direction, tight junctions and corner radii help to control traffic speeds

5.6.4 Creating roads which naturally reduce traffic speed plays a crucial role in road safety. Traffic calming should form part of the overall street design and should not be achieved through isolated measures like 'speed humps'. Designers should employ good design principles to ensure appropriate traffic speeds. Streets where 'place' functions dominate over 'movement' functions should be designed for a 20 mph speed limit.

5.6.5 Calming measures can help to create a more pedestrian friendly environment and may include:

- Varying the alignment of the vehicular route;
- Use of tight junction radii;
- Narrowing down the carriageway and the use of planting and build outs;
- The provision of on-street parking;
- Raised areas at junctions and nodal points; and
- Changes to surface colour/materials.

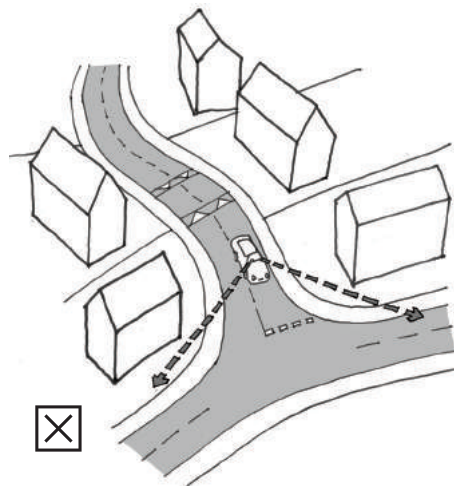

Figure 5.20: 'Fast' road with gentle bends and wide sight lines controlled by speed bumps gives mixed messages and can encourage speed

5.6.6 The use of shared surfaces will not be acceptable on through roads or roads serving more than 25 properties.

5.6.7 Other measures that make a street environment more attractive for pedestrians include:

- Provision of places to stop and rest;
- Areas of shade and shelter;
- Obstruction-free pavement edges to make road crossing easier; and
- Formal crossing points across busier roads, or at high-usage sites such as schools.

5.6.8 Unnecessary road markings, signage and other 'street clutter' should be minimised on streets where 'place' functions dominate over 'movement' functions. This helps to create better places, a better pedestrian environment and encourages safer driving.



Traffic calming measures should be integrated within the design of streets



Successful shared surface street (serving local properties only) incorporating tree planting, soft landscaping and parking



Speed bumps as a traffic calming measure for new roads should be avoided.

### 5.7 Parking

#### Principle DES27: Integrate parking to meet needs and support attractive streets and spaces

The quality of the street environment should be a paramount consideration in designing parking spaces into the street. The inclusion of landscape and street trees as well as the provision for pedestrians should be integral to the design.

Applicants should prepare a comprehensive car parking strategy which contains a combination of appropriate parking solutions with a balance of on-street and off-street parking provided.

To achieve well defined streets with a good level of enclosure and avoid parking dominating streets, it will normally be necessary to accommodate undercroft or underground parking in the higher density areas with terraced housing and flats. Rear courts should generally be avoided and only provided where it is demonstrated that other solutions are not possible. They should be gated.

Larger parking courts/squares will normally be unacceptable unless they are designed as part of a well landscaped and ordered open space that contributes positively to the development.

On-street (right-angle and parallel parking) and front threshold parking will need to be

well landscaped and incorporate generous safeguarding areas around trees and shrubs to protect them from pedestrian as well as vehicular movement, and provide for private defensible space at the front of dwellings.

For lower density areas with detached and semi-detached houses, parking should normally be discreetly accommodated to the side of dwellings. Off-street parking in front of houses should normally be avoided as this is likely to result in environments dominated by hard surfaces and generates greater face to face building distances leading to weaker street enclosure unless combined with taller building frontages.

Right-angle on-street parking is nevertheless sometimes acceptable providing it is positively designed as part of a comprehensive landscaped public realm and is limited to one part of a comprehensive parking strategy for the higher density areas.

Electric charging points should be provided in accordance with VALP policy T7.

#### Reason

5.7.1 Applicants should provide parking for both residents and visitors at an adequate level in response to the location of the site. The number of spaces must be determined using the councils parking standards or local standards where these are different (for example as identified within a Neighbourhood Plan).

5.7.2 The accommodation of parking represents a significant design challenge. If poorly designed parking can have a significant negative impact on the appearance of the public realm.

5.7.3 A balanced approach should be taken to achieve convenient parking in close proximity to households whilst reducing the dominance of parking on the street scene. This will normally result in a range of parking solutions being incorporated. Areas of planting or street trees can help to reduce impacts (refer also to Principle DES35).

5.7.4 Non-allocated, shared parking (generally on street) is more efficient than designating parking to individual dwellings and this approach is encouraged to reduce parking numbers within development schemes especially in respect of terraced housing.

5.7.5 The suitability of parking solutions will vary depending on the location and nature of the proposal.

5.7.6 Parking standards, including the minimum dimensions of parking spaces and garages is set out in VALP Appendix B.

## 5. Site layout, streets and spaces

### Parking

VALP Policy Refs: T5; T7; Appendix B



Figure 5.21: A good formal arrangement for a primary street that incorporates parallel parking with regular tree planting within kerb build outs reducing its impact on the street space (Section)



Street incorporating trees and parallel car parking

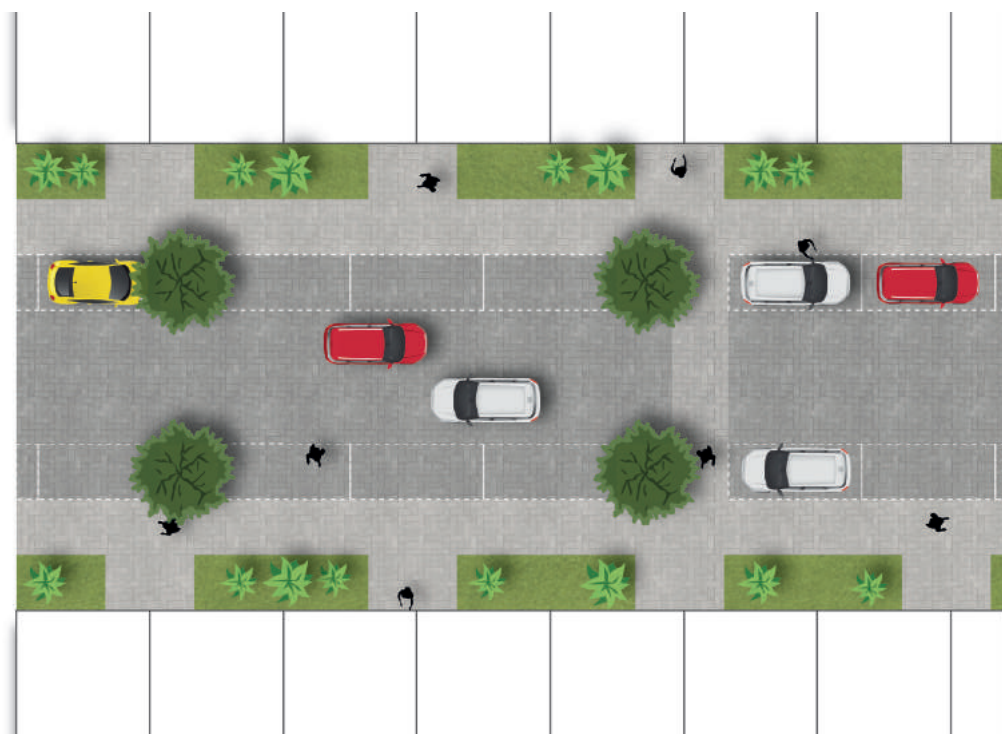

Figure 5.22: A good formal arrangement for a primary street that incorporates parallel parking with regular tree planting within kerb build outs reducing its impact on the street space (Plan)

#### On street parking

5.7.7 On-street parking for residents provides convenient spaces adjacent to properties and adds to the activity of the street and natural surveillance. On-street car parking also avoids vehicle crossovers on the pedestrian footway.

5.7.8 Lines of on-street parking spaces should be broken up into blocks of a maximum of 5 parking bays separated by kerb build-outs which may accommodate street trees, planting and pedestrian crossings.

5.7.9 Streets must be designed so that where on street parking is proposed there is adequate width to accommodate this parking without causing an obstruction to the highway (refer to VALP Appendix B).

5.7.10 On street parallel parking is a good solution for main streets where it can form part of a formal arrangement that aids legibility of the development. Parking must be designed with particular care to minimise visual impact, enable free movement of buses (where appropriate) and retain continuity of footways.

# 5. Site layout, streets and spaces

## Parking

VALP Policy Refs: T5; T7; Appendix B



Parking square broken up by mature planting which 'softens' the appearance of parked cars



Car parking discretely located to the side of property



The use of gates rather than garage doors can be beneficial in ensuring the space is used for parking cars and not storage



Car parking discretely located to the side of property



Entrance to parking area under apartment block is made discrete by attractive metalwork panels



Parking in front of properties together with a lack of planting creates a somewhat bleak streetscape

### Parking Squares

5.7.11 Large unsightly expanses of hard surfacing or blacktop should be avoided. Parking squares may offer flexible use including providing space for events or markets and parking should normally be set out in marked bays to ensure efficient use of space. Permeable paving is encouraged in these areas.

### On plot parking

5.7.12 On plot parking can take a number of forms some of which contribute better to the quality of the street environment.

### Within car ports or garages

5.7.13 This solution also allows buildings to be close to the street. Integral garages should be used sparingly as they reduce animation of the street at ground level.

### Within undercrofts or basements

5.7.14 Appropriate for apartment schemes. This is generally an acceptable solution provided that a positive interface between the building and street is provided and entrances to car parking areas are designed to minimise intrusion on the street space.



## 5. Site layout, streets and spaces

### Parking

VALP Policy Refs: T5; T7; Appendix B

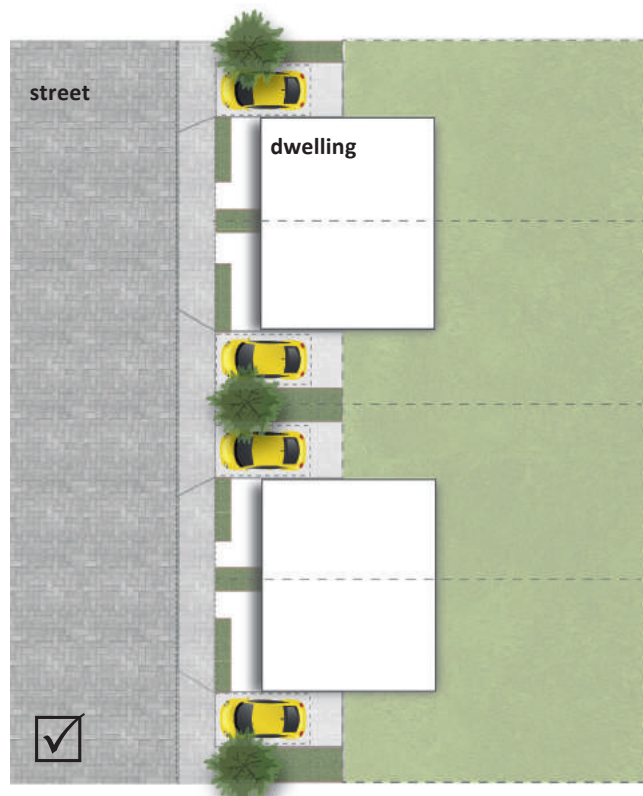

Figure 5.23: Car parking spaces to the side of dwellings reduces the visual impact of cars on the street and allows buildings to be located closer to the back of kerb increasing the sense of enclosure

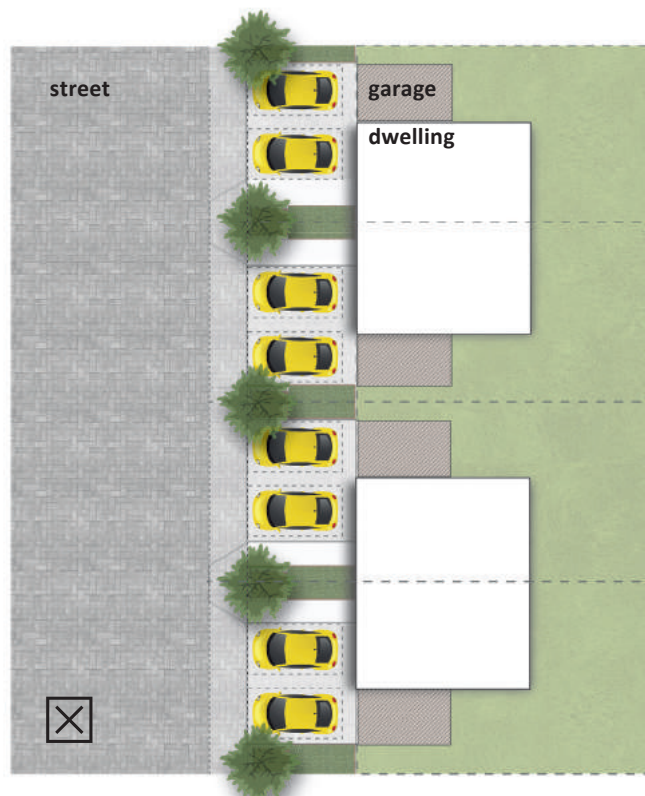

Figure 5.24: Car parking spaces in front of dwellings results in wider streets and could deliver a streetscape dominated by parking. Planting and co-ordinated boundary treatments can reduce the visual impact

#### To the side of dwellings

5.7.15 This allows buildings to be closer to the street space with car parking less visible from the street. Tandem parking arrangements avoid over-wide separation gaps between building frontages but must provide adequate space for two vehicles in order to avoid the front vehicle overhanging the footway. Triple stacked car parking will not be acceptable. Where adjacent plots adopt the same approach, care must be taken to avoid over wide gaps between dwellings that are dominated by walls, cars and hardstanding.

#### To the front of dwellings

5.7.16 Whilst this is historically a popular model it necessitates wider streets, tends to have a considerable visual impact and can restrict informal surveillance of the street space. Parking to the front of dwellings should generally be avoided except in rural locations and where it is proposed its visual impact must be reduced through appropriate boundary treatments and landscape.

#### Rear parking courts

5.7.17 Applicants should avoid rear parking courts whenever possible. Where they are proposed they should be small scale, overlooked, gated and only serve properties that are located around the court. Entrances to parking courts should be carefully designed to create a semi-private appearance and courts should be secure.

# 5. Site layout, streets and spaces

## Plan for cyclists

VALP Policy Refs: T5; T6; Appendix B

### 5.8 Design for cyclists

#### Principle DES28: Plan for cyclists

##### Cycle network and routes

Applicants should plan for walking and cycling when preparing their proposals in order to support the council's target to significantly increase the number of short local journeys being made by sustainable modes.

At a strategic level applicants must consider how their site may help to deliver the objectives of the new Aylesbury Local Cycling and Walking Infrastructure Plan, extend existing routes and integrate cycle routes with the cycle network in the town. This includes providing safe and direct routes between destinations in the Vale and adjacent areas.

All new cycle infrastructure should comply with guidance as set out in the Department of Transport Local Transport Note 1/20 Cycle Infrastructure Design (July 2020). This guidance is founded on best practice and on five core design principles; that networks and routes should be Coherent, Direct, Safe, Comfortable and Attractive and that they should be accessible for all.

##### Cycle parking and storage

Space should be made available within new development for parking of bicycles in accordance with the council's cycle parking standards.

Secure, covered cycle storage should be accommodated in a convenient location within each residential plot, within the rear garden, car port, garage or outbuilding.

Secure and convenient cycle storage for apartments should be provided within the main buildings, preferably close to main entrances. External communal stores are usually inappropriate as they are unlikely to offer convenient access for all residents and they are less secure. Large separate bicycle storage buildings that do not benefit from good natural surveillance should be avoided.

Dedicated visitor cycle parking should also be provided for apartments close to main entrances and well overlooked by habitable rooms with care being taken to ensure that such provision is carefully integrated into the design of the space.



Positive promotion of cycling in Aylesbury town centre

#### Reason

5.8.1 For cycling to become an attractive alternative to the car a network of attractive, safe and convenient cycling routes must be provided across the area. The Council has set a target for Aylesbury Garden Town, for half of short local journeys to be made by sustainable modes by 2050.

5.8.2 It is also important that bicycles are readily accessible and can be securely stored. It is generally recognised that if secure cycle storage is conveniently located within individual dwellings or close to entrances, cycles are more likely to be used. This usually means locating cycle storage close to a buildings entrance at the ground floor level.

5.8.3 The type of storage will depend largely on the type of dwelling and the scale of the development. For houses a flexible storage space could be provided for bins, cycles and other items (e.g. e-scooters). Refer also to Principle DES31.

# 5. Site layout, streets and spaces

## Plan for cyclists

VALP Policy Refs: T5; T6; Appendix B

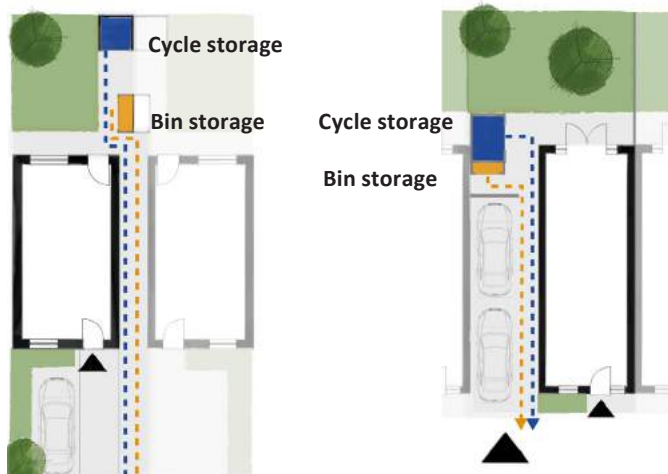

Figure 5.25: Accommodating refuse and cycle storage in rear garden for semi-detached house

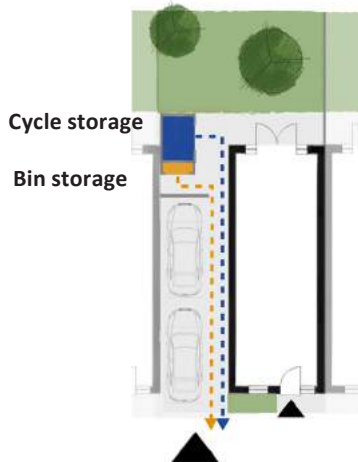

Figure 5.26: Accommodating refuse and cycle storage to rear of car port

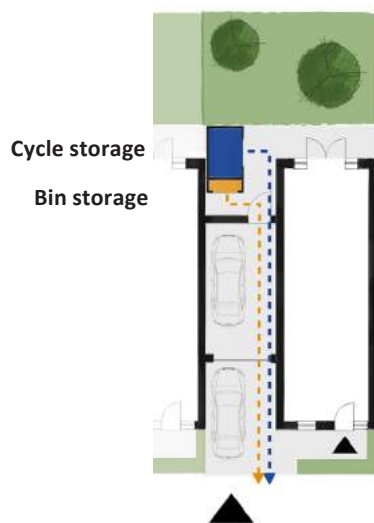
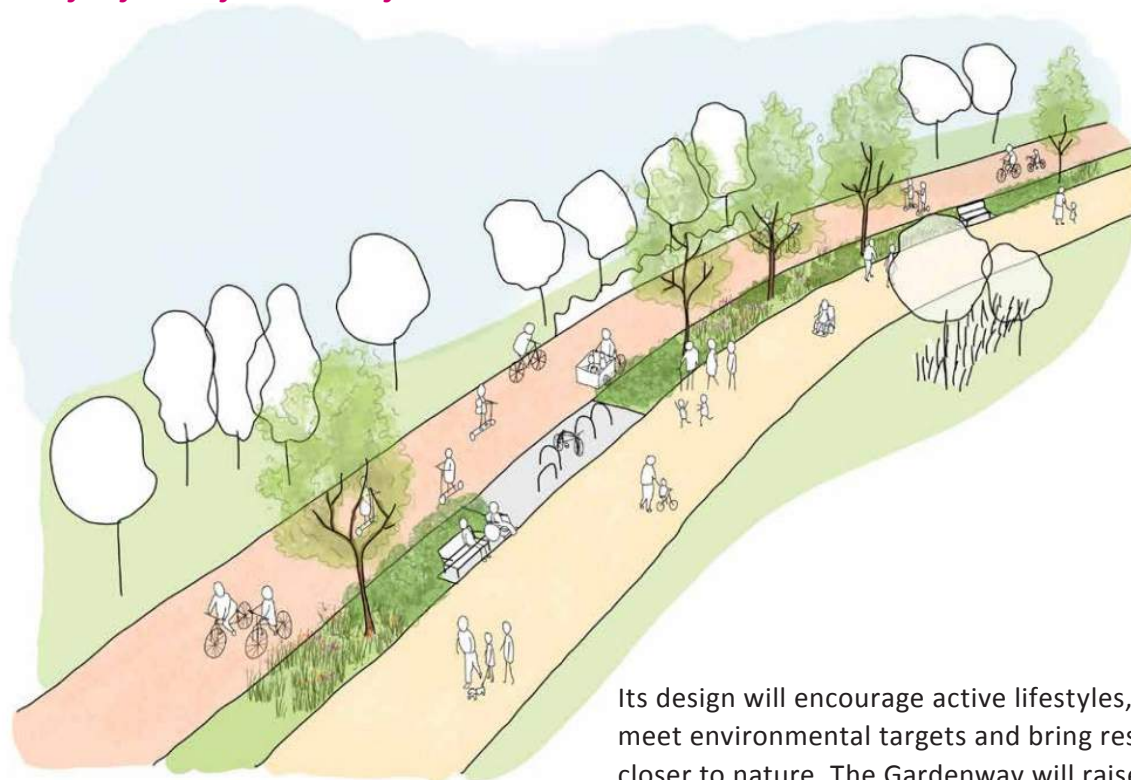

Figure 5.27: Accommodating refuse and cycle storage to rear of garage

### Case study: Aylesbury Gardenway



Aylesbury Gardenway orbital park is a proposed segregated route for walking, cycling and wheeling around the town, regardless of age, sustainable mode or ability. It will help set the standard for future cycleway provision in towns and villages throughout Buckinghamshire.

It is designed to make sustainable modes of transport more attractive, and preferable to using the car for short local journeys. It will help achieve the council's target of half of short local journeys being made by sustainable mode by 2050.

Its design will encourage active lifestyles, help meet environmental targets and bring residents closer to nature. The Gardenway will raise the standard of crossing provision for people walking, cycling and wheeling. Crossing points will be designed to ensure everyone is able to safely and comfortably cross the road in accordance with the modal hierarchy required by VALP.

The Gardenway route will upgrade and improve junctions for walking, cycling and wheeling, applying high design standards and the latest best practice. Cycleway infrastructure on the Gardenway will comply with Local Transport Note 1/20 Cycle Infrastructure Design (July 2020).

# 5. Site layout, streets and spaces

## Commercial areas

VALP Policy Ref: BE2

### 5.9 Layout of commercial areas and infrastructure

#### Principle DES29: Deliver attractive and efficient employment areas and infrastructure

New employment areas or infrastructure should be accommodated sensitively to their context. Where they are adjacent or visible from the countryside, a generous landscape buffer will normally be needed to integrate the development sympathetically into the landscape context.

New employment areas should be accessible by non-vehicular modes and public transport, be well connected to the wider area and structured as a network of connected streets with development fronting those streets, wherever possible.

Development within new and existing employment areas should take a landscape led approach focusing investment in areas that will significantly contribute to the quality of the workplace environment.

Development should:

- Be laid out so that new buildings front onto streets with parking and servicing provided to the rear. A servicing strategy demonstrating safe access and egress should form part of the application;
- Establish a coherent and common design language throughout an employment area with a design code prepared for outline schemes;
- Provide quiet, open space with areas of shelter within an easily-accessible central location, where it can form a focus for the site;

- Enhance the street environment and establish a clear street hierarchy through planting of street trees and enhancements to footways and cycle routes; and
- Rationalise parking so that it has less impact on the street and break up larger expanses with planting and trees and provide charging points for electrical vehicles.

Existing employment areas are often located adjacent to residential areas and the interface between the two uses must be carefully considered to avoid overshadowing, loss of daylight or impacts on privacy (refer also to Principle DES42 and DES44).

Where employment areas or infrastructure are located in the countryside particular consideration must be given to visual impact. Commercial buildings or infrastructure by virtue of their size can have significant impact on their landscape setting.

Buildings or infrastructure should be sited where their impact is minimised, avoiding elevated ground and wherever possible utilising existing vegetation to act as a visual screen. Careful consideration must be given to materials, colours and finishes to reduce visibility. Generally muted colours and tones should be used and reflective materials avoided.

For larger employment buildings consideration should be given to sub-dividing structures and articulation of roofscape to reduce the apparent bulk and massing.



Office buildings set within green environment at Farnborough Business Park

#### Reason

5.9.1 Employment areas and infrastructure can have significant visual impact on the landscape or on the quality of place within settlements if not carefully planned.

5.9.2 Many of the employment areas in the area have evolved over time without a clear plan and present an environment that is unattractive for pedestrians and cyclists, that is dominated by car parking and service yards and that lacks trees and landscape.

5.9.3 There is often little amenity for employees and in many cases land is not used efficiently.

# 5. Site layout, streets and spaces

## Commercial areas

VALP Policy Ref: BE2



Buildings set within large areas of hardstanding should be avoided



Office building is set back from the street and the entrance is not obvious

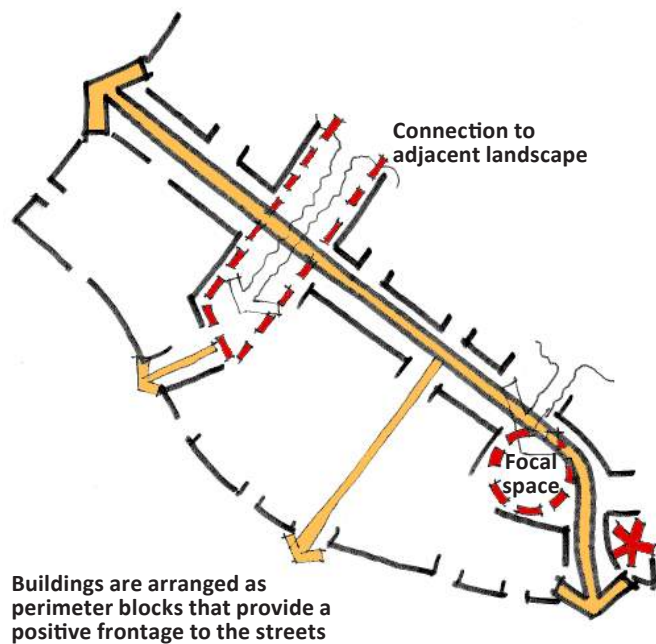

Buildings are arranged as perimeter blocks that provide a positive frontage to the streets

Figure 5.28: Concept for employment area indicating primary route as boulevard, central space and key gateway buildings



Figure 5.29: Layout plan showing indicative block layout with frontage and entrances overlooking the boulevard



Figure 5.30: Service yards and parking should be internalised within the perimeter block to reduce impact on the street environment

# 5. Site layout, streets and spaces

## 5.10 Refuse, storage and utilities

### Principle DES30: Consider and allow for servicing, refuse collection and deliveries

The layout of development should be designed to facilitate service vehicles and refuse collections. The layout should be tested and tracked to ensure that this can be facilitated. A connected network of streets helps in this regard avoiding the need for large turning areas for servicing vehicles.

Consideration must be given to the storage and collection of bins at individual and communal properties, making sure residents are able to move bins easily to collection points, that bins are located conveniently for residents and that collection vehicles can access designated bin storage areas, minimising the risk of bins impacting negatively on the streetscape.



Bin stores is located within parking spaces and appears to be an afterthought

### Reason

5.10.1 If not properly planned for refuse collection and storage can have a significant detrimental impact on the quality of the streetscape.

5.10.2 Applicants should refer to the AVDC Recycling and Waste Advice Note for Developers 2019.

5.10.3 In accordance with the recommendations in Manual for Streets residents should not be required to carry waste more than 30 metre (excluding any vertical distance) to the storage point; waste collection vehicles should be able to get to within 25 metre of the storage point and the gradient between the two should not exceed 1:12.

## Refuse storage and utilities

VALP Policy Ref: BE2



Bin store obscures building frontage and presents a poor outlook from properties

## 5. Site layout, streets and spaces

### Principle DES31: Integrate refuse and recycling into the design of new development

Facilities for refuse and recycling storage should be:

- A suitable size to accommodate all the refuse and recycling containers to meet the needs of residents and be of a size acceptable to the refuse collection service;
- Located where they are neither visually obtrusive or where they obstruct passive surveillance of the street;
- Located where they will not be obstructed by car parking;
- Within secure and well ventilated areas; and
- Located so that they may be easily accessed from properties but where they will not cause nuisance through unpleasant odours or noise; and
- Coordinated with cycle storage (refer to Principle DES28 and Figures 5.25 to 5.27).

### Principle DES32: Plan for and integrate sub-stations, utilities and pump stations into the design of new development

Enclosures for utility services including sub-stations and pump stations should be carefully designed and integrated into development so that they do not detract from the quality of streets and public spaces.

Utility runs should normally run under the footway or carriageway and the location should be carefully planned so that it does not impact on the potential for street tree planting.

#### Reason

5.10.4 Consideration of the location of refuse storage and utilities apparatus must take place early in the design process as they can have considerable impact on the quality of environment within a development.

5.10.5 Applicants should refer to the AVDC Recycling and Waste Advice Note for Developers 2019. This provides details on the size and capacity of bins for residential and commercial properties and general requirements on their location.

## Refuse storage and utilities



Refuse areas should be considered as part of the design of the buildings. If refuse areas are located to the front of the building they should be designed as an integral part of the elevation



Locating sub-stations within areas of open space will not be acceptable



Sub-station is free-standing and prominent at the end of the street and impacts negatively on the residential development

# 5. Site layout, streets and spaces

## Open space / public realm

VALP Policy Refs: NE6; NE8; I1; I2; I4; I5

### 5.11 Open space, public realm and water space

#### Principle DES33: Enhance the environment and sense of place through open spaces

Open space should play an essential role in structuring a development, forming part of the wider green infrastructure network. Open space should be multi-functional, creating places for people, nature and providing natural capital, ecosystem services and climate resilience. They should be accessible throughout the year.

Careful consideration needs to be given to the function and users of the space, alongside the balance between amounts of hard and soft landscape. Design and materials for hard surfacing should be selected based on location, the anticipated use and level of activity and should incorporate the use of sustainable drainage systems to reduce pressure on the sewage system. Where furniture and equipment are provided, their design should be attractive, robust, durable, coordinated and appropriate to the context.

The open space network may comprise a variety of formal and informal spaces defined by buildings which front onto the open space to overlook and provide appropriate enclosure, enhancing natural surveillance. Open space provided alongside proposed residential development should include, but is not limited to: children's play areas, informal green space, wildlife and recreation areas, street trees, community orchards, woodland, parkland, playing pitches and pavilions.

The long-term management and maintenance of open space and public realm should be accounted and provided for, with consideration given to the selection of materials, furniture and fixings, allowing for longevity and making provision for the cost of ongoing maintenance which should be undertaken by a suitable stewardship body.

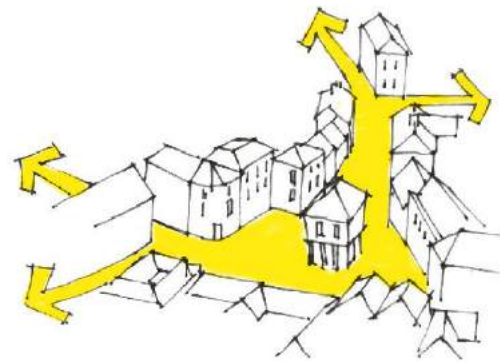

Figure 5.31: Informal space and buildings

#### Reason

5.11.1 Open space creates an opportunity to reinforce a sense of place, as well as building stronger cohesion between new and existing settlement. They can be the focus for social interactions, play, recreation, travel and events; they should therefore be multi-functional and central to development.

5.11.2 Spaces should be designed to cater for specific uses designed in anticipation of the type and level of use and activity that may take place within them. Potential changes of use throughout the year should be considered, as well as how people are going to move through the space.

5.11.3 Previous studies into the local context and surrounding character of the site should be drawn upon (Chapter 3) when designing the open space, as well as responding to existing settlement needs.

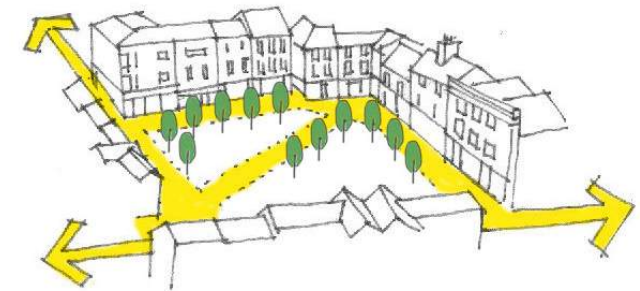

Figure 5.32: Formal space with semi-formal building

5.11.4 Applicants should refer to the AVDC Assessment of Open Space, Sports and Recreation Needs for Aylesbury Vale (and forthcoming strategies) for the required type and amount of open space and areas for sport, play and recreation.

5.11.5 The historic environment should be a source of inspiration when considering the design of open spaces and the public realm. Applicants should refer to Historic England guidance 'Streets for All' and which provides practical advice on highways and public realm design and implementation of works in sensitive historic locations.

5.11.6 Long-term management and maintenance of open spaces should be considered at an early stage in the design process.



## 5. Site layout, streets and spaces

### Open space / public realm

VALP Policy Refs: NE6; NE8; I1; I2; I4; I5



Open space creating a focus for new development

#### Natural surveillance

5.11.7 It is important that spaces around buildings, foot and cycle path routes and open spaces are overlooked by the occupiers of buildings or bypassing pedestrians or motorists. Building entrances and windows looking out over pathways or other public areas will create an impression of observation and deter anti-social activity. Entrances to buildings should be visible from the street. Consideration should be given to locating kitchen and bay windows to the front elevation of houses to provide increased surveillance.

5.11.8 A balance must be achieved between maintaining adequate privacy and allowing natural surveillance. It is possible to design groups of buildings so that they have reasonably unobstructed views of neighbouring buildings and frontages, open spaces, parking areas and pathways. This principle can be applied to both residential and commercial buildings.

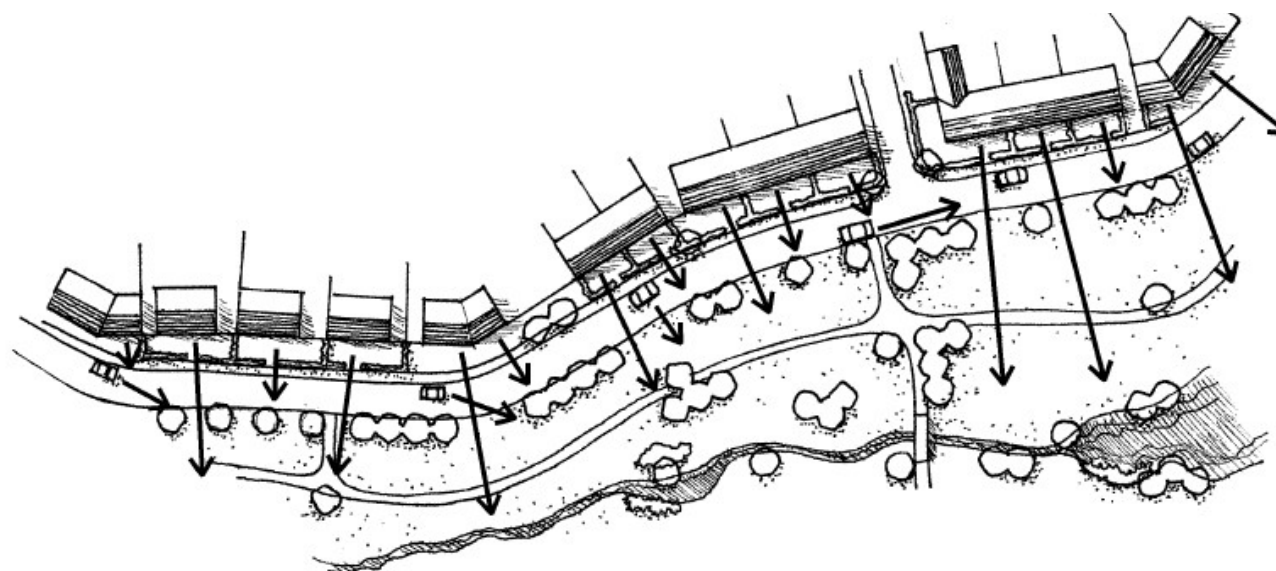

Figure 5.33: Buildings providing enclosure and natural surveillance over adjacent open space

### Principle DES34: Integrate space for play into the design

Play areas and equipment should be integral to open space within housing developments and should be overlooked by surrounding houses and by passing pedestrians. Other equipped play and informal sports/recreation provision (e.g. MUGAs, skate parks, bmx pump tracks) should also be overlooked and all aforementioned provision should adhere to current Fields in Trust guidance regarding their minimum buffer distances from residential dwellings and boundaries.

Provision of play and sports facilities within proposed developments should meet the quantity and standards set out in VALP Appendix C and D and national standards referenced below. Applicants should ensure that all designs and built play spaces achieve a minimum rating of 'Good' against criteria set out in RoSPA's 'Play Value Assessment'; this includes both Local Equipped Area for Play (LEAPs) and Neighbourhood Equipped Area for Play (NEAPs). Local Area for Play (LAPs) should be included in the same location as LEAPs, however the amount should be in addition to that provided for the LEAP.

Play and sports areas are required to meet the requirements of the Equality Act 2010, therefore consideration should be given to the overall safety of the facilities, ease of access and the furniture and facilities provided. Adequate bins should be provided with reasonable access for maintenance, in accordance with the Environment Protection Act 1996.

A range of play equipment should be provided to cater for a variety of experiences, abilities and ages, whilst encouraging group play. Safety surfacing should be complimentary to the play area and the overall character of the development.

Fencing of play areas should be avoided unless a hazard is present nearby, such as a road or water, sand play is included or it is needed to comply with national standards. Where fencing is required robust and durable pedestrian self closing gates with anti-rebound mechanisms should be included. Where fencing is not required alternative informal landscaping and placement of seating can be used to indicate the play areas boundary. No underground services should run under equipped play provision

If signage is required it must be prominent at entrances, carefully designed as an integral part of the open space. Seating should take both children, parents and carers into account. Planting should ensure that views in and out of the play area are maintained, permitting natural surveillance from overlooking building frontages, whilst reinforcing the scale and character of the surroundings.



Play spaces should be integrated into the overall site layout and overlooked by development providing natural surveillance and opportunity for independent play

### Reason

5.11.9 Facilitating play is essential for children's well-being, both physically and emotionally. The freedom for exploration and creativity enhances learning, problem-solving and interpersonal skills. A variety of play types should be provided, including for example rocking, swinging, climbing, sliding, rotating, swinging and multiplay units that provide imaginative and encourage group play.

5.11.10 On larger developments, major play space should be located in accessible locations, helping to create a hub of activity, community focus and ensuring facilities are sustained.

5.11.11 Applicants should liaise with the council's planning, parks and landscape teams at an early stage of the design process, before the locations of play spaces have been decided to seek guidance on integrating facilities within the proposed development.

5.11.12 A robust palette of materials and textures should be used which meets the functional, environmental and adoption requirements of the play space as well as the character of the area. Where timber equipment is considered appropriate, it should have a minimum 15-year warranty and metal footings should be used to increase longevity of the equipment.

## 5. Site layout, streets and spaces

### Open space / public realm

VALP Policy Refs: NE6; NE8; I1; I2; I4; I5

#### Principle DES35: Enhance the environment and sense of place through tree planting and soft landscape

Applicants should recognise the importance of tree planting and soft landscapes in creating and adding to an area's sense of place and legibility, by providing a landscape strategy for proposed development and how this integrates with the green infrastructure of the wider area. Wherever possible effort should be made to retain high value trees especially where opportunities for new planting are limited

Species selection should take into account the local species of the area, in combination with design objectives and assessing species suitability in relation to climate change, pest and disease tolerance and prevailing environmental conditions, such as soil type and drainage. Use of native species is desirable in development adjacent to the open countryside as they are locally distinctive and help to provide continuity in habitats.

Planting designs should have a clear objective, theme and aims with the level of formality and enclosure defined. Formal tree planting and tree species that grow to a larger size should be provided on main streets and at key junctions to reinforce their importance in the street hierarchy and provide landmarks. Seasonality within the Vale should be reflected in the area's public realm planting, rather than adopting standard planting combinations.

Applicants should consider incorporating edible landscapes, to reflect the importance of orchards in the Vale for their landscape and habitat value.

Applicants should seek expert advice from the appropriate professionals (landscape architects, horticulturalists, arboriculturists and ecologists) to help inform planting design, selection, establishment and management. Design schemes should be accompanied by an Arboricultural Impact Assessment in accordance with BS5837. The cost of management and maintenance should be considered, and adequate funding provided.

The proposed planting palette, future maintenance and management should be discussed and agreed with the council prior to submission of an application.

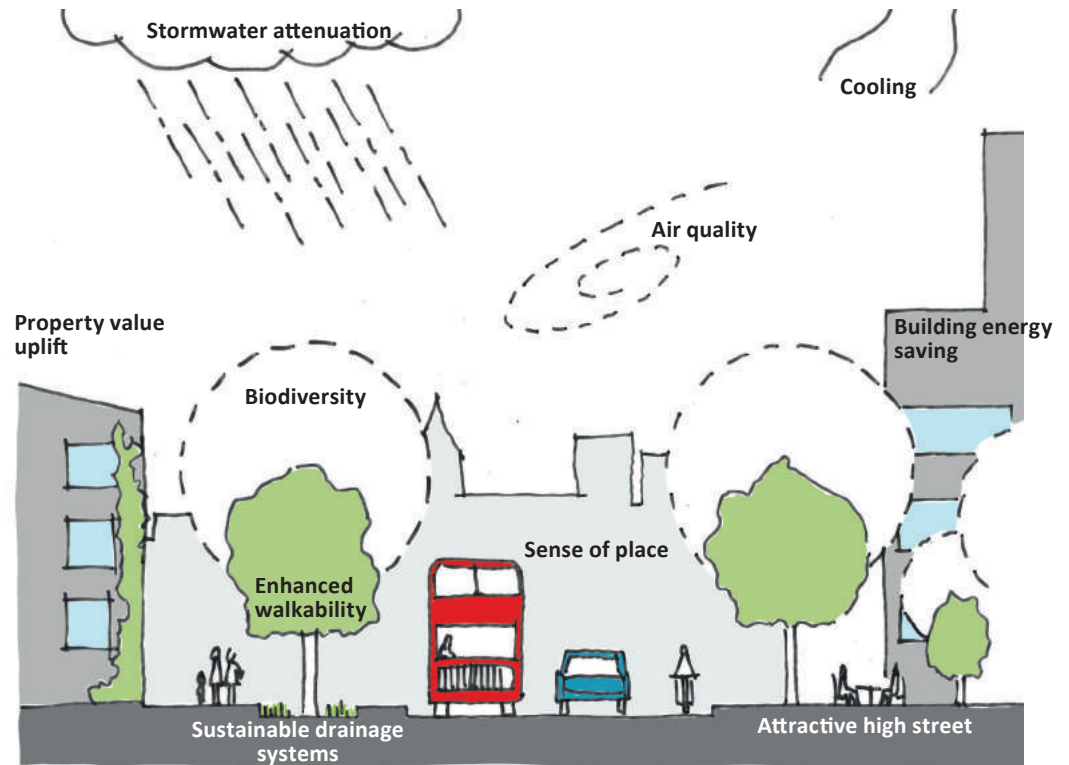

Figure 5.34: The benefits of tree planting and soft landscaping

#### Reason

5.11.13 Tree planting is a vital part of enhancing existing and developing new character and sense of place. From the outset of open space design, the nature of a landscape and how it matures should be considered, particularly in relation to ultimate size, lifespan and maintenance requirements of plants and trees.

5.11.14 Retaining, improving and connecting existing trees, hedgerows and vegetation as part of the design of the development should be prioritised as new planting may take many years to realise its full suite of benefits.

## 5. Site layout, streets and spaces

### Open space / public realm

VALP Policy Refs: NE6; NE8; I1; I2; I4; I5



Formal street tree planting provides definition between footpath and road, as well as breaking up and softening built form



A residential street with little planting results in a hard environment, dominated by cars

5.11.15 The multi-functional benefits of trees and vegetation include aesthetic value, visual screening, shelter, recreation, cultural significance, CO<sub>2</sub> absorption, cooling properties, pollutant removal, improving air quality, reducing surface run-off and habitat value. Maintenance regimes of trees and vegetation should be relaxed where appropriate to encourage greater structural diversity and increase the number of species niches.

5.11.16 Planting design and species selection should take the landscape context into account and emphasise 'the right tree, right place' approach whilst not adversely impacting on biodiversity.

5.11.17 New planting proposals should take account of the full design life of the development. Generally, larger trees should be used when space permits and short-lived species should be avoided. Developments should aim to maintain or increase vegetation canopy cover on a site.

5.11.18 If tree and vegetation removal is required as part of the development, then replacement planting should compensate for its loss and wider value in terms of size, quality, amenity and species.

5.11.19 Applicants should consider environmental issues that affect trees and vegetation, including climate change and biosecurity. This could include the use of different cultivars which are more appropriately adapted to warmer conditions or more tolerant to pests and disease.

5.11.20 To ensure tree planting is future-proofed best practice guidance should be followed including 'BS 8545:2014 Trees: from nursery to independence in the landscape' and Trees and Design Action Group 'Trees in Hard Landscapes: A Guide for Delivery'.

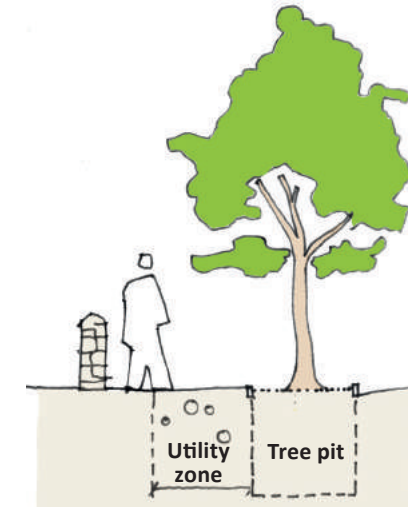

Figure 5.35: Professionally designed tree pits should be used to provide the necessary soil volume required to successfully establish the tree. Tree pit design needs to consider any adjacent service runs and particular care is needed for trees in hard surfaces

## 5. Site layout, streets and spaces

### Open space / public realm

VALP Policy Refs: NE6; NE8; I1; I2; I4; I5



Tree planting enhances this recent residential development



A lack of tree planting contributes to a bland and uninviting streetscene

5.11.21 Whilst creating tree avenues and blocks of a single species helps to deliver character and legibility, applicants should avoid large numbers of the same species to safeguard against the risk of tree losses through climate change, pest and disease. Species with similar characteristics can be selected to create similar effects as single species planting, or species changed by street, which is preferred. Modern approaches to planting should also be used, including structural tree pits, rooting break out spaces and root barriers to provide the best environment for tree establishment, health and longevity, and to protect pavements, other surfaces and utilities.

5.11.22 The following broad themes for new planting should be considered:

- **Aylesbury:** a bold and distinctive pattern of new planting has begun to develop along major roads, further enhancing distinctiveness. Open spaces on the edges Aylesbury should aim to increase the proportion of native species, and major parks should use distinctive species which are appropriate to the conditions and existing context of the park. The town centre should use specimen trees or formal groups where space allows.
- **Riversides and watercourses:** use native riparian species, in particular consider using the locally distinctive and nationally rare Black Poplar.
- **Rural locations adjacent to the countryside:** use native species unless special circumstances favour mixed species planting.

5.11.23 When designing soft landscape (planting) the following factors should be considered:

- The existing character and context of the area;
- The character and function of the proposed development, whether it will be formal or informal;
- Whether the planting aims to enhance local distinctiveness;
- The space available for growth above and below ground;
- Final anticipated shape of plant or tree, including height and spread;
- How the soft landscaping will change throughout the seasons, and whether this could have an impact on its function i.e. screening views;
- The tree strategy in conjunction with existing and new services both underground and overhead. Well considered tree pit design can successfully function alongside services, seek advice from specialists where necessary; and
- How growth will affect natural surveillance of public realm or open space and whether maintaining surveillance requires high maintenance regimes.

## 5. Site layout, streets and spaces

### Principle DES36: Deliver a high quality, coordinated and attractive public realm that is easy to manage and maintain

Public realm (the streets and spaces around buildings) should be designed and maintained to a high standard, using a robust, sympathetic and locally distinctive palette of materials with limited clutter.

Historic elements of the public realm, the street surfacing, street furniture, lighting and the historic buildings and features that enclose them including shopfronts, are a valuable asset and contribute strongly to an area's historic character and sense of place. These features should be protected and maintained, where they survive, and used as the starting point for designing the public realm around them.

Materials which complement the surrounding context of the Vale should be used (see 3.3 Landscape character and 3.5 Settlement character). Natural stone either as flags, setts or cobbles or brick may be the most appropriate, particularly in historic and rural locations. Concrete or tarmac should be used with care as their uniform appearance and sharp finish can detract from the character of a new development.

Public art should be integrated into the public realm to create a focal point of incidental joy and richness to reflect heritage and culture and can be created with community engagement.

Lighting and street furniture should be robust, functional and high quality. The importance of reducing street clutter should be recognised by the applicant, and therefore functions should be combined when possible, for example retaining walls with benches, or lighting columns with signage. Consideration should also be given to the mounting of street lighting or street name plates on buildings to remove the need for unnecessary columns. Lighting should be carefully designed to be low energy and take account of areas of sensitive habitat or locations defined as having dark skies.

The location of new and existing utilities should be considered at the beginning of the design process, with every effort being made to facilitate easy access and limitation of damage to trees. Underground utilities should be aligned with paths and not interfere with soft landscape areas.

The proposed palette of materials and furniture should be coordinated with the surrounding context, discussed and agreed with the council prior to submission of an application and consideration given to long term maintenance and management.

## Open space / public realm

VALP Policy Refs: NE6; NE8; I1; I2; I4; I5



High quality public realm in Aylesbury town centre incorporating public art as part of the streetscene

### Reason

5.11.24 Alongside its buildings, a settlement's public realm is the most important aspect of development for reflecting local character and context, People's experience and perception of a place is often defined by the public realm, forming the stage for community cohesion and engagement.

5.11.25 There are many elements that contribute to a successful public realm, including: permeable and legible spaces that are welcoming, easy to use and maintain, the use of high-quality materials in a simple palette to complement the existing context, well detailed hard and soft landscape that is long-lasting, varied and well-maintained, tree planting, and the inclusion of public art.

5.11.26 Public realm schemes often work well when they are first completed but if they are not easy to maintain or if replacement materials are expensive or difficult to obtain then their quality can rapidly diminish. Careful thought must therefore be given to management and maintenance from the outset.

# 5. Site layout, streets and spaces

## Open space / public realm

VALP Policy Refs: NE6; NE8; I1; I2; I4; I5

### Public realm quality



Planting can transform the public realm but consideration must be given to maintenance



A coordinated materials palette is important in public realm design



High quality palette of materials complements development setting



Trees and artwork can provide shelter



Lighting can transform a space at night



Public spaces provide opportunity for relaxation and social interaction



Seating allows people to enjoy a public space



Public spaces may form the setting for entertainment



USB charging points discretely designed into the public realm provide an additional attraction

## 5. Site layout, streets and spaces

### Open space / public realm

VALP Policy Refs: NE6; NE8; I1; I2; I4; I5

#### Principle DES37: Provide a positive response to waterways

Development should respond positively to existing waterways and water spaces and consideration must be given to how it will be viewed by recreational users from the water space or towpath. The waterways and canals in Aylesbury Vale pass through areas with different character; in some places they have an urban feel and in others rural. Development should seek to respect and maintain the existing character of the canal corridor.

The siting, configuration, and orientation of proposed buildings should optimise views of the water, generate natural surveillance of water space, and encourage and improve access to, along and from the water. Proposals must aim to avoid creating direct views of the developments 'back of house' from the canals outward perspective which heavily degrades the canals credentials as a green corridor. Back of house uses include car parks, service areas, bin stores, delivery areas, and sub stations. Development proposals should seek to minimise overshadowing of the waterspace.

Car parking areas that may be visible from the waterside should be visually screened through planting to soften its impact.

Development at the canal frontage must not adversely affect the structural integrity of the waterway.

A waterway's towing path and its environs should form an integral part of the public realm in terms of both design and management. Canal towpaths can provide safe, convenient and attractive traffic free routes for walking and cycling and provide linkages to local facilities, recreational opportunities. They can also help to promote health and well-being.

Development close to canal corridors should aim to enhance accessibility and fully integrate with the existing sustainable network and where appropriate upgrade towpath surfacing, providing new or improved access points and inclusion of wayfinding / interpretation boards.

Applicants proposing development adjacent to waterways should discuss their proposals with the Canal & River Trust at pre-application stage.



New residential dwellings at Marsworth Yard front onto the canal and have been designed with a contemporary wharfside architectural style



### How to use

This table provides a checklist for use by both the applicant and planning officer to check that appropriate consideration has been given to how an application has addressed the site layout, streets and spaces.

**PROCESS:** Have you read, understood and applied the principles set out above?

The adjacent table summarises the key principles set out within this chapter and can be used by the applicant and officer as a checklist.

**Applicants will be expected to demonstrate to the council that they have responded adequately to all relevant principles in preparing their proposals, or provide a justification for any failure to do so.**

Principle	Description	Check
<b>DES18: Inclusive design</b>	Has the applicant demonstrated that the principles of inclusive design has been considered and incorporated within the design from the outset?	
<b>DES19: Urban structure</b>	Does the design provide a clear street hierarchy and network of open spaces?	
	Does the design create a grid network of streets and perimeter blocks?	
	Do development blocks take account of natural features orientation and topography?	
<b>DES20: Enclosure</b>	Does the design provide enclosure of street space and continuous frontages with corners of blocks appropriately emphasised?	
	Does the proposal provide a sense of enclosure appropriate to the street hierarchy and achieve a human scale?	
<b>DES21: Mix of uses</b>	Does the proposal provide a mix of uses conveniently located to meet local needs? (where appropriate)	
	Are these uses located where they are easily accessible and visible to attract custom?	
	Are servicing areas designed so that they do not visually dominate the streetscene?	
	Is adequate cycle and car parking provided and in a convenient location?	
<b>DES22: Residential mix</b>	Does the proposal provide a mix of residential dwelling types and tenures to meet local need?	
	Are affordable homes 'pepper-potted' throughout the site, and have the same external appearance and quality of finishes as private housing?	
	Are buildings designed so that they can be altered internally or externally over time without the need for demolition or rebuilding as needs change?	
<b>DES23: Density, scale and massing</b>	Does the proposal respond to the scale, height and massing of its context?	
	If it is at a greater density is this adequately justified?	
<b>DES24: Legibility, landmarks and vistas</b>	Does the structure or layout of the proposed development appear easy to navigate and easy to understand?	
	Has the applicant demonstrated how the use of landmarks, marker buildings and vistas has informed the proposal?	
<b>DES25: The development edge</b>	Has the applicant (where applicable) demonstrated how their proposals provides a positive edge with building frontages facing site boundaries served by roads that run adjacent to the site edge?	
	Has the applicant (where applicable) demonstrated a sensitive response to the rural edge? This will normally require less density and additional soft landscaping along the boundary.	

Principle	Description	Check
<b>DES26: Pedestrian friendly streets</b>	Are the proposals designed as social spaces with the needs of pedestrians, cyclists and public transport users put above the needs of the motorist?	
	Is the street environment designed to encourage pedestrian movement through appropriate pavement widths, avoiding unnecessary barriers or clutter and providing places for pedestrians to rest, gather and socialise.	
	Are the proposed pedestrian and cycling routes accessible to all members of the community?	
	Are traffic calming measures integrated within the design of the streets?	
	Has provision been made for pedestrians and cyclists to cross busier roads, e.g. formal crossing facilities or underpasses?	
<b>DES27: Car parking</b>	Is parking for both residents and visitors proposed at an adequate level in response to the location of the site and in locations that safeguard the quality of the street environment?	
	Is the parking provision in line with council parking standards?	
	Have electric charging points been incorporated into the proposals? (sites of >10 homes)	
<b>DES28: Plan for cyclists</b>	Does the proposal contribute positively to the network of cycling routes in the area?	
	Does the design provide adequate cycle parking in suitable locations for both public and private users?	
	Does the design include for secure and convenient storage of bicycles in residential dwellings?	
<b>DES29: Commercial areas and infrastructure</b>	Has the layout of employment areas or infrastructure (where appropriate) been designed taking a landscape led approach that minimises visual intrusion and responds to the landscape character and form.	
	Is the layout of employment areas configured to provide links to natural assets, creates open spaces for workers and minimise the impact of car parking and servicing?	
<b>DES30-32: Refuse, storage and utilities</b>	Has the layout of development been designed to facilitate service vehicles and refuse collections?	
	Are sub-stations and pump stations carefully designed and integrated into development so that they do not detract from the quality of streets and public spaces?	
	Are utility runs located where they do not impact on the potential for street tree planting?	
	Are refuse and recycling facilities conveniently located and unobtrusive	

Principle	Description	Check
<b>DES33: Open space</b>	Does the design link existing and proposed landscapes and open spaces to form green infrastructure networks and contribute and respond to the hierarchy of existing open spaces?	
	Are all spaces designed with a specific role or function to avoid residual, unused or neglected spaces?	
	Has consideration been given to the long-term management and maintenance of open space and public realm?	
<b>DES34: Play space</b>	Does the provision of open space meet the standards set out in the AVDC Assessment of Open Space, Sports and Recreation Needs for Aylesbury Vale (or replacement documents)?	
	Is the play provision integrated into the design of the development where it is overlooked?	
<b>DES35: Trees and soft landscape</b>	Does the design of the planting demonstrate clear objectives that respond to the place?	
	Has an understanding of the existing habitats (e.g. trees, hedgerows and woodlands) informed the design?	
	Has tree planting and soft landscape been provided within street designs? Are tree species appropriate for their location and to the nature and hierarchy of the street?	
	Has the applicant demonstrated that the species selected are appropriate for the location?	
	Has the applicant demonstrated that the long-term maintenance and management of landscape elements have been considered to ensure their successful establishment?	
<b>DES36: Public realm</b>	Has a suitable palette of high quality materials been proposed that responds to the character of the place as identified in the Character Study?	
	Has the selection of street furniture been restricted to essential items and have functions been combined where possible?	
	Is the street furniture simple, high quality, well designed, robust and responsive to its setting?	
	Has a lighting strategy been proposed that: minimises the impact of lighting columns on the streets; accords with the design approach to other street furniture and avoids causing light pollution particularly in sensitive and dark rural areas?	
	Has the location, design and integration of utilities within the landscape been considered to mitigate their impact on the public realm?	
	Has the provision of public art been considered?	
<b>DES37: Waterways</b>	Where relevant do the proposals respond appropriately with existing waterways and water spaces	



# 6

## High quality and sustainable building design

It is important that the design of buildings and in particular their form, proportions, roofscape and overall appearance is borne from the place and therefore contributes positively to the character of the existing settlement. All too often new development is built which fails to contribute to the distinctiveness of a place resulting in standard development that could be found anywhere. Being responsive to the character of the existing built form should not result in poor pastiche replicas, instead the emphasis should be placed on contemporary interpretation of traditional building forms to suit today's needs.

This chapter outlines the important principles to consider in designing new buildings. Housing makes a significant contribution to CO2 emissions in the UK. The construction industry utilises substantial volumes of non-renewable resources and generates pollution and waste. The need for sustainable approaches to building design is therefore fundamental if the challenges associated with climate change, resource depletion and pollution are to be addressed.



### 6.1 Deliver sense of place

#### **Principle DES38: Promote high quality buildings that respond to their location and deliver a sense of place**

Applicants should promote high quality buildings that provide a positive interface with street space, are designed from high quality robust materials and that respond to their location within the area. The council welcomes innovative and inventive design solutions and adaptable buildings that can accommodate changing lifestyles, including providing for an aging population and that challenge standard house types or development models.

#### **Scale, height and massing**

The scale of new buildings should relate to their context (rural or urban), to heritage sensitivities, to their location within the hierarchy of routes and whether they act as a focal point, landmark or corner building and the topography of a site.

Subtle variations in height can be used to add visual interest. This can be achieved with differing ridge and eaves heights, as commonly found in traditional streets. Similarly, variations in frontage widths and plan forms can add further interest to the street scene. This can be appropriate in both urban and rural locations.

The majority of traditional buildings in Aylesbury Vale, in both urban and rural areas, adopt a very consistent, simple form, with rectangular floorplans and pitched roofs over narrow spans. In most instances new development should adopt this simple form, with a rectangular floorplan and pitched roof unless a strong justification can be provided. Good contemporary design that respects context will be welcomed as long as it is well designed; equally traditional design approaches may be acceptable where a good understanding of materials and proportions is demonstrated. Poor pastiche approaches that aim to mimic historic vernacular but that are inappropriately proportioned, poorly detailed and fail to incorporate local materials will not be acceptable.

#### **Corner buildings**

Particular attention should be given to corner buildings (those located on the intersection of two streets). These buildings should be designed so that they 'turn the corner' providing active frontages to both streets; 'L' shaped buildings maintaining continuity of built frontage and incorporating corner windows and entrances will be welcomed in these locations.

Applicants should demonstrate how the design of corner buildings will aid legibility. Exposed, blank gable ends with no windows fronting the public realm will not be acceptable.

#### **Apartment buildings**

Corner locations are often suitable for apartment buildings where additional height may be appropriate to mark the corner. This will however depend on the character and context of the site. Apartment buildings will be welcomed on town centre sites, neighbourhood hubs, adjacent to important spaces or landscapes, nodal points, corners or the junction of major routes.

Apartment buildings may be deeper in floorplan than houses and as such care should be taken to avoid buildings appearing bulky. These larger buildings should be broken down into a hierarchy of simple rectangular elements and should step down adjacent to lower scale buildings.

Such buildings must maintain active street frontages with ground floor flats or duplex units having their own front doors and doors to lobbies / stairwells, used to access upper floors, also helping to activate frontages.

Single aspect, north facing apartments will not normally be acceptable.

## 6. High quality and sustainable building design

### Deliver sense of place

VALP Policy Ref: BE2

#### Reason

6.1.1 Many of Aylesbury Vale's towns and villages retain an attractive historic core which provides a strong character and sense of place. Many are designated as conservation areas reflecting the historic character. Development proposals should demonstrate an understanding of their historic context to build upon and reinforce the distinctiveness of their site and wider area.



6.1.2 Post-war development within the Vale is of mixed quality. In many cases it neither responds to local character or delivers distinctive or interesting contemporary accommodation that provides for the needs of modern living.



6.1.3 Whilst some recent developments offer good contemporary interpretations of the traditional building forms many developments rely on a pastiche design approach that present poor interpretations of the past and unsuccessfully imitate vernacular designs; typically they get the dimensions and scale of features wrong, over-simplify details or use inappropriate materials to save cost. This parody of the historic building forms sits uncomfortably within the context of the Vale and fails to offer a contemporary response to the changing lifestyles and accommodation requirements.



Contemporary design examples that respond appropriately to rural (left and bottom right) and urban contexts (top right)

These homes are a parody on the historic forms that they imitate with a scale, proportions and design detailing that fail to achieve a contextual response

## 6. High quality and sustainable building design

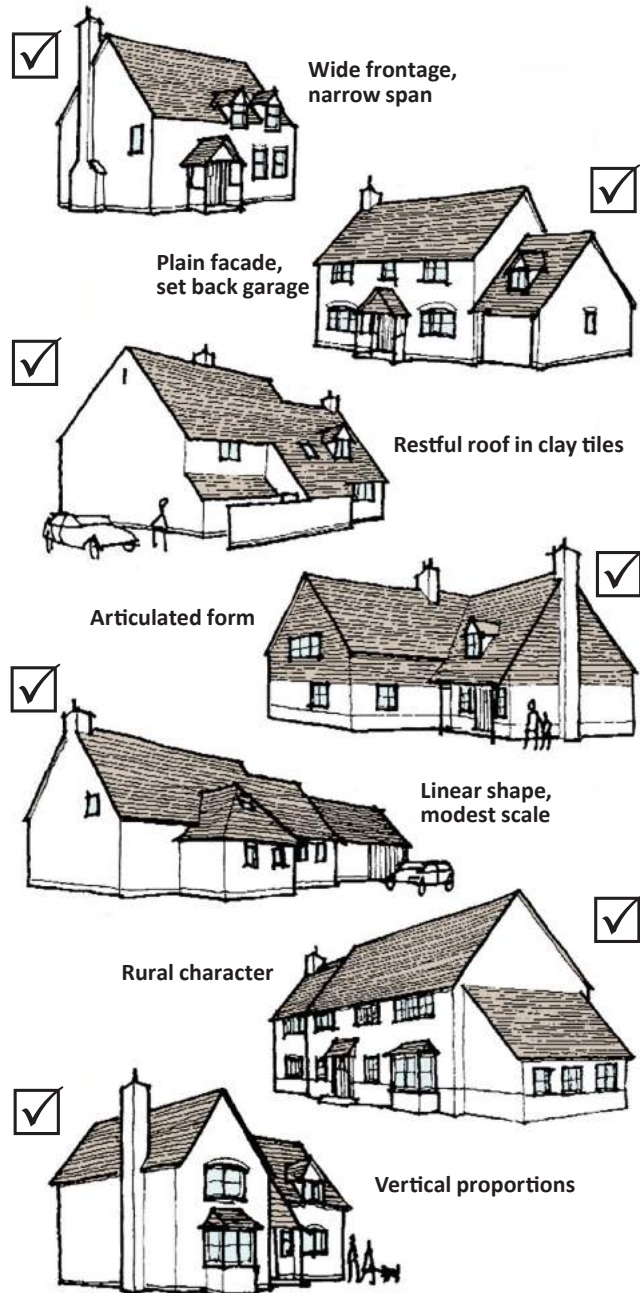

### Scale and massing

6.1.4 The use of local materials and historical construction techniques are largely responsible for the simple forms of traditional buildings in the District. In general, traditional houses in the area have a distinctly rural character, pitched roofs over narrow spans, and employ a limited range of materials. Sensitive interpretation of these characteristics is a preferred option for new development in a traditional context.

## Deliver sense of place

VALP Policy Ref: BE2



Figure 6.1: The majority of traditional buildings in Aylesbury Vale adopt a simple form, with rectangular floorplans and pitched roofs. Development should take cues from the prevailing forms within the context to strengthen local character



# 6. High quality and sustainable building design

# Deliver sense of place

VALP Policy Ref: BE2

Local materials - stone and clay tiles



6.1.5 Articulation of roofs and building form and a response to the surrounding built and landscape context enhances the quality and sense of place.

Large building broken down into separate elements



6.1.6 Buildings that are poorly proportioned or fail to respond to the scale and massing of adjacent properties have an adverse impact on their setting.

Building tied into landscape using natural materials



Linear property with garage at right angles



Visual interest and handmade roof tiles



Enclosure with garaging set-back



Poor relationship with adjacent property



Solid wall areas with discreet openings



Non-descript shape and impression of bulk



Varied scale, narrow spans and purpose made windows



Overdeep structure with horizontal emphasis and prominent garage

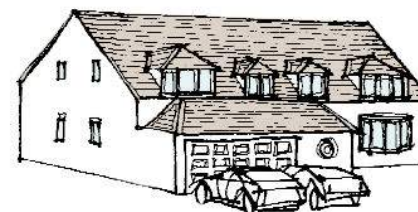

Prominent roof, chimney, articulated form



Simple traditional form with uncrowded facade



Figure 6.2: Applicants should assess the prevailing scale, form and massing of successful development within the locality to inform their proposals

## 6. High quality and sustainable building design

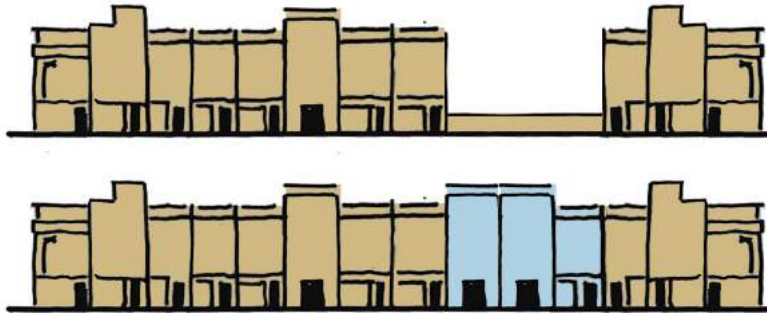

Figure 6.3: Development should reflect the scale, grain and diversity of the existing settlement

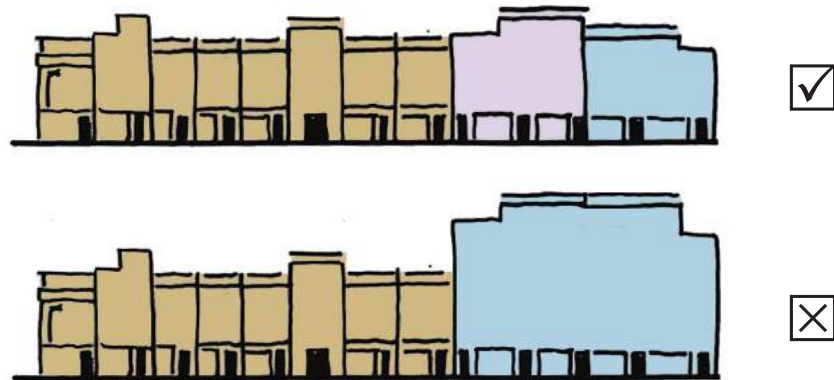

Figure 6.4: Apartment buildings should respond to the scale, massing and grain of the context in a complementary way and avoid becoming overbearing

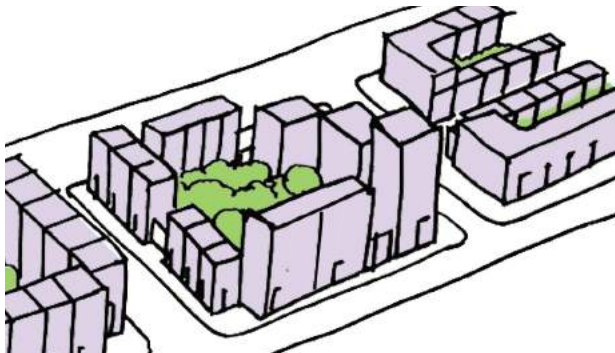

Figure 6.5: Apartments should be proposed at appropriate locations within urban areas and add to the legibility of an area

6.1.7 In town centre locations and within larger residential proposals apartment buildings may be appropriate provided that their scale and massing, and articulation of detail, responds to the sites context.

## Deliver sense of place

VALP Policy Ref: BE2



The facade of this apartment building is articulated to create interest. Duplex units are provided at ground floor level to provide additional doors fronting onto and animating the street space



The block has been designed so that it evokes the repeated rhythm of a run of terraced houses

# 6. High quality and sustainable building design

## Addressing corners



Figure 6.6: Gable ends which incorporate windows provide overlooking

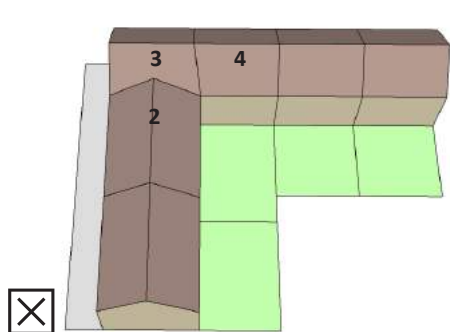

Figure 6.7: Linking houses together at a corner causes problems with garden space and privacy. Here the example shows there is no garden for houses 2, 3 and 4

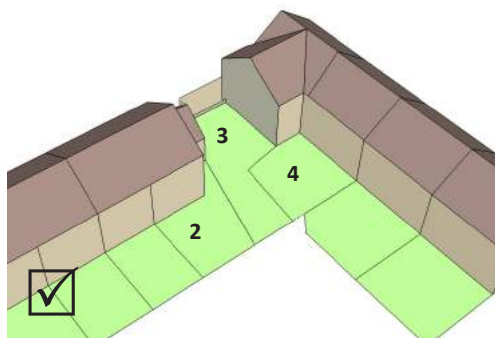

Figure 6.8: By extending plot 3 to turn the corner and setting back plot 2 it provides sufficient space for a garden. By providing plot 2 with a single storey element and an adjoining brick wall, it further assists with maintaining a built frontage

## Deliver sense of place

VALP Policy Ref: BE2



Entrance areas and windows “turn” the corner to provide overlooking to both streets



Marking a prominent street corner through building form



Development addresses corner poorly

### Principle DES39: Promote buildings that respond to and help to enclose and animate the street space

Development should be designed to ensure that urban streets and public spaces have good levels of natural surveillance from buildings. This can be achieved by ensuring that in urban areas, streets and spaces are overlooked by ground floor habitable rooms and upper floor windows.

Apartment buildings within town centre locations should generally have non-residential uses at ground floor level and these should be designed to provide an 'active' frontage to the street. The floor to ceiling height at ground floor level should be greater to allow flexibility on its future use.

Apartment buildings that do not incorporate ground floor non-residential uses should be designed to avoid bedrooms at the ground floor level overlooking the public realm as this can reduce privacy for residents and also reduce passive surveillance of the public realm. It is often more appropriate to incorporate duplex units on the ground and first floor of apartment buildings to avoid such scenarios.

#### Boundary treatments

In town or village centre locations or mews style developments, buildings may be located directly to the rear of the footway or public realm, but in most cases properties should have a boundary that defines public and private space including front gardens.

Boundary treatments should be reflective of the area and local traditions in terms of height, structure and materials. This should be drawn from the applicants Character Study (refer to Section 3.8).

Boundary treatments should not impair natural surveillance or wildlife movement.

For larger developments boundary treatments should be coordinated to contribute to the character of the street but allow for some variety and individuality.

#### Building entrances

Main entrances to houses, ground floor flats, communal entrances for flats and non residential uses should directly face onto the street and be clearly visible from the public realm.

All building entrances should be welcoming and easily identifiable to help improve legibility.

The scale and style of an entrance should relate to its function. The more important the function of the building, the more impressive the entrance should be. For example, a public building should have a larger and more prominent entrance than a house.

Recessed entrances or canopies integrated into the design of the building facade should be provided whilst avoiding creating areas that are hidden from view. Canopies should not appear to be 'bolt-on' solutions and instead make a positive contribution to the building facade.

For apartment buildings entrances to shared stair cores should be directly from the street and should be generously proportioned, well lit by natural light and naturally ventilated.

Ground floor dwellings within apartments should have individual entrances direct from the street. This increases the animation of the public realm and reduces the numbers of dwellings served by communal cores.

## 6. High quality and sustainable building design

### Overlooking the street

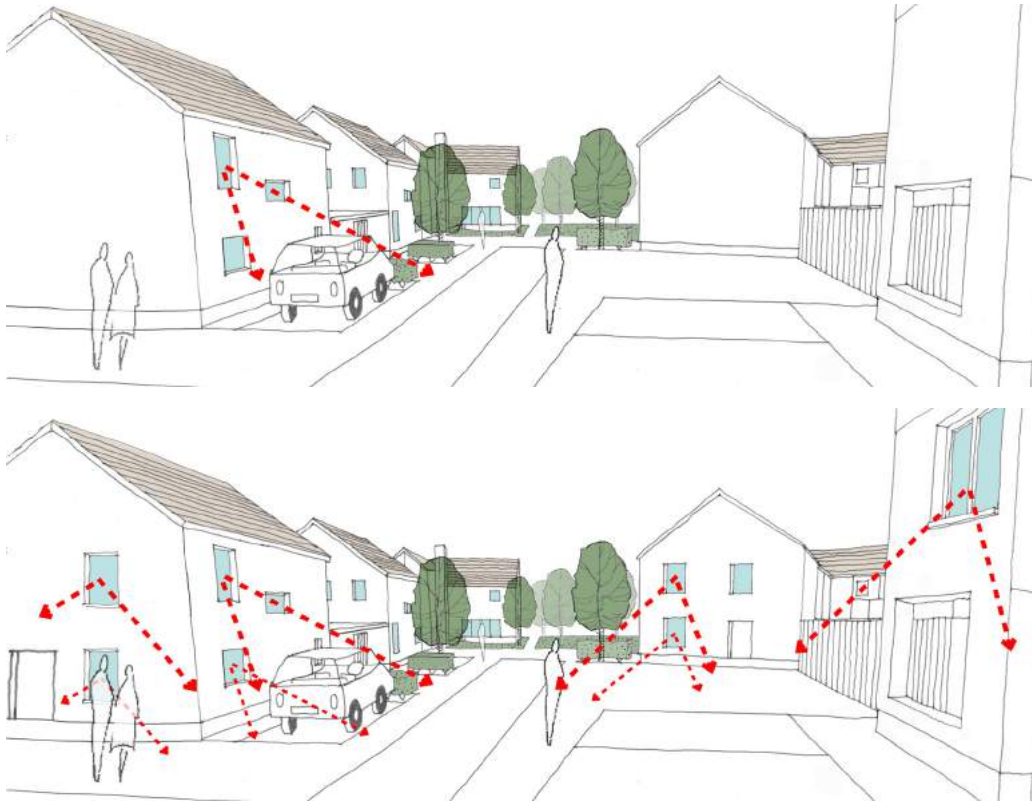

Figure 6.9: Ensuring that all public areas are overlooked by adjacent buildings, to increase 'eyes on the street' will reduce the likelihood of anti-social behaviour

## Deliver sense of place

VALP Policy Ref: BE2



Properties at the former Princess Mary's hospital site in Wendover provide good overlooking and definition of the street space



Buildings relate poorly to the street space providing a lack of animation or overlooking



Properties provide a discontinuous 'weak' frontage to a main street

# 6. High quality and sustainable building design

## Boundary treatments and building entrances

6.1.8 The interface of a property with the public realm should be clearly defined in a manner that responds to or complements that used in the local area. In some areas boundaries are predominantly defined using brick walls sometimes in combination with flint; in others the prevailing material is stone or witchert. Generally walls should have proper coping details and avoid 'brick on edge'. Native species hedging, estate railings or post and rail fences are also acceptable in rural areas.

6.1.9 Access gaps should be left to allow wildlife to move. For example, 13cm holes cut into wooden or concrete fences, holes dug under obstacles, or ramps used over low walls, allow hedgehogs to roam safely and breed successfully

6.1.10 Suburban types of boundaries including metal railings, reconstituted stone walls and brick walls in combination with timber fencing, can look out of place in a rural setting and should be avoided. Equally the use of timber knee rails and bollards should be avoided. Both should generally be unnecessary if a design is properly thought through.

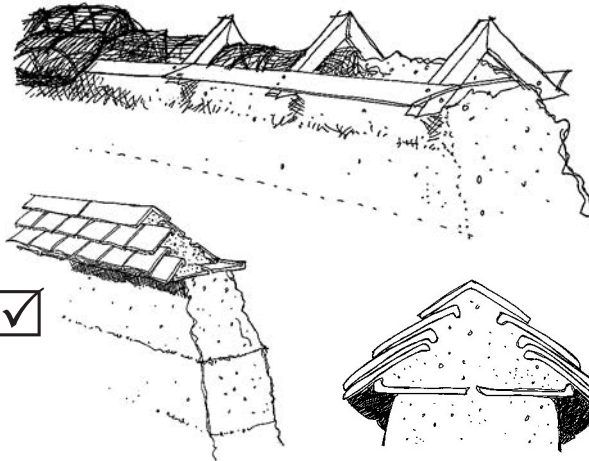

Wichert walls are characteristic of some parts of the area **CLOCKWISE FROM TOP:** Many witchert walls were originally thatched; arrangement of plain clay tiles to protect the material below; details of witchert wall construction which is built up in layers known as 'rises' of a naturally occurring mixture of clay mixed with chopped straw and a little water and chalk



Natural stone boundary walls are a characteristic feature in Aylesbury Vale

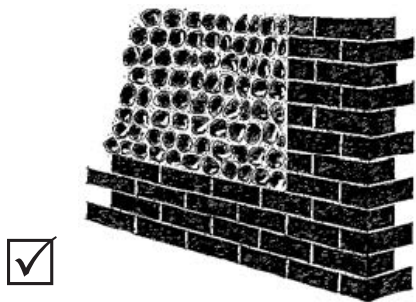

Flint panels within brick walls are attractive if lime mortar is used. Knapped and cobbled forms of flint construction are found in the area

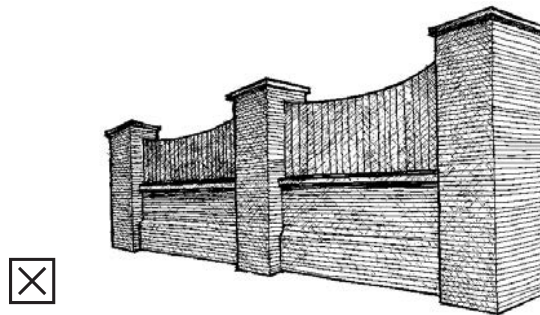

Suburban types of boundary are usually inappropriate in rural parts of the Vale

## Deliver sense of place

VALP Policy Ref: BE2



Wichert walling on this residential scheme in Haddenham defines property boundaries



Native hedging and estate railings create an attractive boundary to new homes in Dadford



Lack of a defined edge to the housing plots and poor quality timber knee rails diminish the quality of the street environment

# 6. High quality and sustainable building design

## Deliver sense of place

VALP Policy Ref: BE2

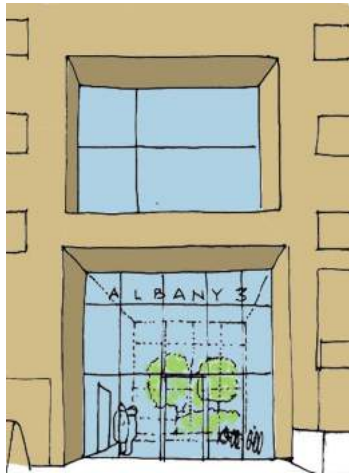

Figure 6.10: Entrances to important buildings, apartments and non-residential uses should be more civic in their appearance

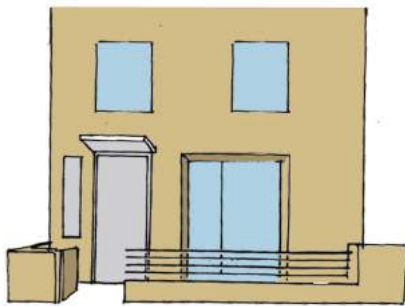

Figure 6.11: Entrances to dwellings should have a more domestic scale to them



Close board fencing should not be used at the street interface



Post and rail fencing is out of place except in rural areas



The interface of residential plots with the footways should be defined by a boundary that responds to the context



Defensible space provided at entrance to properties but materials lack robustness



The entrances to these residential blocks are not apparent from the street



Building entrances should be at street level, or slightly elevated but not below street level

### 6.2 Architectural integrity

#### Principle DES40: Promote buildings that have architectural integrity utilising high quality detailing and materials

Applicants should establish an architectural approach and identity borne from the place in the design of building.

The facade and elevational treatment, roofscape fenestration and materials used in existing buildings within the locality should be a starting point for the consideration of architectural design of new buildings. However this should not result in poor pastiche replicas that present a parody of traditional buildings. Instead a re-interpretation of key aspects of their form should be demonstrated; for instance, their symmetrical layout, window to wall ratio, and proportions and placement of windows and doors.

The architectural approach must consider

- Elevational treatment and façade design;
- A choice of window design that is determined by the overall design approach;
- A simple roofscape and form that creates a harmonious composition and minimises the visual impact of downpipes and guttering;
- Incorporation of dormer windows informed by the character and appearance of the local vernacular;
- A contemporary interpretation of traditional chimneys (where appropriate); and
- A context appropriate palette of good quality materials, with a preference for local materials and/or materials with low embodied energy. The durability and resistance to weathering of materials is an important consideration in selection.

#### Reason

6.2.1 New development in Aylesbury Vale must respond to the characteristics of the place. Applicants should refer to their Character Study (refer to Section 3.8) to understand distinctive features and characteristics of the area and re-interpret this in their proposals. It is particularly important to reflect the historic characteristics of conservation areas and other heritage assets within or in the context of the site in this background study.

6.2.2 It is recognised that the level of architectural detail provided as part of an Outline Planning Application will be less defined than as part of a Full Planning Application. For Outline Applications applicants will be required to provide architectural principles that will inform the building design with these further articulated through a design code. The level of detail required in the design code to be agreed with planning officers as part of pre-application discussions.



Contemporary waterfront development in Marsworth overlooking the Grand Union Canal



## 6. High quality and sustainable building design

### Facade and elevations

6.2.3 Applicants should refer to their Character Study (refer to Section 3.8) to consider the facade and elevational treatment of existing buildings within the locality and this should be a starting point for the consideration of elevational treatment and facade design for new buildings.

6.2.4 The area has a wide range of architectural styles and the arrangement of building facades varies however they are usually simply organised with windows and doors aligned both horizontally and vertically.

6.2.5 Applicants should avoid crowded façades and arrangements that are almost, but not quite, aligned.

6.2.6 Particular care must be taken with the:

- Choice of materials to respond to place and allow for future maintenance. Applicants should promote a consistent treatment to the front and rear facade and avoid the use of render;
- Design of balconies to ensure that they are integrated into the design and do not appear as 'bolt-on' or dominant features;
- Integration of rainwater downpipes;
- Location of meter boxes to ensure that they are inconspicuous

## Architectural integrity

VALP Policy Ref: BE2



Figure 6.12: Modern town house elevation takes inspiration from traditional patterns and proportions



Homes in Dadford use traditional materials in a simple and elegant manner

# 6. High quality and sustainable building design

## Windows

6.2.7 The choice of window design should be determined by the overall design approach. For example, a contemporary design may incorporate large glazed elevations, which would be inappropriate in a more traditional design. The number of window openings and their size can have a profound effect on the appearance of a building.

6.2.8 With careful design, windows can create a light and airy impression and make a building appear less bulky. However, if poorly designed, too many windows can make a building appear overly fussy and fail to respect the character of the area. It should also be noted that a greater window area will increase the energy demands of a building.

6.2.9 Buildings of traditional design should predominantly have rectangular windows, usually constructed of timber, with the emphasis on either the horizontal or vertical axis. Modern buildings can have a variety of window designs provided they are part of an overall design concept.

6.2.10 The positioning of windows, including sill and arch/lintel heights, needs careful consideration to ensure the design reflects the character of the area. In more traditional designs, the positioning of windows within their reveals is also important – windows that finish flush with the front face of a building can appear flat and uninteresting, whereas windows that are set back within reveals cast shadows which add visual interest. The degree of any window recess should also take into account the choice of facing material. For example, stone buildings can accommodate a deeper window recess than brick buildings.

6.2.11 Bay windows can be used to add interest to elevations and create attractive features on buildings.

6.2.12 UPVC windows are less successful in design terms, particularly in traditional buildings and historic settings due to their bulky frames and glazing bars. Wherever possible, timber should be used unless an alternative material is shown to be more appropriate.

## Architectural integrity

VALP Policy Ref: BE2

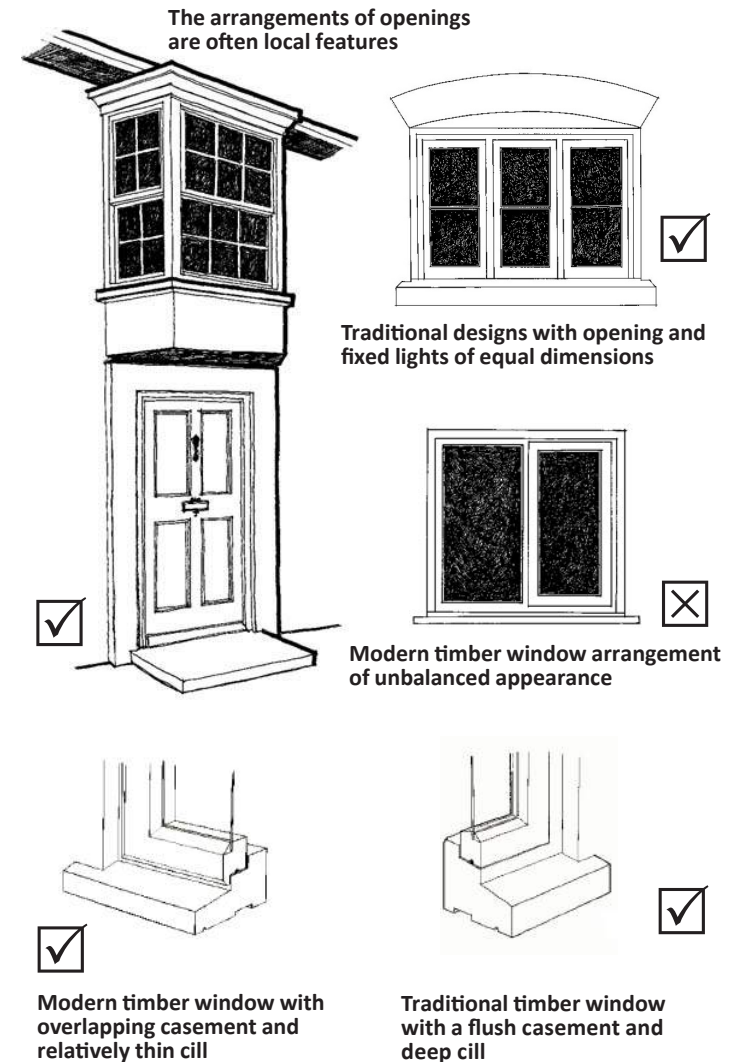

Figure 6.13: Traditional window arrangements

## 6. High quality and sustainable building design

### Roofscape

6.2.13 The pitch and form of roofs and the roofscape within a settlement are important to the character of the place.

6.2.14 Applicants should refer to their Character Study (refer to Section 3.8) to consider the prevailing roofscape within the locality.

6.2.15 In Aylesbury Vale, the use of steep dual pitched roofs in clay plain tiles is predominant on older buildings. Slate and clay pantiles are also widespread roof materials. There are also a considerable number of thatched buildings. New development should respect these simple characteristics.

6.2.16 Plain clay tiles are preferred for roofs, where roofs are hipped, then bonnet hip tiles are preferred for hip ridges as this gives a complete and harmonious appearance to the roof as a whole. "Handmade", that is, irregular clay tiles which match earlier products, may be required for Listed Buildings or in Conservation Areas. Machine made clay tiles are generally less suitable than "handmade", but these are preferred to concrete tiles. Plain tiles are always preferable to concrete interlocking tiles by virtue of their size and lapped arrangement.

6.2.17 Materials used for roofs are associated with different roof pitches (refer to Section 3.7). Where there is a prevalent angle of pitch within a settlement this can be a powerful contributor to the character of the area. Applicants should consider if this is the case and whether this should be reflected within their proposals.

6.2.18 Proposals should avoid shallow pitched roof profiles or inconsistent roof angles juxtaposed towards each other.

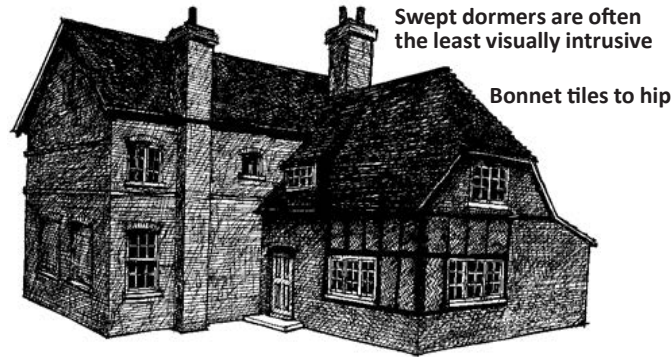

Steep pitched roofs in clay tiles complement the Vale's rural character

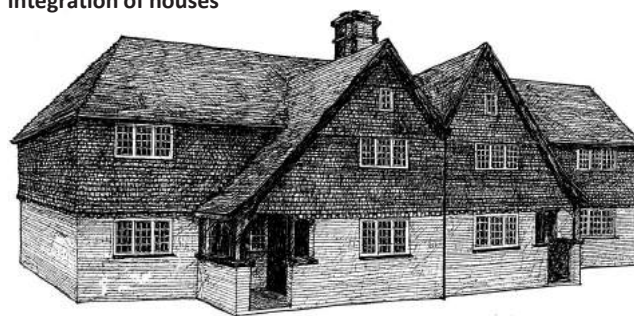
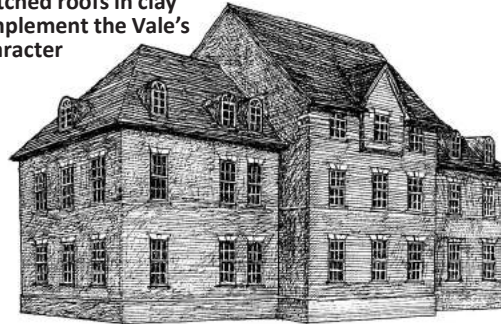

Figure 6.14: Local roof characteristics

## Architectural integrity

VALP Policy Ref: BE2



## 6. High quality and sustainable building design

### Chimneys

6.2.19 Chimneys are a traditional feature within Aylesbury Vale which contribute to the character of the area. Developments are encouraged to include chimneys as they can contribute to the overall appearance of a development.

6.2.20 Chimneys or stack features can be used in modern ways such as for thermal stacks to aid ventilation in summer, to incorporate flues from wood burning stoves or as a service core for gas flues or vent outlets.

6.2.21 Chimneys can be located in a number of positions including:

- On the gable end or projecting from the gable end, usually at first or sometimes second floor level;
- Along a side or rear wall or occasionally on the front;
- Within the gable end;
- Along the ridge;
- Projecting from the roof plane away from the ridge; or
- A central position within the building optimises energy efficiency as there is less heat loss than if located on an external wall.

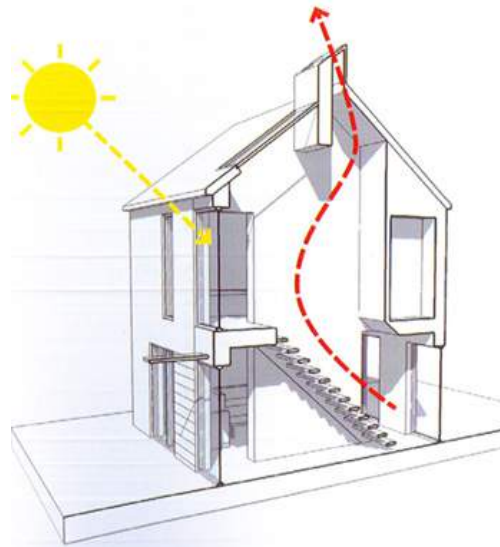

Figure 6.15: Contemporary chimney designed to provide ventilation but also articulate the roofline

### Dormers and rooflights

6.2.22 Dormer windows can be prominent traditional features in the streetscene. However, care needs to be taken with their design, proportions and position on the roof. Large horizontally proportioned dormers appear top heavy and alien to traditional form.

6.2.23 The choice of design should be informed by the character and appearance of the local vernacular.

6.2.24 Dormers should be positioned so that they line up with openings on the main façade.

6.2.25 Rooflights may be a discordant element on new houses unless they are small, positioned out of public view or used sparingly. Flush fitting rooflights, that use non-reflective glass can reduce the visual impact of roof openings.

## Architectural integrity

VALP Policy Ref: BE2



Dormers can be used in new development to reflect local vernacular in a modern way. Avoid dormers that are out of proportion with the facade

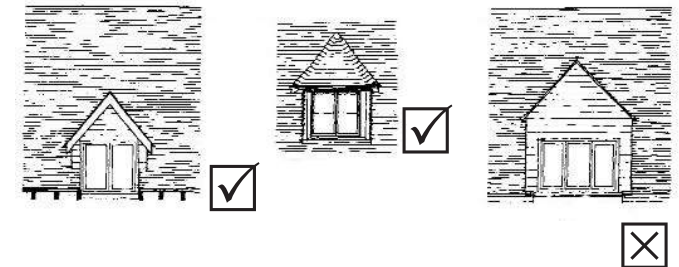

Large dormers give a 'top heavy' appearance

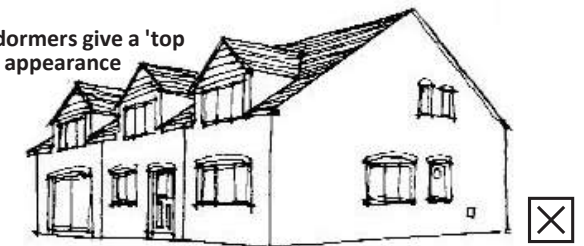

Figure 6.16: Dormers are an acceptable feature on the roofscape but must be carefully positioned and proportioned so that they do not dominate or unbalance the architectural composition

# 6. High quality and sustainable building design

## Garages

6.2.26 The front door is traditionally the main feature of a house, a point of focus and entry. Garage doors can however be the largest single element on a house elevation and when inappropriately located can over dominate and create an impression of the dwelling being subordinate.

6.2.27 Garages must be carefully sited and proportioned so that they are subordinate to the main dwelling and not visually prominent.

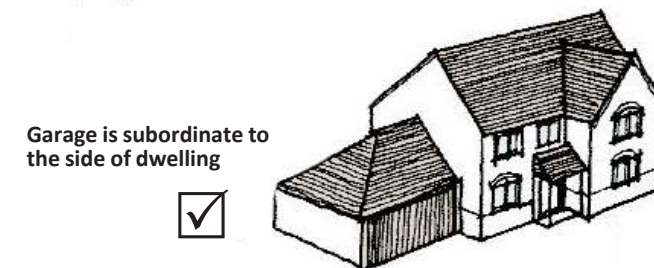
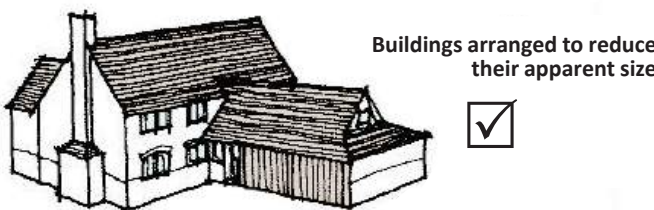
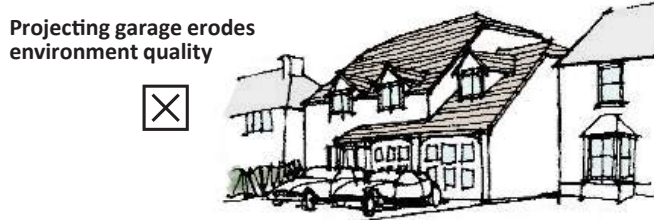
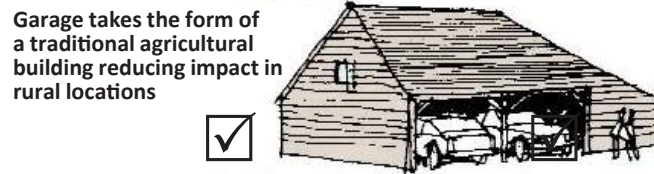

# Architectural integrity

VALP Policy Ref: BE2

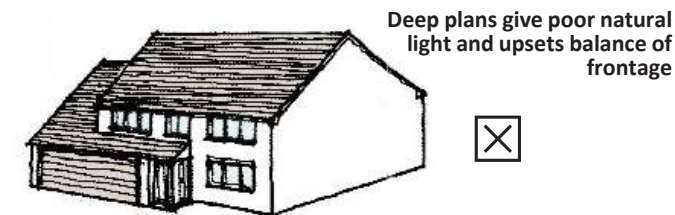
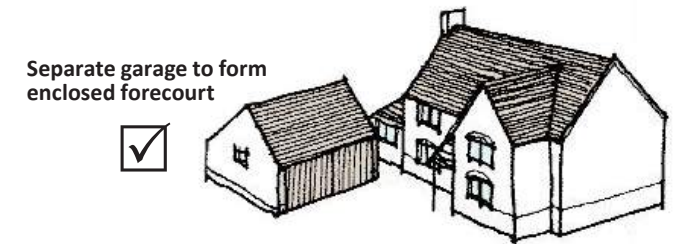

Figure 6.17: The design of garages and their relationship with a dwelling must be carefully considered

# 6. High quality and sustainable building design

## Materials

6.2.28 Whilst architectural style varies within the area a prevailing characteristic of most successful buildings is a simple, restrained palette of materials, detailing and architectural features integral to the design.

6.2.29 The choice of materials and architectural features in new development is often overly complicated, pastiche or includes 'bolt-on' elements that are out of place.

6.2.30 The choice of materials and detailing should be drawn from the local context and re-interpreted if a contemporary approach is taken.

6.2.31 Materials should reflect the character of the area and also the style of architecture adopted. For instance, for a traditional architectural approach use the materials that are used within the area (e.g. for roofs normally plain clay tiles or slates) where as if a contemporary approach is taken there is potential to explore a wider range of materials (e.g. zinc / copper roofing).

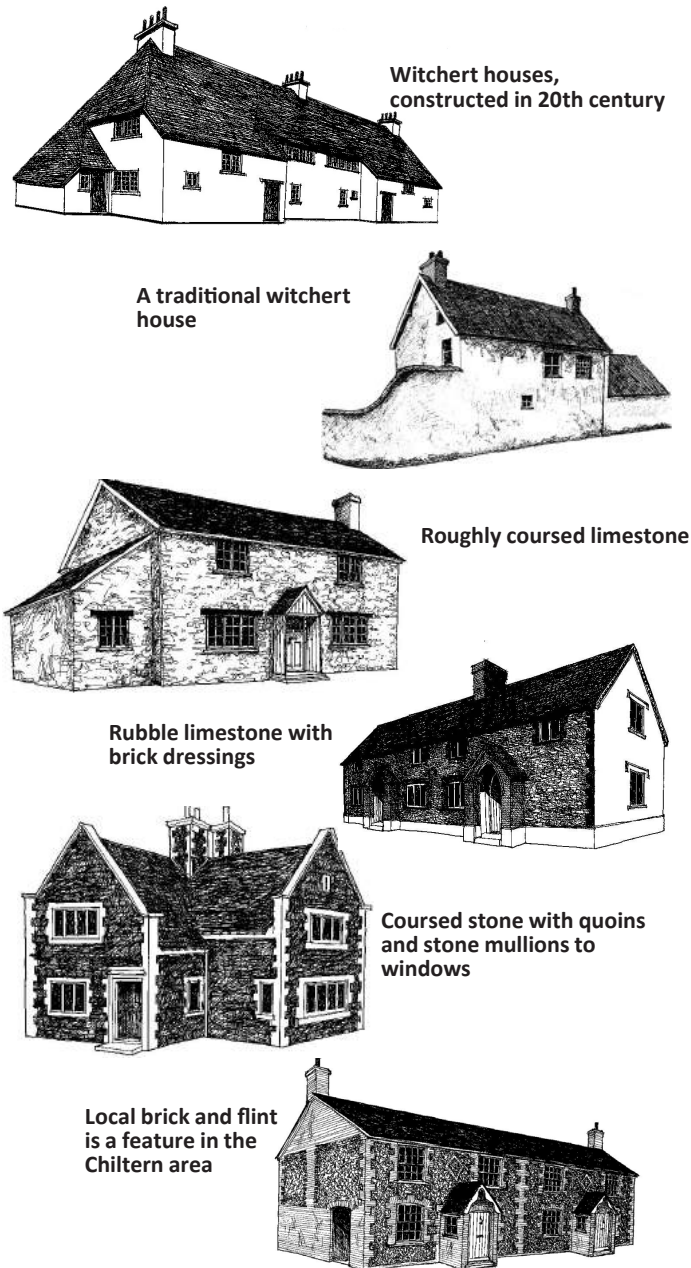
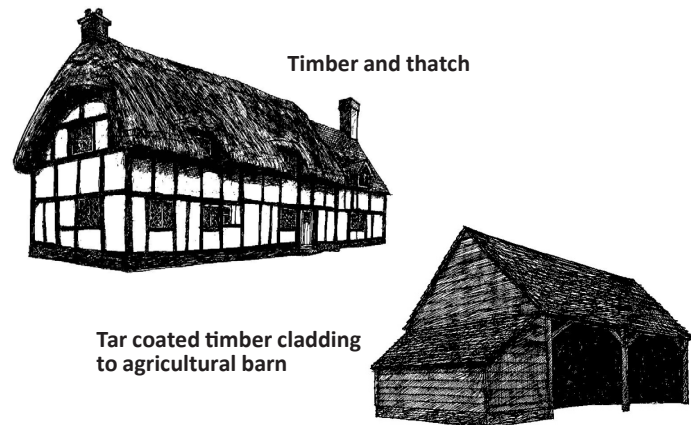

Figure 6.18: Buildings are constructed in a wide range of traditional materials in Aylesbury Vale - this is reflective of their location

# Architectural integrity

VALP Policy Ref: BE2

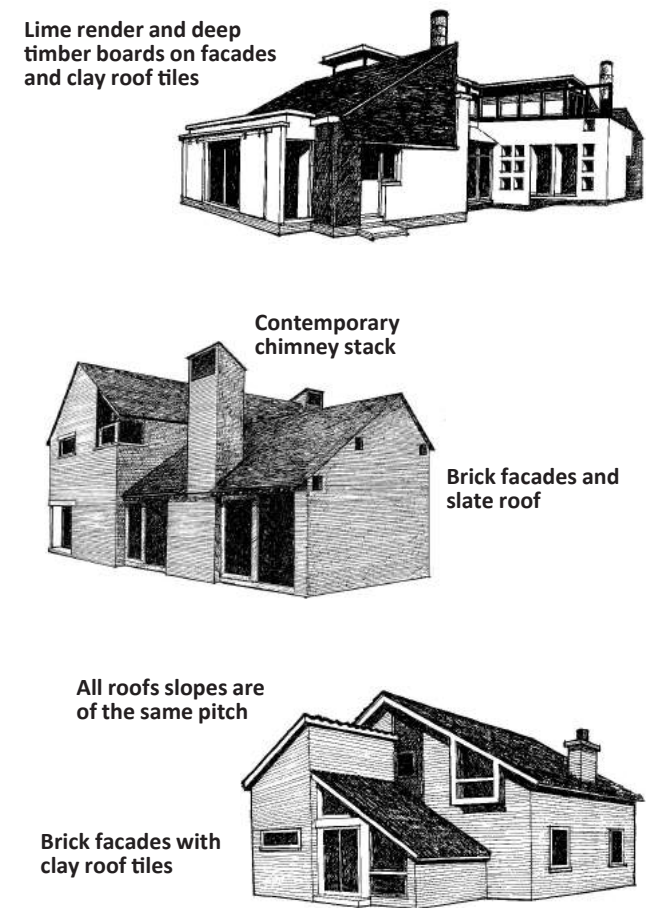

Figure 6.19: Contemporary buildings using traditional materials

## 6. High quality and sustainable building design

### Principle DES41: Consider the location and design of utility meters and rainwater goods so that they don't adversely impact the quality of development

Utility meters should be carefully planned for so that they are both conveniently located and unobtrusive.

Enclosures for utility services and meters must not dominate the building frontage and solutions must be harmonious with the overall architectural design of the property.

Wherever possible, rainwater goods, external service pipes and other apparatus should be grouped together and discretely located on elevations which are not prominent. This requires careful consideration of the provision of all services at the initial design stage. Service routes beyond properties should be carefully planned so that they do not impact on existing trees or the potential for new trees. Refer also to Principle DES32.

Apartment buildings should always have a communal aerial and satellite dish if cable TV is not available, and a condition should be attached to the planning permission to this effect.

### Reason

6.2.32 The apparatus of modern services (e.g. external pipework, flues, vents, meter cupboards, satellite dishes and aerials) can create a cluttered appearance and detract from the design of an otherwise successful development. Careful consideration, therefore, needs to be given to their location, materials and integration on buildings.

## Architectural integrity

VALP Policy Ref: BE2



Rain water pipes have been positively accommodated using high quality materials



Waste pipes are prominent on the gable facing the street



Meter boxes are prominent on building frontages

# 6. High quality and sustainable building design

## Residential amenity

VALP Policy Ref: BE2; BE3

### 6.3 Residential amenity and privacy

#### Principle DES42: New development must be designed to respect the privacy of existing residents

Applicants will need to demonstrate how privacy will be maintained between new and existing development whilst designing to the principles of compact neighbourhoods in more urban locations.

The relationship of buildings to each other, their height and the positioning of windows and the provision of good noise insulation can all have an impact on the privacy enjoyed by neighbouring properties. When providing more compact development applicants may consider positioning of windows or arrangement of habitable rooms to reduce direct views. This must also take account of changes of level / topography.

The use of set back upper floors, recessed balconies and internal courtyards can all help to deliver higher densities whilst respecting privacy.

Direct overlooking of private amenity space by habitable rooms in neighbouring properties should be avoided.

#### Reason

6.3.1 It is important that all residents are able to feel comfortable in their own home and an adequate level of privacy is required to assist this.



Planting can help to increase privacy



Windows are angled to look away from properties



Recessed balconies provide additional privacy to the rooms that open onto them

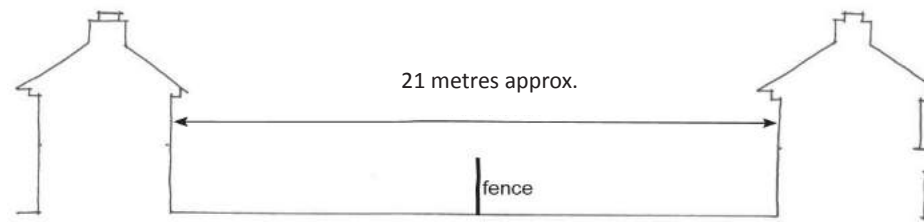

Figure 6.20: An adequate distance between facing habitable rooms helps enable people to feel comfortable in their own homes. Sometimes, through creative design, it is possible to reduce the back to back distances with other measures to avoid overlooking.



## 6. High quality and sustainable building design

### Principle DES43: Provide attractive and usable external amenity space for all homes

All dwellings should have access to private outdoor amenity space. This open space should be appropriate to both the location of the proposal and the type and size of accommodation and it should be located where it is not subject to continuous overshadowing.

Amenity space should be provided in the form of a private garden, patio, balcony or communal garden depending on the type of dwellings being provided. Private gardens should be treated as an extension of the living space of the house.

Communal gardens should be incorporated to the rear of blocks to provide visual amenity and outdoor space for residents. Soft landscaping should be prioritised over areas of hard standing and consideration should be given to provision of outdoor seating, eating, drying and growing space.

External access to gardens should be provided to allow for maintenance and removal of garden waste without passing through a property. Long, narrow alleyways should be avoided.

Increasing structural diversity by retaining and creating buffer areas of woodlands, species rich grassland, ponds or native plant hedgerows can all encourage wildlife.

Wildlife-friendly gardening and climate-resilient native species planting should be promoted. Bird and bat boxes, bee bricks and dead wood can create additional habitat. Native plants and wildlife also enhance soil fertility, increase pollination, and provide natural pest management.

Creating microclimates can protect gardens from climate-related weather extremes. Microclimates can be built throughout by taking advantage of retained natural features like shade trees, rocks, ponds and slopes.

Ground floor homes in apartment blocks should have access to a well defined, rear, private area. This will act as 'defensible space' and create good quality amenity.

Residents living in upper floor apartments should have access to outdoor spaces, which could include a balcony which is large enough to be enjoyed and a communal space to do activities not facilitated by balconies. Balconies should be positioned to ensure they do not cause overlooking of neighbouring properties.

## Residential amenity

VALP Policy Ref: BE2; BE3



Private and communal gardens provide opportunity for communities to come together

### Reason

6.3.2 Providing private amenity space in the form of garden space, balconies or communal gardens is important in achieving a successful and attractive development.

## 6. High quality and sustainable building design

## Residential amenity

VALP Policy Ref: BE2; BE3

### Principle DES44: Homes should be designed to receive adequate daylight and sunlight and to avoid overshadowing

All properties must have access to adequate daylight and sunlight. Single aspect north facing apartments should be avoided as they do not gain direct light and single aspect south facing apartments are not generally welcomed as they are subject to overheating.

Within higher density developments care should be taken to avoid areas which are permanently in shade or overshadowed by adjacent buildings.

Buildings close to the boundary of neighbouring properties can increase overshadowing or loss of daylight to neighbouring properties.

### Principle DES45: Design to minimise the impacts of noise, air and light pollution

Disturbance from noise, light sources and the impacts of poor air quality can be reduced through careful design. The following techniques can be used:

- Orientate buildings so that habitable rooms and sitting out areas do not face noise and light sources;
- Locate amenity areas including gardens, communal gardens, play areas and balconies away from areas of poor air quality;
- Introduce design features such as recessed balconies, acoustic lobbies and winter gardens;
- Construct barriers such as garages or walls between noise sources and dwellings;
- Use landscape to absorb noise and to improve air quality; and
- Locate noisy external activities such as play areas close enough to the properties they serve to be safe and usable but far enough way to avoid noise disturbance.

### Reason

6.3.3 Noise can be a source of significant aggravation for residents, particularly at night. Issues associated with noise are particularly prevalent in locations close to external sources of noise such as railway lines and busy roads.

6.3.4 Air pollution is associated with a number of adverse health impacts; it is recognised as a contributing factor in the onset of heart disease and cancer. It particularly affects the most vulnerable in society: children and older people, and those with heart and lung conditions. Development must therefore be designed to minimise exposure to areas of poor air quality and to explore opportunities to mitigate the impacts through for instance planting.

# 6. High quality and sustainable building design

## Commercial buildings

VALP Policy Ref: BE2; E1; E2; E3

### 6.4 Commercial buildings

#### Principle DES46: Commercial buildings

Employment buildings should respond positively to the character and architectural traditions of the area in terms of scale, mass, form, materials and detailing.

Within town centres offices must present a positive interface with the street with entrances prominent and helping to animate the street space.

On business parks and industrial estates as a general principle, the landscape and public realm should form the dominant feature within employment areas with the buildings forming a more neutral background. As such, the design of simple, rectilinear buildings within the landscape is promoted. Planting schemes for these areas should favour locally appropriate native species.

The design of commercial buildings must consider:

- Articulation of the ground floor of buildings to create a more human scale;
- More generous floor to ceiling heights typically between 4.0 and 4.5 metres;
- Consideration of building materials that are responsive to place. Where buildings are located within the countryside, materials should be in muted tones so that buildings blend in to the surrounding environment. Highly reflective materials should be avoided;

- The design of building entrances so that they are generous and welcoming, include covered areas and are easily identifiable to help improve legibility and provide protection from the weather;
- The location of reception areas and office space so that it positively contributes to the surveillance of entrance areas and forecourts; and
- The location and coordination of signage to minimise its impact and ensure that signage on buildings is not overbearing on the streetscape or out of proportion with the scale of buildings.

Whilst it is accepted that some employment buildings will be of a significant scale, applicants should consider the impact of these buildings on views from the countryside and the wider context. Measures to mitigate their impact should be considered. For example, low profile pitches / barrel vault roofs may be preferable to angular flat roofs. Green roofs should be considered where appropriate.



#### Reason

6.4.1 Well designed commercial buildings that are designed to respond to place and to animate and address streets will contribute to more attractive environment for people working in Aylesbury Vale and also to the image and perception of the place as a location to establish new businesses or relocate to. This could have significant economic benefits for the area.

# 6. High quality and sustainable building design

## 6.5 Sustainable buildings

### Principle DES47: Minimise environmental impact by energy efficient and sustainable design

Sustainability must be considered throughout the design process for all proposed developments, including retrofits and extensions, employing appropriate technology in energy generation, renewables, and low carbon energy. This should include use of sustainable materials.

Consideration should be given to retaining and retrofitting existing buildings to retain embodied carbon.

Developments are encouraged to achieve high sustainability standards appropriate to the type of development including BREEAM 'Excellent' Standard and to utilise Modern Methods of Construction.

Electric vehicle infrastructure within all new developments should be provided in accordance with the latest standards, with consideration given to future requirements for the technology.

Applicants must demonstrate how sustainability has informed their design which should consider orientation and design of buildings to maximise daylight and sun penetration, whilst also avoiding overheating, and the use of:

- Green roofs or walls to reduce storm water run-off, increase soundproofing and biodiversity;
- Materials with low embodied energy or recycled materials (for example re-use of existing concrete as road fill or in foundations);
- Materials with a high thermal mass, such as stone or brick, which store heat and release it slowly;
- Photovoltaics or solar thermal water heating;
- Water efficiency;
- Ground, water or air source heat pumps for heating; and
- Low flow technology in water fittings, rainwater harvesting systems and grey water recycling systems to reduce water consumption.

## Sustainable buildings

VALP Policy Ref: C3; T7



Carbon neutral homes at Bedzed

### Reason

6.5.1 The increasing realisation of the climate emergency means that the government is now committed to reaching net zero carbon emissions by 2050. Investing in and implementing sustainable design practices will help to work towards climate mitigation, whilst improving economic growth and creating healthier communities.

6.5.2 It is recognised that careful consideration must be given to retrofit and renovation of historic buildings. Historic England has prepared a range of advice on how to reduce carbon emissions and improve energy efficiency and performance in traditional properties. Applicants should refer to this material when preparing their proposals.

6.5.3 The council's aspiration to deliver sustainable development and a resilient future should be reflected in all applicants' proposals.

## Principle DES48: Living roofs and walls

Living roofs and walls should be considered to improve sustainability of buildings: through managing water run-off, conserving and enhancing biodiversity in urban areas, increasing energy efficiency and visually integrating buildings into rural surroundings. Living roofs should be considered when proposing flat or shallow pitched roofs, including garages and extensions to buildings.

Careful consideration should be given to position, form and design, setting clear objectives to determine the best type of living roof or wall. Appropriate species selection and understanding and meeting maintenance objectives are vital for success.

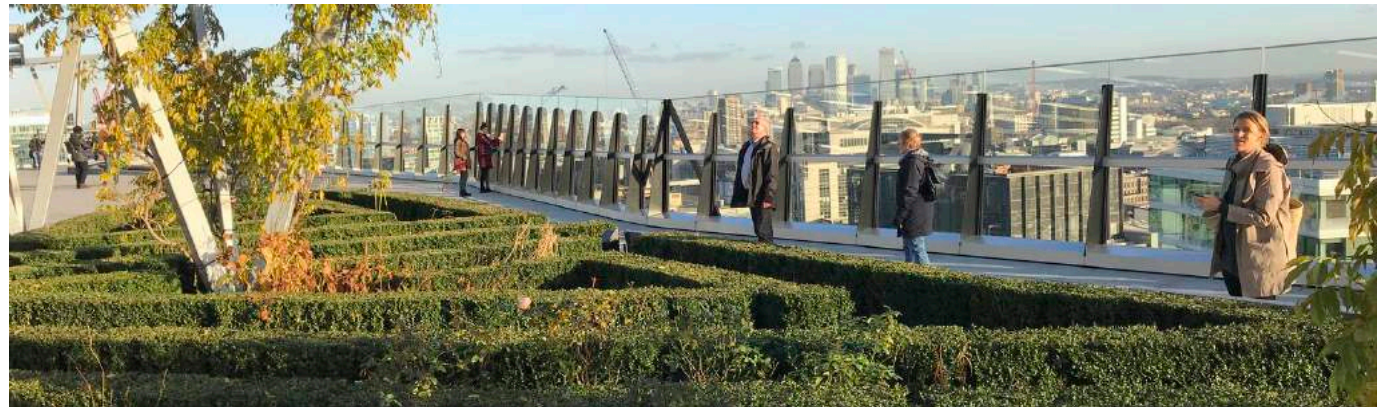

A living roof on a building in central London (image LUC)

### Reason

6.5.4 Living roofs and walls are vegetated roofs and walls. Living roofs can take differing forms in order to maximise their benefits in a given location. Living roofs can be 'green' when a planting scheme is established on a roof structure, or 'blue' when the aim is to control and reduce rainwater run-off.

6.5.5 The main benefits include:

- Rainwater attenuation;
- Provision of wildlife habitat;
- Energy savings;
- Visual and landscape benefits;
- Improved air and water quality;
- Quieter buildings;
- Space for food production; and
- Reduced costs, including drainage, heating, air conditioning.

6.5.6 Living roofs can play an important role in the sustainable management of rainfall and surface run-off reducing the flow of water to the conventional sewer system, as part of a Sustainable Drainage System (SuDS). Their ability to retain water and slowly release it back to the system is an efficient method of source control. Light rainfall events (5mm or less) are normally completely absorbed by a green roof. Thorough waterproofing is a key consideration.

6.5.7 Living roofs and walls can also provide increased biodiversity, particularly within urban areas, forming part of the green infrastructure network and improving connectivity, further integrating habitats. With incoming requirements for Biodiversity Net Gain, biodiverse green roofs and species-rich green walls are increasingly being used in urban areas to recreate habitat lost by development. As habitats on buildings tend to be isolated from ground level habitats, the most important wildlife associated with living roofs and walls tend to be invertebrates, birds and bats.

6.5.8 Conventional roofing surfaces absorb sunlight and release radiation back into the atmosphere, further contributing to the urban heat island effect. A building that has poor insulation and poor ventilation can also lead to increased use of air conditioning and therefore increased energy use. The many layers of living roofs and walls and evaporation of water from soil surfaces and leaves can bring the dual benefit of limiting the impact of climate change by keeping areas cooler while at the same time reducing energy use and carbon dioxide emissions.



A bio-diverse (brown) extensive roof

### Intensive and extensive roofs

6.5.9 Green roofs can be broadly broken down into intensive or extensive systems.

6.5.10 Intensive systems are generally used as recreational spaces and often include similar features to traditional parks and gardens such as shrubs, trees, paving, lawns and even water features.

6.5.11 Extensive green roofs generally provide greater biodiversity interest than intensive roofs, but are less appropriate in providing amenity and recreation benefits. Extensive green roofs designed specifically to create habitats for plants and animals are known as biodiverse (or brown) roofs. They typically combine wildflower and meadow type vegetation with varied substrate topography and materials.

Roof type	Extensive	Intensive
<b>Use</b>	Ecological landscape	Garden / park
<b>Type of vegetation</b>	Mosses, Herbs, Grasses	Lawn, perennials, shrubs, trees
<b>Benefits</b>	Water, thermal, biodiversity	Water, thermal, biodiversity, amenity
<b>Accessibility</b>	Not generally designed for public access	Can be designed for limited or full public access or high visibility
<b>Substrate depth</b>	60 – 200mm	150mm up to 1000mm
<b>Weight</b>	50-250 kg / m <sup>2</sup>	>150 kg/m <sup>2</sup> up to 2000 kg/m <sup>2</sup>
<b>Maintenance costs</b>	Low (1-3 visits per year)	High (regular visits)

Figure 6.21: Table indicating the differences between extensive and intensive living roofs

## 6. High quality and sustainable building design

6.5.12 Photovoltaic (PV) panels can be combined with green roofs and both systems will function as they should if designed correctly. Key issues to consider are spacing of the PV arrays, selection of shade tolerant plants and regular maintenance. These roofs are named 'solar' green roofs, if the PV panels are mounted on the green roof system or 'biosolar roofs' if the PV are integrated.

### Living walls

6.5.13 Living walls are those covered in some form of vegetation. Whereas roofs are not always a visible feature, living walls can become a major design feature, in addition to providing benefits for biodiversity, thermal efficiency and amelioration of pollutants.

6.5.14 Living walls can be separated into a number of categories:

- Supported by a wall e.g., self-supporting climbers;
- Supported by a structure on a wall e.g., trellis;
- Supported by a self-standing structure away from a wall;
- Hanging walls; and
- Walls with plants growing within them.

6.5.15 Living roofs and walls require appropriate levels of daylight, moisture, drainage, aeration to the plant's root systems, nutrients and maintenance. It is vital to know if the usual growing conditions of each species are comparable to the ones on the roof or wall to ensure their ability to adapt and flourish, as climatic conditions can often be extreme.

6.5.16 Well designed and constructed living roofs and walls will require structural engineers to calculate loading capacity of the roof, the heating and cooling implications and to integrate existing and proposed mechanical equipment and drainage needs. Landscape architects will be needed to design the layout of the planting areas and specify the planting. Health and safety consultants can advise on maintenance issues. Further design guidance can be sourced from the Green Roof Code of Best Practice incorporating Blue Roofs and BioSolar Applications.

## Sustainable buildings

VALP Policy Ref: C3; I1

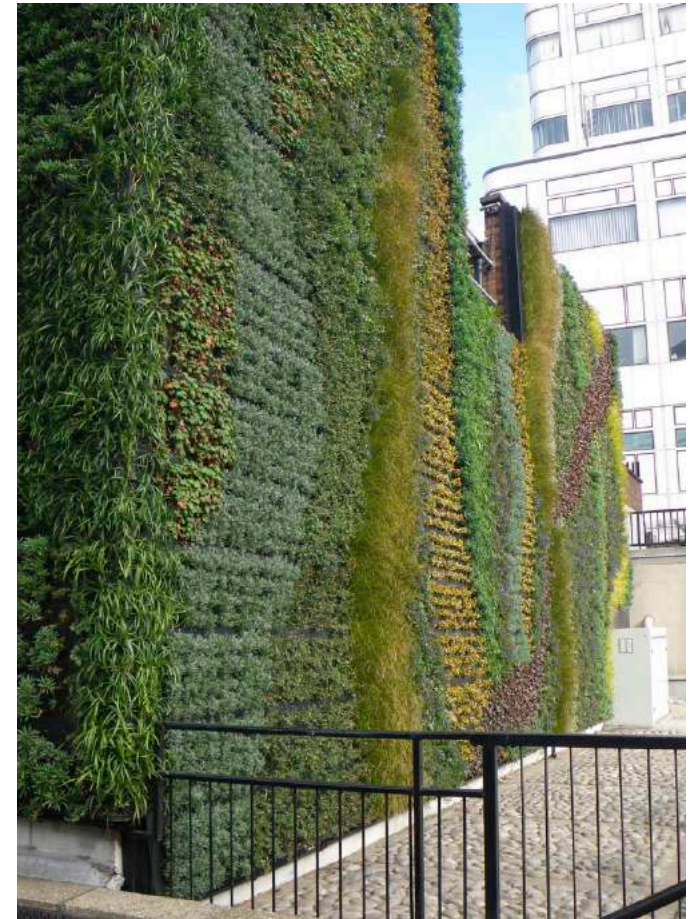

Living wall (image LUC)

## 6. High quality and sustainable building design

### Principle DES49: Sustainable building materials

Applicants should consider the use of sustainable materials to reduce the impact on the environment and provide a long-term durable solution for the built environment. This can range from technical solutions (for example, carbon fibre reinforced cement, lime mortars, wool insulation, recycled plastics, breathable paint) to socio-technical and economic (life cycle analysis and supply chain specification).

Developments should look to minimise construction waste, reuse and recycle. Locally sourced materials should be used, both reinforcing local character and reducing transport related impacts.

Materials which have a high thermal mass, such as brick and stone, are preferable, as well as the need for providing high levels of insulation.

Alongside sustainable building materials, sustainable building design, which allows for passive heating and cooling, is encouraged, see Principle DES47: Minimise environmental impact by energy efficient and sustainable design.

### Reason

6.5.17 Sustainable buildings materials are those considered to not deplete non-renewable (natural) resources and to have no adverse impact on the environment when used. The following principles should be followed to preserve natural resources and reduce the impacts of the materials used in development.

6.5.18 Preserve natural resources by:

- Avoiding use of scarce (non-renewable) materials, such as weathered limestone.
- Creating less waste.
- Using less; by not over-specifying performance requirements, by designing minimum weight structures and by matching demand to supply (such as balancing cut and fill).
- Using reclaimed, rather than new materials.
- Using renewable materials (crops, such as thatching roofs, which also reinforces local vernacular).

6.5.19 The impact of materials can be reduced by:

- Using materials with low embodied energy.
- Reducing transport of materials and associated fuel, emissions and road congestion.
- Preventing waste going to landfill.
- Designing and constructing for ease of reuse and recycling at end-of-life (design for deconstruction).

## Sustainable buildings

VALP Policy Ref: C3



A home being thatched in Granborough in the Vale

6.5.20 Constructing with sustainable materials is better for the environment, can save money in the long term, help preserve our heritage, respond to planning policies and meet building standard requirements, such as BREEAM. Applicants are encouraged to use recycled materials or materials with a low-embodied energy. The full life-span of materials should also be considered, including their re-use potential once their purpose has been served.

6.5.21 Wherever possible, materials with a high thermal mass and which reflect the local character of the area should be used.



## 6. High quality and sustainable building design

### Principle DES50: Local energy production

Applicants should integrate energy efficient solutions and renewable energy production into developments.

All development in Aylesbury Vale should be designed to reduce greenhouse gas emissions. This is promoted through an energy hierarchy that identifies the order in which energy issues should be addressed as set out in VALP.

Renewable energy is encouraged, however it should be designed and implemented taking into consideration impacts on:

- Landscape and biodiversity;
- Views;
- Historic environment;
- Green belt, particularly sense of openness;
- Aviation;
- Highways and access;
- Residential amenity; and
- Land use and agricultural quality.

### Reason

6.5.22 Local energy production is essential for the building of resilient and sustainable communities, through methods which help to economically boost the area. Masterplanning should be undertaken in such a way as to optimise the sustainability of the development as a whole taking account of wider infrastructure, orientation of buildings and other issues.

6.5.23 Renewable energy technologies should be integrated with the design of a building from the outset and designed to be sympathetic to the context of the building, landscape and/ or heritage.

6.5.24 For residential developments over 100 dwellings, the feasibility for district heating via combined heat and power technologies should be explored and evaluated.

6.5.25 Sustainable construction issues should be included in pre-application discussions. Where a sustainable construction assessment of a proposed development is required, an assessor should be engaged at the earliest possible stage to provide the best balance between maximising the sustainability potential of the development and minimising costs.

## Sustainable buildings

VALP Policy Ref: C3



Solar panels at Brooks Mews, Aylesbury

## Principle DES51: Reducing water demand

Applicants should take steps to reduce water demand, waste and enhance efficiency. Water recycling, rainwater harvesting, and efficient appliances are all methods of achieving this. Refer also to Principle DES47: Minimise environmental impact through energy efficient and sustainable design and Principle DES48: Living roofs and walls.

Applicants should consult with either Anglian or Thames Water (whichever applies) to understand the position on water resources, with an overarching aim to reducing mains water consumption.

Development must be designed to be water efficient and reduce water consumption. Refurbishments and other non-domestic development will be expected to meet BREEM water-efficiency credits. Residential development must not exceed a maximum water use as set out in Building Regulations.

Where possible, the council encourages solutions for rainwater re-use to be explored as a priority before drainage solutions are then considered.

The Local Planning Authority will seek to ensure that there is adequate water and wastewater infrastructure to serve all new developments. Developers are encouraged to contact the water/waste water company as early as possible to discuss their development proposals and intended delivery programme to assist with identifying any potential water and wastewater network reinforcement requirements. Where there is a capacity constraint the Local Planning Authority will, where appropriate, apply phasing conditions to any approval to ensure that any necessary infrastructure upgrades are delivered ahead of the occupation of the relevant phase of development.

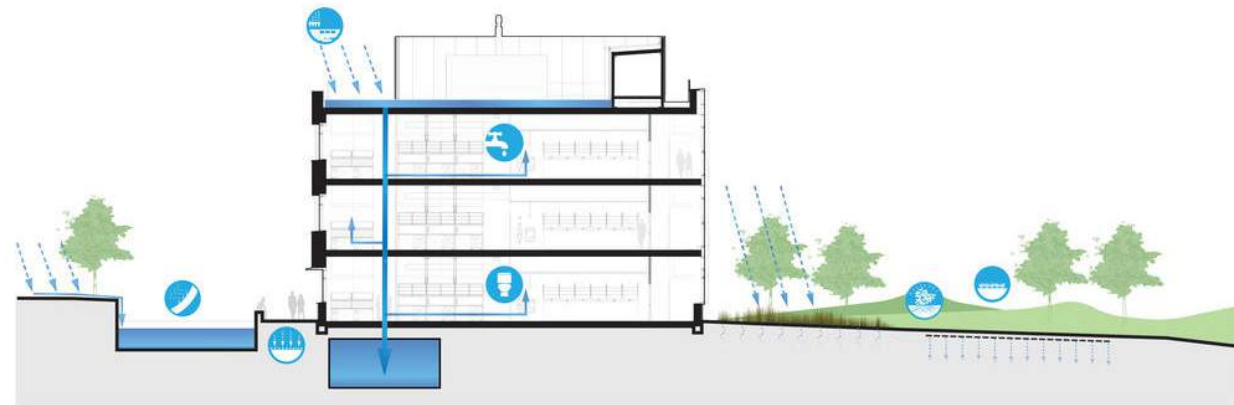

Figure 6.22: Water cycle strategy

### Reason

6.5.26 Aylesbury Vale sits within an area of water stress, and therefore high levels of water efficiency should be implemented and retrofitted into development, to provide adaptive measures to climate change.

6.5.27 VALP policy I5 requires all new homes to be built to the higher standard of water efficiency and re-use set out in the Building Regulations, which sets a maximum consumption of 110 litres per person per day.

# 6. High quality and sustainable building design

## Checklist

### How to use

This table provides a checklist for use by both the applicant and planning officer to check that appropriate consideration has been given to the design of buildings within a proposal.

**PROCESS:** Have you read, understood and applied the principles set out above?

The adjacent table summarises the key principles set out within this section and can be used by applicant and officer as a checklist.

**Applicants will be expected to demonstrate to the council that they have responded adequately to all relevant principles in preparing their proposals, or provide a justification for any failure to do so.**

Principle	Description	Check
<b>Response to character</b>	Do the proposals demonstrate a response to the character of the area as identified within the Character Study in Section 3?	
<b>Response to constraints and opportunities</b>	Do the proposals demonstrate a response to the site constraints and opportunities as identified within the Site Appraisal in Section 3?	
<b>DES38: Sense of place</b>	Does the design generally reflect or respond to the scale of the existing settlement and positively contribute to the character as identified in the Character Study in Section 3? If not has a strong justification been provided?	
	Does the scheme incorporate variations in height responding to the location within the proposal, for instance reflecting the street hierarchy, enhancing legibility of an important corner or node or emphasising a particular use?	
	Is the location of any apartment buildings appropriate and justified?	
	Does the new development adopt a simple form in-keeping with the character of the area? If not is the reason justified?	
	Do corner buildings 'turn the corner' providing frontage to both streets?	
	Has the applicant demonstrated how the use of corner buildings has been considered in order to aid legibility?	
	Does the scheme avoid exposed, blank gable ends with no windows fronting the public realm?	
<b>DES39: Enclose and animate the street</b>	Does the development ensure that all streets and public spaces have good natural surveillance from buildings?	
	Does the development clearly define public and private space through the use of appropriate boundary treatments? If not, is this justified?	
	Are these boundary treatments reflective of the area as established in the Character Study?	
	Are all property entrances directly onto and easily visible from the public realm? Are they legible and welcoming?	
	If there are apartments within the scheme are their communal entrance cores generous, well lit by natural light and naturally ventilated?	

Principle	Description	Check
<b>DES40: Architectural integrity</b>	Has the applicant demonstrated an architectural approach and identity borne from the place and reflected through the Character Study?	
	Is the choice of door and window design appropriate to the overall design approach?	
	Does the roofscape proposed reflect the simple roof structures characteristic within the area?	
	Are larger buildings broken up into a series of smaller spans or modules of a simple form to ensure the roof does not dominate the building or surrounding area?	
	If chimneys are incorporated into the design are they reflective of the character of the area?	
	If dormers are incorporated into the design are they reflective of the character of the area?	
	Are they positioned to line up with openings on the main façade?	
	If rooflights are proposed are they appropriately sized and positioned out of public view?	
	Is the palette of materials and detailing proposed of high quality and reflective of the character of the area as established through the Character Study?	
<b>DES41: Utility meters / external pipes</b>	Are utility meters located where they are both convenient and unobtrusive?	
	Are external service pipes / rainwater goods and other apparatus grouped together and discretely located on elevations so that they are not prominent?	
<b>DES42: Privacy</b>	Does the design respect the privacy of existing residents in adjacent dwellings?	
	Does the design respect the privacy of future residents in the proposed development?	
<b>DES43: Amenity</b>	Do the proposals provide attractive and usable external amenity space appropriate to the location of the proposal and the type and size of accommodation?	
<b>DES44: Daylight and sunlight</b>	Do all properties receive adequate daylight and sunlight?	
	Does the proposal avoid providing single aspect north facing apartments?	
	Does the proposal minimise provision of single aspect south facing apartments (which are subject to overheating)?	
<b>DES45: Noise, air and light pollution</b>	Is the proposal designed to respond to and minimise the impacts of noise, air and light pollution?	

Principle	Description	Check
<b>DES46: Commercial buildings</b>	Do employment buildings (where appropriate) respond positively to the character and architectural traditions of the area in terms of scale, mass, form, materials and detailing?	
	Are buildings materials appropriate to the context of the sites location? If in a rural / countryside location are they of muted colours, avoiding reflective materials, to minimise visual impact?	
	Is the ground floor of commercial buildings articulated to create a more human scale with entrances generous and welcoming?	
	Do reception areas and office space positively contribute to the surveillance of entrance areas and forecourts?	
	Is signage on commercial buildings in proportion with the scale of building and appropriate to the streetscape?	
<b>DES47: Sustainable buildings</b>	Are buildings designed to minimise the use of resources and energy?	
<b>DES48: Living roofs and walls</b>	Has the applicant agreed with the council whether living roofs are appropriate within the context of the site?	
	Is the building position and orientation suitable for the chosen living roof or wall system?	
	Has additional structural support to the roof been allowed for as living roofs are heavier than traditional ones?	
<b>DES49: Building materials</b>	Has the applicant considered materials with low embedded energy, materials that can be recycled and materials that have low toxicity?	
	Has the applicant considered materials from local sources wherever possible?	
<b>DES50: Local energy production</b>	Has the applicant integrated energy efficient solutions and renewable energy production into their development?	
<b>DES51: Reducing water demand</b>	has the applicant taken steps to reduce water demand, waste and enhance efficiency?	



# 7 Development in the countryside

Much of Aylesbury Vale is rural in character with buildings located either individually or in small groups of dwellings within hamlets or as farm buildings. Outside the main settlements landscape is the dominant feature with buildings situated within the landscape and / or countryside.

Traditional buildings are successfully integrated into their landscape settings through the use of simple building forms, local materials, structural planting and in response to topography and local climatic conditions.

Aylesbury Vale has a varied landscape character influenced by the underlying geology. This in turn influences both the vegetation, settlement patterns and the building materials. Throughout the Vale the countryside plays a unique role in defining the character of the area.

The council, through its role as Local Planning Authority is a custodian of the countryside and wants to see any development within these areas integrated into the landscape in a sensitive and appropriate manner.



# 7. Development in the countryside

## Response to landscape

VALP Policy Refs: NE4; NE8; BE2

### 7.1 Responding to the landscape

#### Principle DES52: Respond to the landscape character and setting

Applicants should demonstrate how the landscape character has been considered from the outset of the design process as an integral part of their proposal (refer to Principle DES2). This will be an important requirement within the Design and Access Statement.

Buildings within rural and lower density areas within the Vale should be simply integrated into their setting to be at one with the landscape.

Applicants must understand and respond to the particular characteristics of their site (refer to Principle DES8: Site Appraisal).

As a general rule, buildings should not be located on ridgelines or exposed sites where the buildings will become a dominant visual feature to the detriment of the existing landscape character.

Development proposals should work with the topography. Integrating buildings around the existing topography can help to soften the appearance of a new development within the

landscape. The topography of the site can also be used to provide natural shelter from wind and therefore prevent heat loss in winter.

Buildings on sloping sites should respond to the topography avoiding deep plan buildings and responding to the contours of the landscape rather than cutting across them.

Applicants should retain important landscape features, mature trees and planting wherever possible and incorporate these features into the landscape structure.

Sufficient space should be allowed around new buildings and consideration must be given to the relationship of buildings with their boundaries on all sides.

Landscape elements, tree planting, and boundary treatments should be used to establish the building within the landscape, visually anchoring the building to its landscape setting.

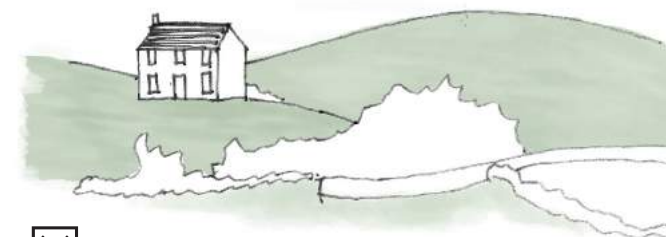

Figure 7.1: Buildings should not be located on ridgelines or exposed sites and instead should integrate into their setting

#### Reason

7.1.1 The countryside of Aylesbury Vale, away from the built-up area of Aylesbury is typified by a varied, rolling landscape. The escarpment of the Chiltern ridge provides a distant horizon whilst the lower hills, some with wooded crests, give an intermediate scale. Pockets of old woodland survive. Villages are mostly well-defined and form identifiable clusters seen from a distance, often with a church tower giving a focus to their overall composition. Farm complexes also form smaller building clusters dotting through the landscape.



## 7. Development in the countryside

## Response to landscape

VALP Policy Refs: NE4; NE8; BE2

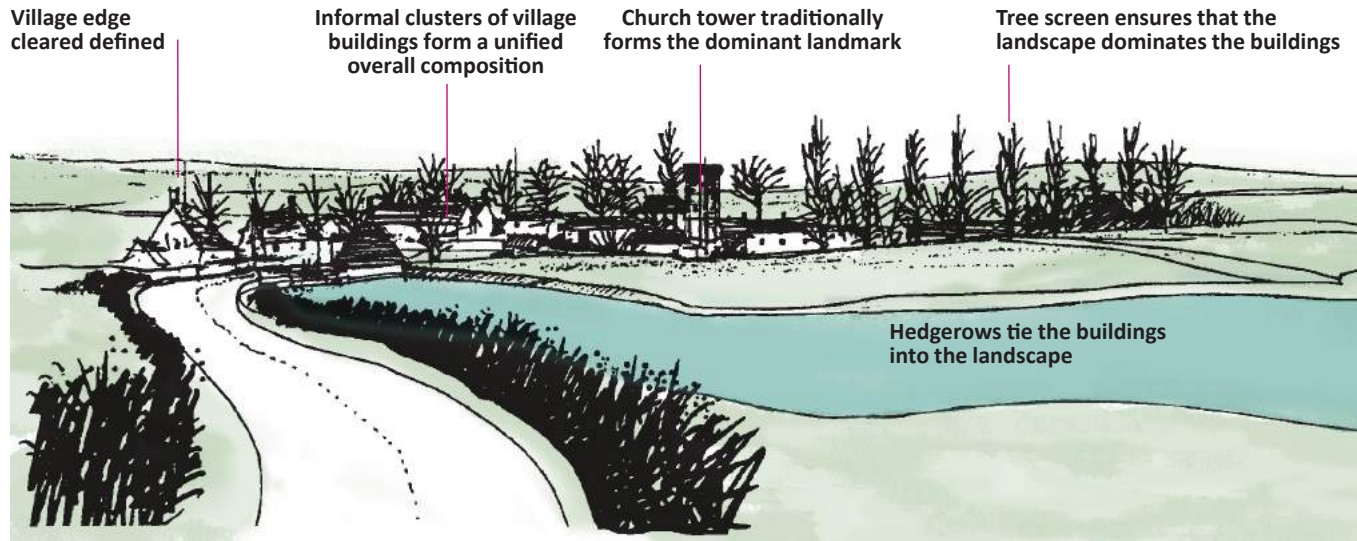

Figure 7.2: Typical form of a village, set within the landscape, in Aylesbury Vale

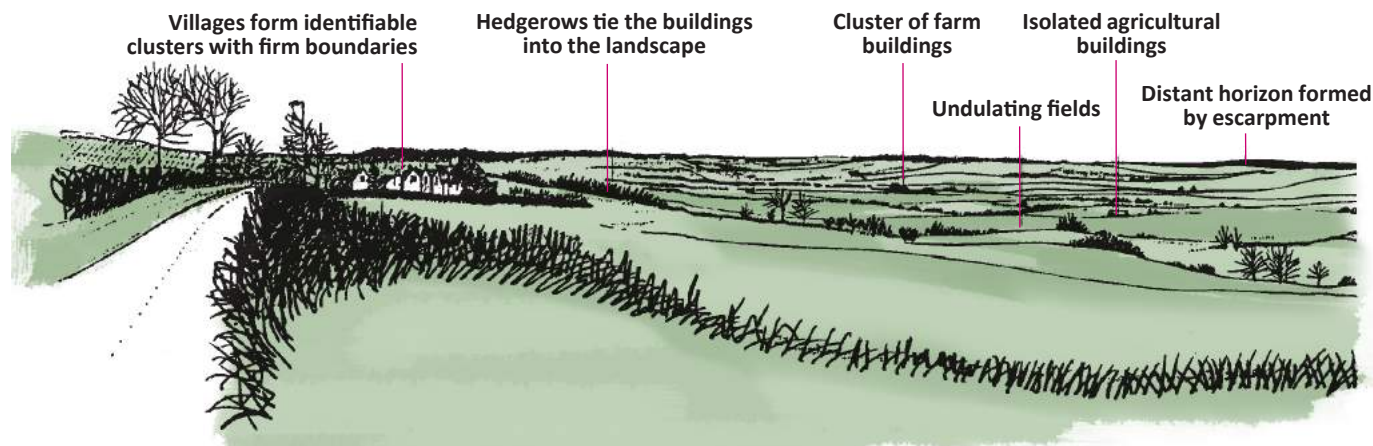

Figure 7.3: The characteristics of the Aylesbury Vale landscape

7.1.2 The landscape is given form and pattern by the network of fields and boundaries. Walls, hedgerows and trees tie the elements of the landscape together. Natural shapes and irregular patterns give a strong visual structure at all scales. Panoramic views see these elements knitted together across the landscape. Distant landmarks give scale. Country roads give a constantly evolving sequence of spaces and forms. Winding roads are complemented by mature trees which give punctuation and emphasis.

7.1.3 In all the views near and far across the countryside the treatment of boundaries is fundamental to their character. As well as defining the broader scale of the landscape, field boundaries emphasise the curves of country roads. They also provide the setting for buildings in the countryside. Most established development is seen over a boundary, so that the buildings are given a base, visually anchored to their landscape setting. Their setting may be further complemented by tree planting, either in groups or single specimens.

7.1.4 This relationship between the landscape, and the dwellings within it, is important and gives the area its rural character and charm.

7.1.5 Whilst one can point to examples of prominent eighteenth and nineteenth century country houses within the Vale that stand proudly in the landscape as dominant features these tend to be the exceptions.

7.1.6 Country houses have a unique relationship with their landscape setting; their exceptional architectural and generally planned formal landscape settings are unique elements within the landscape and not the typical relationship between built form and the landscape.

# 7. Development in the countryside

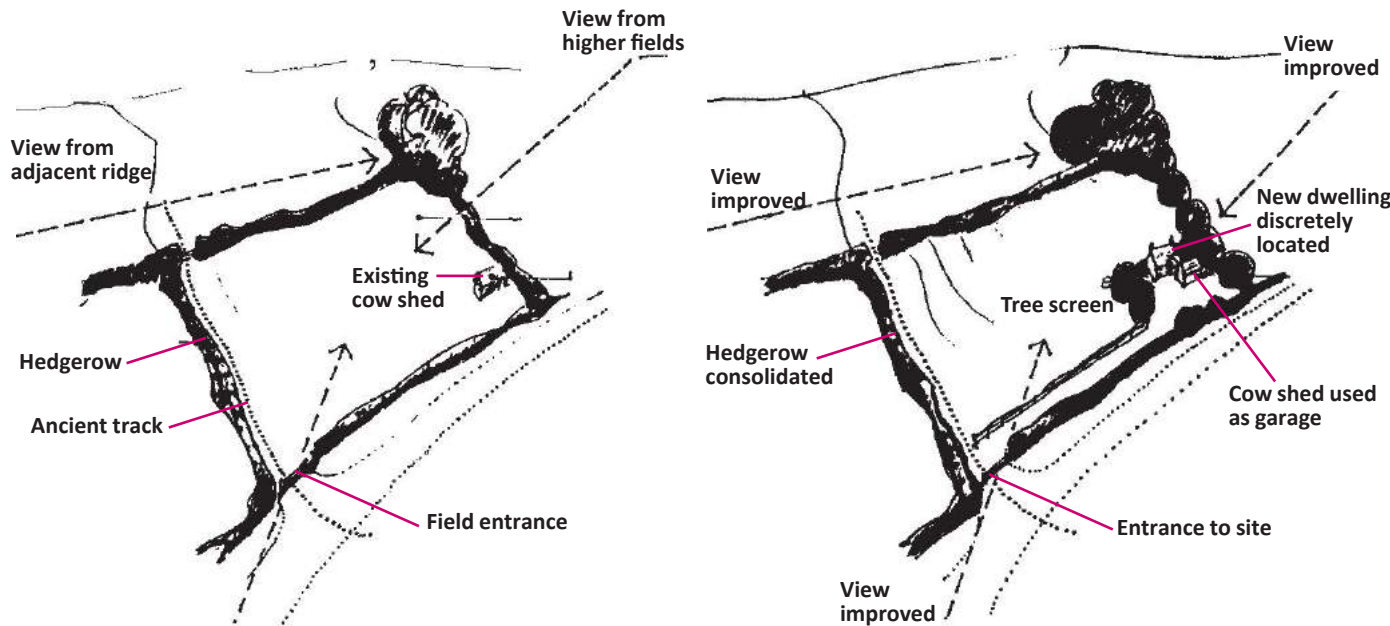

Figure 7.4: Understanding a site is critical to developing appropriate proposals

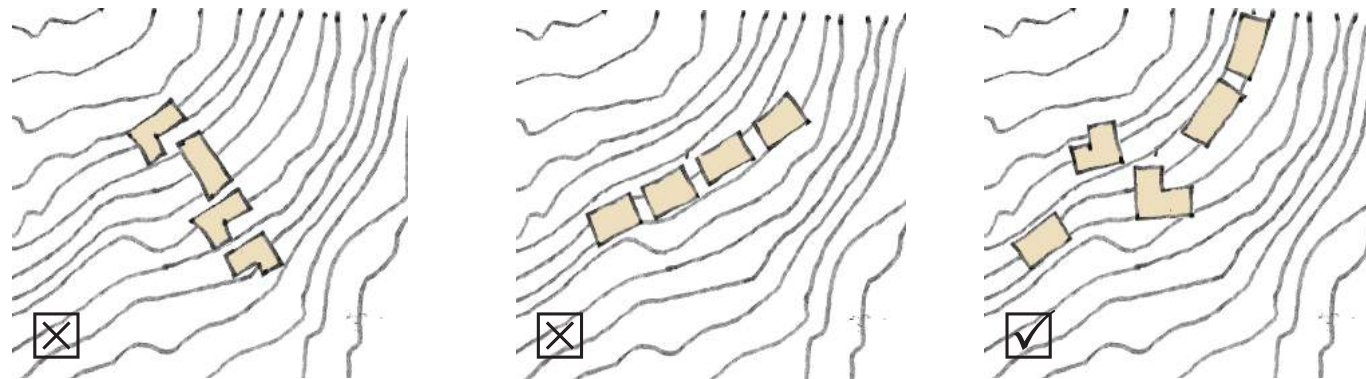

Figure 7.5: Proposals on hillsides should avoid development set at one level to avoid buildings 'merging' together, which is generally out of character in rural locations

# Response to landscape

VALP Policy Refs: NE4; NE8; BE2

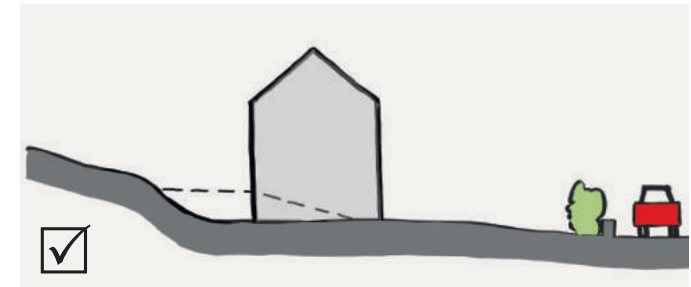

Figure 7.6: Buildings on sloping sites should avoid exposed plinths within the hillside and use the topography to the developments' advantage. Building along the contours of the landscape rather than cutting across them can reduce this issue

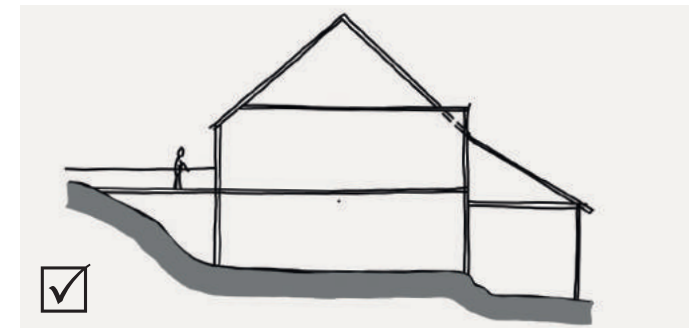

Figure 7.7: Building responds to the sloping site

# 7. Development in the countryside



Figure 7.8: Traditional farm complex that has grown organically keeping the farmhouse as the dominant feature

## Response to landscape

VALP Policy Refs: NE4; NE8; BE2



Figure 7.9: Setting property back from boundaries allows tree planting

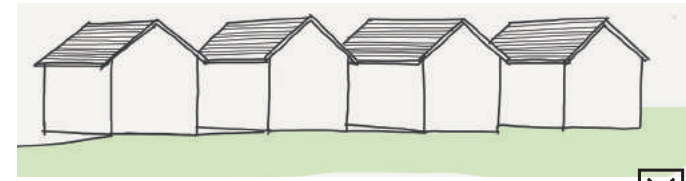

Figure 7.10: Space between buildings is inadequate

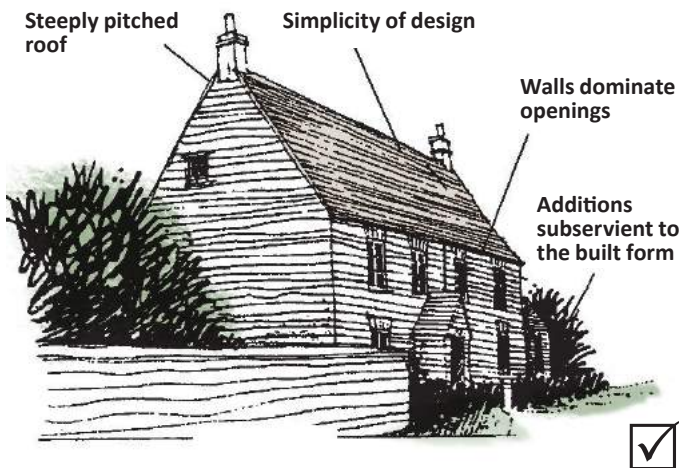

Figure 7.11: The simple design and use of local materials integrates this property within the landscape

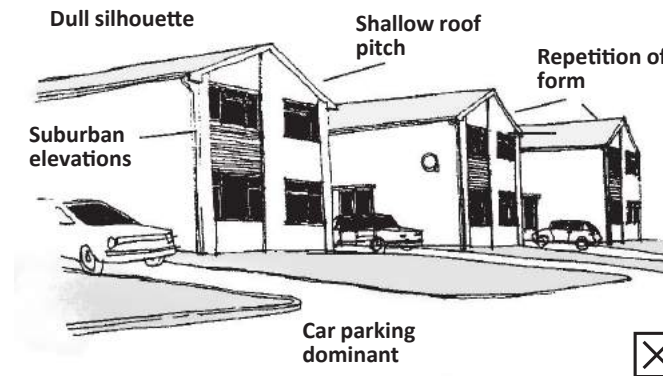

Figure 7.12: Properties do not respond well with the landscape

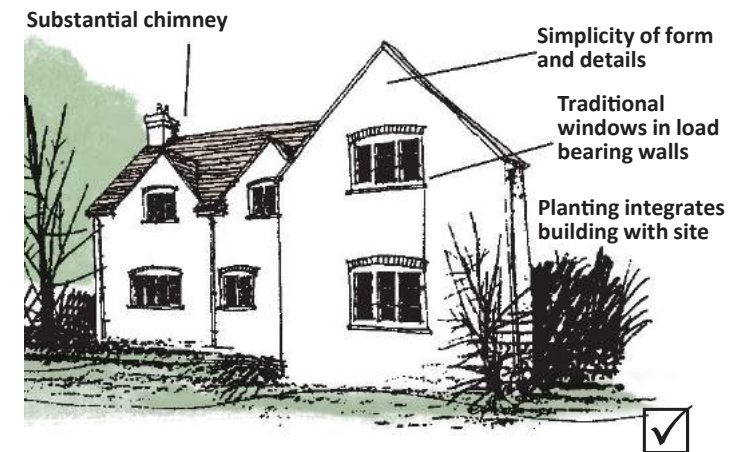

Figure 7.13: Property has a good relationship with the landscape

# 7. Development in the countryside

## Residential buildings

VALP Policy Ref: BE2

### 7.2 Building design in rural areas

#### Principle DES53: Residential buildings in the countryside

The majority of traditional buildings in Aylesbury Vale, in both urban and rural areas, adopt a very consistent, simple form, with rectangular floorplans and pitched roofs. In most instances new development should adopt a similar approach unless a reasoned justification or a strong architectural approach can be demonstrated.

Larger footprint buildings can often appear bulky and should be broken down to create a number of simple geometric forms.

Development heights should be responsive to their context and predominant heights within the area. The majority of development within rural areas in the Vale is one or two storey in height. Development that exceeds these will require strong justifications.

In rural areas buildings can often be seen from many locations within the wider area. As such it is important to understand the appearance of the building as a whole rather than having specific public and private facades. Building materials should respond to the context as set out in Principles DES4, DES6 and DES40.

Where groups of buildings are proposed these should mimic the organic forms of traditional village settlements with buildings clustered around a central space.

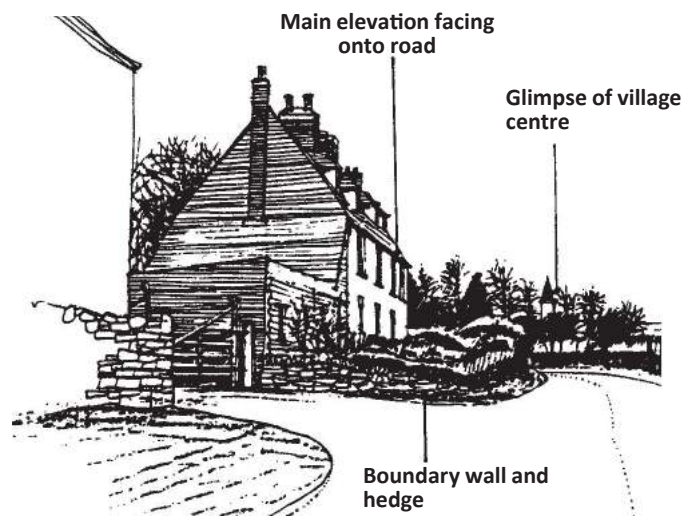

Figure 7.14: Traditional property in village

#### Reason

7.2.1 New buildings in the countryside should be designed so that they fit comfortably in the landscape and respond to context.

7.2.2 Individual houses should have a simple form which may be based on a rectangular plan and have a pitched roof with a central ridge. This basic form may be extended and added-to. Carefully placed 'additions' can enhance the overall composition. Simple forms are the key to success.

7.2.3 Traditionally houses were rarely built over two stories in height. The upper story often used part of the attic with 'A' framed trusses. This kept the ridge height down making for a more compact and efficient building that hugged the landscape and established the tradition of countryside building.

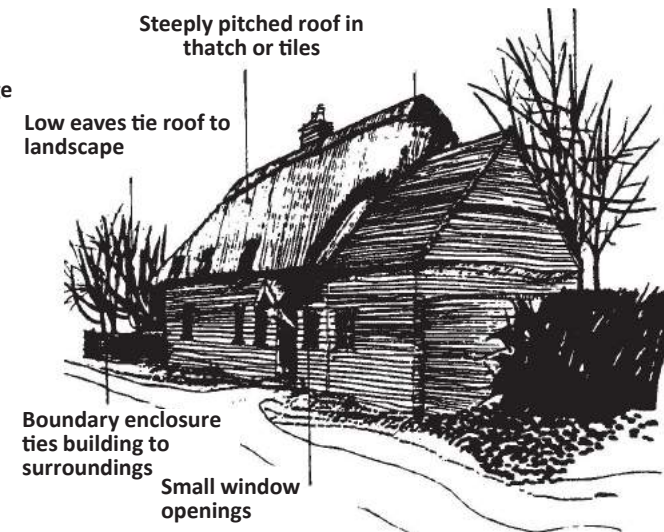

Figure 7.15: Traditional rural property

7.2.4 Thatched and tiled roofs have pitches of at least 40 degrees to ensure efficient dispersal of rainwater. The introduction of slate allowed pitches to be reduced to 30 degrees although these can appear squat from a distance. In all but special circumstances 40 degrees should remain the normal roof pitch. Unequal main pitches should be avoided.

7.2.5 Local building traditions often include low eaves lines and extended roofs. This helps to bring new buildings down in scale and relate them to their sites.

# 7. Development in the countryside

## Residential buildings

VALP Policy Ref: BE2

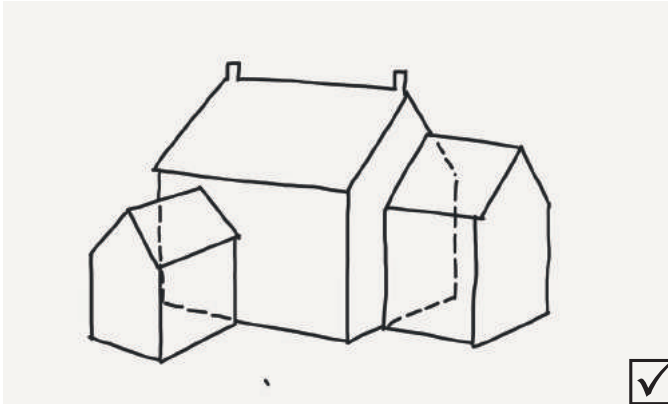

Figure 7.16: Simple building form with sympathetic additions

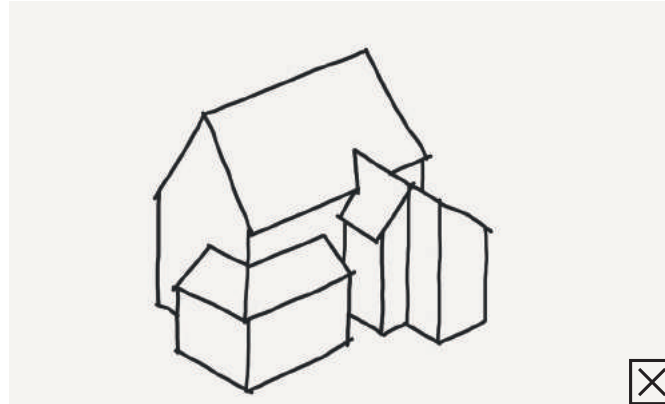

Figure 7.17: Form of additions create awkward interfaces with elevations and roof



Figure 7.22: Extended roof forms help the building to blend into the landscape



Figure 7.18: Building with twin roofs helps to reduce the impression of the overall bulk. However a central valley gutter is created which needs careful detailing.



Figure 7.19: Deep plan buildings can appear too bulky in proportion and out of scale with the countryside



Figure 7.20: Groups of buildings in a cluster mimic the organic forms of traditional village settlements

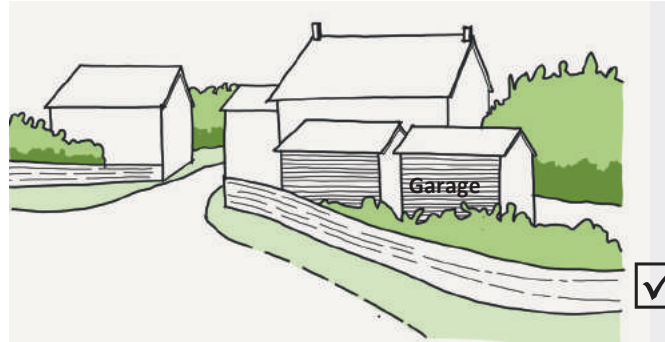

Figure 7.21: Garages in rural areas should be designed to look like outbuildings

# 7. Development in the countryside

## Principle DES54: Rural boundary treatments

The front boundary of a site should be defined by either walls, timber post and rail fencing, railings and/or hedges and trees to reflect the general character of the immediate area. Close board fencing will not be acceptable.

Front gardens should be provided with lawns, tree planting, hedges and only small areas of hard surfacing, either gravel or paving.

Trees and hedgerows, especially along property boundaries should be retained wherever possible. If trees and hedges do need to be removed, they should be replaced within the site.

### Reason

7.2.6 The interface and boundary treatment of plots and the street / country lane and surrounding areas should be reflective of the character of the area as identified in the applicants Character Study.

7.2.7 The Vale's rural areas are generally characterised by the landscape and mature trees, hedgerows and planting are important to their character and setting. These landscape elements in combination with walls, timber post and rail fencing and railings form the boundary and definition of individual plots.



Figure 7.23: Timber post and rail fencing is a traditional boundary treatment

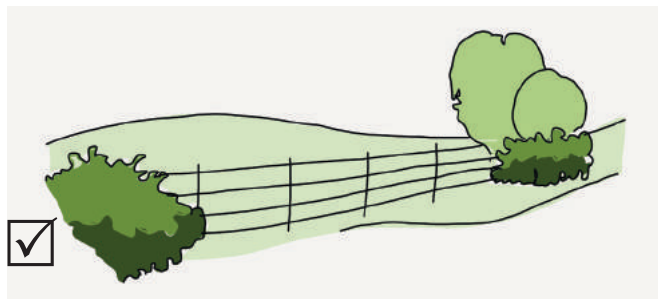

Figure 7.24: Steel railings combine well with hedgerows and are traditionally used as estate boundaries

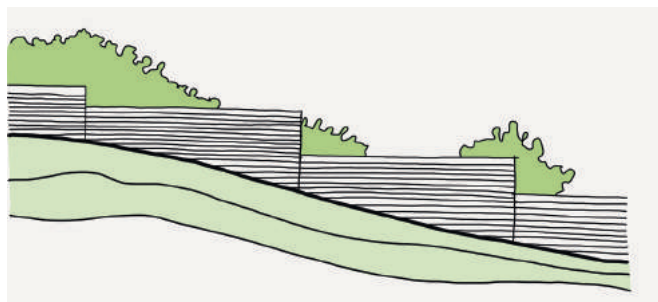

Figure 7.25: Bricks, especially a local type, can form a very strong boundary wall. Walls should not appear over-dominant and look better if associated with planting.

## Rural boundaries

VALP Policy Ref: BE2



Figure 7.26: Over-elaborate and ostentatious entrances are generally out of place in the countryside



Figure 7.27: Decorative railings are usually too suburban to suit the open landscape

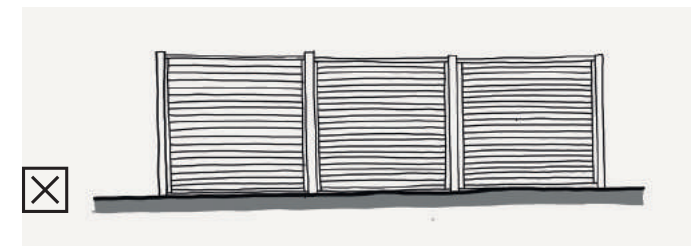

Figure 7.28: Close-boarded fencing can form a barrier obscuring open views. It is hard to detail satisfactorily and is prone to wind damage on exposed sites

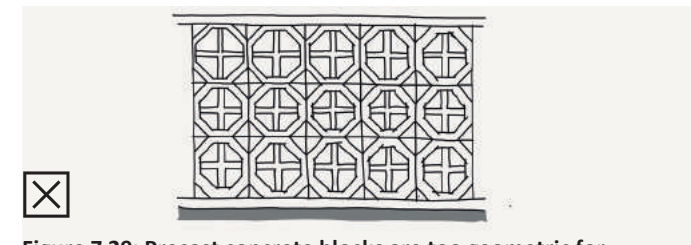

Figure 7.29: Precast concrete blocks are too geometric for countryside use. They impose a rigid pattern of too small a scale which does not accord with the rise and fall of field boundaries

## 7. Development in the countryside

### Principle DES55: Agricultural and equestrian buildings and infrastructure

Where agricultural, equestrian or other non-residential buildings or infrastructure are proposed within rural settings care must be given to how they respond to their landscape setting in order to avoid buildings or infrastructure that are dominant on views and / or unsympathetic to their landscape setting.

Consideration must be given to:

- The location on the site to minimise visual impact;
- The building form with traditional forms that follow traditional barn design preferred;
- Building with traditional materials e.g. clay tiles or slate preferred to roofing felt on roofs, and weatherboarding or brick for walls. Materials should be in muted colours and tones to reduce visual impact;
- The use of vegetation and structural planting (using native species) to act as a visual screen where appropriate;
- The use of lighting, proposals should aim to minimise impact and light spill to surrounding areas.

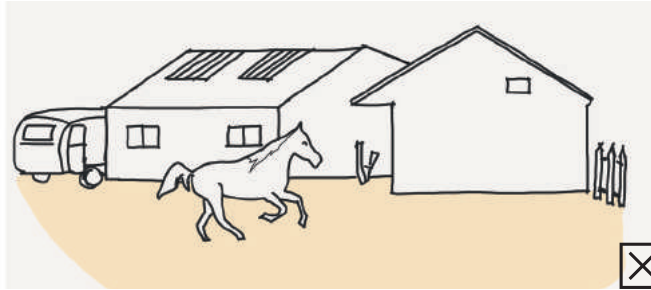

Figure 7.30: Stables and riding schools have become established throughout the countryside. The use may be strongly related to its context but often the associated buildings and paraphernalia clutter up the landscape with unsuitable forms

#### Reason

7.2.8 In recent years there has been a proliferation of larger buildings, often associated with equestrian activities, but also related to sports facilities (e.g. club houses or pavilions) being promoted in the Vale. Whilst these may serve a community function they can have significant visual impact and are often not sympathetic to the character of the area.

7.2.9 Infrastructure in the form of solar farms, water treatment works or roads and railways can have a significant impact on the rural setting and must be carefully planned to minimise this impact.

## Non-residential buildings

VALP Policy Ref: BE2

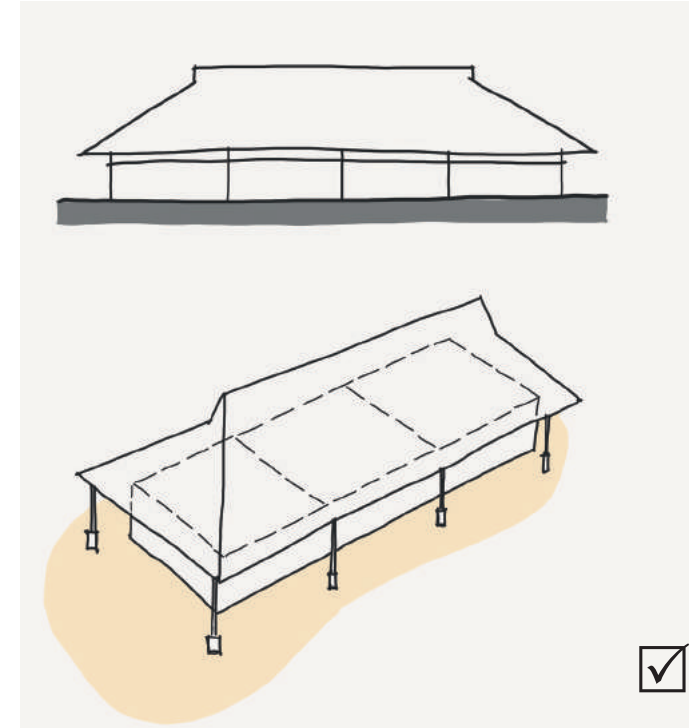

Figure 7.31: Large buildings could follow traditional barn design

### How to use

This table provides a checklist for use by both the applicant and planning officer to check that appropriate consideration has been given to the design of **development in the countryside**.

**PROCESS:** Have you read, understood and applied the principles set out above?

The adjacent table summarises the key principles set out within this section and can be used by applicant and officer as a checklist.

**Applicants will be expected to demonstrate to the council that they have responded adequately to all relevant principles in preparing their proposals, or provide a justification for any failure to do so.**

Principle	Description	Check
<b>DES52: Respond to the landscape character and setting</b>	Has the applicant demonstrated that they understand and have responded to landscape character and to the characteristics of their site including to topography, trees and existing boundaries?	
<b>DES53: Residential buildings in the countryside</b>	Does the scale, form and massing of the building and the materials used respond to local character? Has the applicant considered how the development will appear from all directions?	
<b>DES54: Rural boundary treatments</b>	Does the definition of site boundaries respond to the character of the immediate area? Are existing trees and hedgerows retained?	
<b>DES55: Agricultural and equestrian buildings and infrastructure</b>	Do agricultural, equestrian or other non-residential buildings or infrastructure respond to their landscape setting so that they do not over dominate views or present an unsympathetic response to their landscape setting?	
	Has consideration been given to the location to minimize visual impact, use of traditional materials, use of structural planting or vegetation to act as visual screening and / or use of lighting to minimise impact or light spill?	



## 7. Development in the countryside

This page is intentionally left blank



# 8

## Household extensions

Extensions to dwellings can have a significant impact on the character and appearance of a dwelling itself and the street or area in which it is set. A well-designed extension can enhance the appearance and value of a property, whereas an unsympathetic extension can have a harmful impact, create problems for neighbouring residents, and affect the overall character of the area.

This chapter examines the design approaches that should be adopted when extending a dwelling. It sets out the differing approaches that should be adopted when designing side, front and rear extensions, and loft conversions. Reference must also be made to residential amenity as set out in section 6.3.

Householders are encouraged to make their extensions as energy efficient and sustainable as possible, in line with the design principles set out in section 6.5.



### 8.1 Introduction

8.1.1 Building an extension is not only a matter of enclosing additional floorspace; external appearance and the effect on neighbours also have to be considered. Designing extensions to respect the character and appearance of existing buildings is not only architectural good manners, it also widens the spectrum of prospective buyers if and when you put your home on the market.

8.1.2 Some smaller-scale extensions may constitute 'permitted development' which means they do not need planning permission. However, some exceptions may apply and so householders are encouraged to use the Planning Portal guidance on planning permission and the council's pre-application service for advice on whether planning permission is required.

8.1.3 If planning permission is required, the council has supporting information for householder applications as well as a Local Validation List to help people in preparing applications and ensure all necessary information is included. Refer to the 'Supporting information for your planning application' pages of the council's website.

8.1.4 Building Regulations approval may also be required for any extensions or alterations to a dwelling. Advice on building regulations can be provided by the council's building control service.

8.1.5 If a building is Statutorily Listed or is located within a Conservation Area or within the Chilterns AONB, some forms of development or alteration, that would otherwise be classed as permitted development, will require planning permission, Listed Building Consent or combinations of these. This is to protect the recognised importance and significance of the existing building or its setting.

8.1.6 Any applications that affect a Listed Building or Conservation Area will require a Design and Access Statement and Heritage Impact Assessment.

8.1.7 Extensions to historic buildings can be harmful if their significance is not fully understood. For listed buildings particular weight is placed on retaining the identity, appearance, character and special interest of the building and in some cases building extensions will not be considered to be desirable. Further advice on alterations to your property can be requested through pre-application advice.

8.1.8 More information on how to understand the significance of a heritage asset can be found in the Historic England Good Practice Advice Note 2 – Managing significance in Decision taking in the Historic Environment.

8.1.9 When planning a household extension consideration must be given to the potential impact on wildlife and biodiversity, for instance through the demolition of older buildings or roof spaces, removal of trees, scrub, hedgerows or alterations to water courses. Whenever possible mature trees should be retained and these will need to be appropriately protected during construction. Where impacts on biodiversity are likely a biodiversity survey and report will be required. Refer also to Principle DES13 which requires a biodiversity net gain for all development.

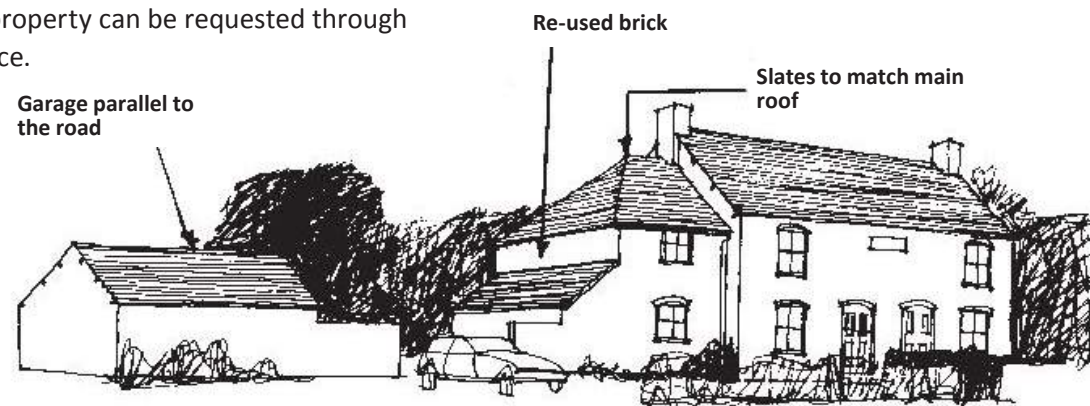

Figure 8.1: A contemporary extension which is physically subservient to the original

# 8. Household extensions

## 8.2 Responding to local character and neighbours

### Principle DES56: Respond to local character

Respond to the character of the area and immediate neighbourhood within which your property is located.

Use this character as a starting point for design in terms of building form, size, position within the plot and relationship to plot boundaries.

Use simple uncomplicated building forms.

Use building materials and details typical of your area or demonstrate how the materials chosen are appropriate.

Where appropriate applicants should make reference to existing character assessments in Conservation Area Appraisals or adopted neighbourhood Plans.

### Principle DES57: Consider your neighbours

Make sure proposed extensions do not intrude upon a neighbour's privacy.

All extensions should take into account the impact on neighbouring properties and should not cause significant harm to the amenities of existing nearby residents in terms to the impact on privacy, outlook, daylight and sunlight, and noise, air and light pollution.

Any extension to a house should not lead to an oppressive or overbearing impact, which would be harmful to the amenity of occupiers of nearby neighbouring dwellings.

In particular, two storey extensions should not encroach beyond a 45 degree line taken from the middle of the nearest ground or first floor window of a habitable room of a neighbouring property.

Any side facing upper floor windows to habitable rooms (e.g. bedrooms) need to be carefully located and/or designed to ensure they do not cause overlooking problems for neighbouring properties.

Carefully consider the position of new garages to avoid an increase in noise and disturbance from vehicle movements.



Figure 8.2: New openings on flank elevations can lead to problems of overlooking

## Local character + neighbours

VALP Policy Ref: BE2

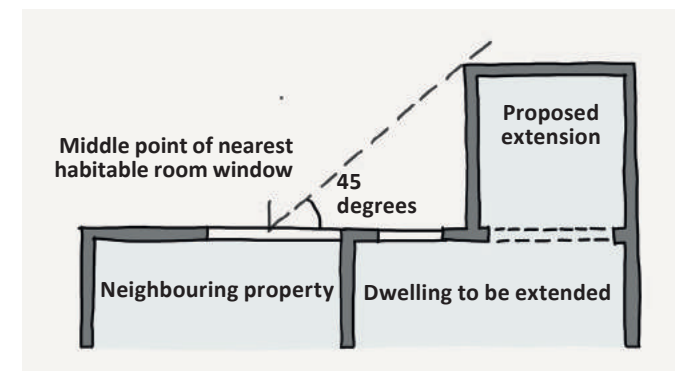

Figure 8.3: The 45 degree rule: The proposed extension should not project beyond the '45 degree line' (indicated by the dashed line) into the neighbours protected area

### Reason

8.2.1 Privacy will be infringed by the construction of an extension which allows views into a neighbouring property or a hitherto secluded garden. The council will wish to avoid situations which diminish the privacy of neighbour's property and will, for this reason, resist balconies, roof gardens, first floor conservatories and flank windows which would permit views into adjacent or nearby properties.

8.2.2 Since the council will take account of any objections from neighbours when assessing a planning application it is advisable to first discuss your proposal with any neighbour who may be affected.

8.2.3 A neighbour's permission is required if foundations will encroach, or if an extension will overhang or attach to their property (a Deed or Party Wall agreement may have to be drawn up to adequately cover these issues). In addition, a neighbour's consent will be needed if access to their property is necessary during construction.

# 8. Household extensions

## 8.3 Scale, form and massing

### Principle DES58: Extensions should be subservient to the scale, form and massing of the original dwelling

The original building should remain the dominant element of the property whether you have one extension or several. The effect of any extension should not overwhelm the house from any given viewpoint.

Extensions should not result in a significant loss to the private amenity area of the dwelling.

Any existing external access from the front of the dwelling to the rear garden is a significant asset to service the garden. Consideration should be given to the value of retaining this access.

Extensions should use simple, uncomplicated building forms to compliment and coordinate with the scale, form and massing of the original dwelling.

Applicants should avoid proposals that wrap around the existing dwelling and involve complicated roof forms. This is likely to result in a bulky appearance.

### Reason

8.3.1 Extensions that appear subordinate to the original dwelling can help to maintain the character and integrity of the original dwelling. Setting back an extension from the main building line and / or proposing extensions that are lower / smaller in scale will help to ensure this.

8.3.2 Once an extension begins to match or exceed the size of the original building then the architectural integrity of the original structure tends to become lost.

## Scale and massing

VALP Policy Ref: BE2

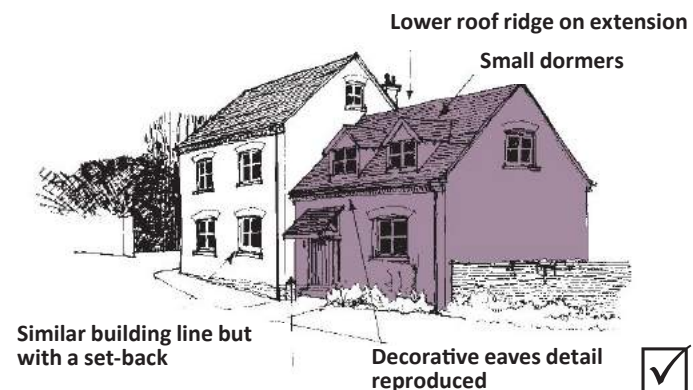

Figure 8.4: Extensions which are smaller, lower and which follow the design of the original houses are normally acceptable



Figure 8.5: A lower, set back extension which repeats the overall shape and design of the house

# 8. Household extensions

## Scale and massing

VALP Policy Ref: BE2

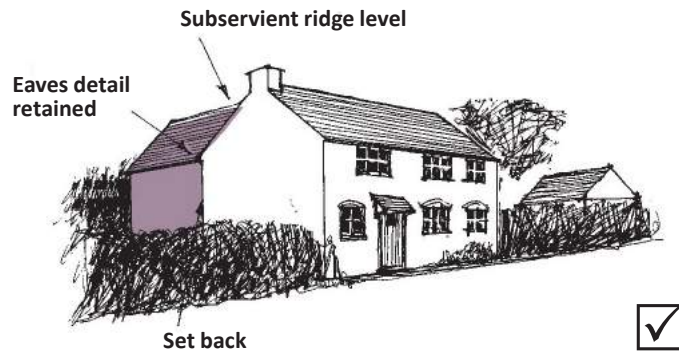
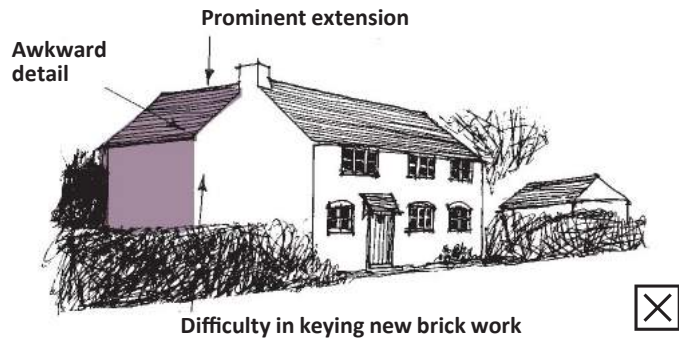

Figure 8.6: Extensions can adversely change the shape of buildings (TOP)... unless steps are taken to avoid this (BOTTOM)



Figure 8.7: Extensions which are larger than the parent building can harm the appearance of the original house

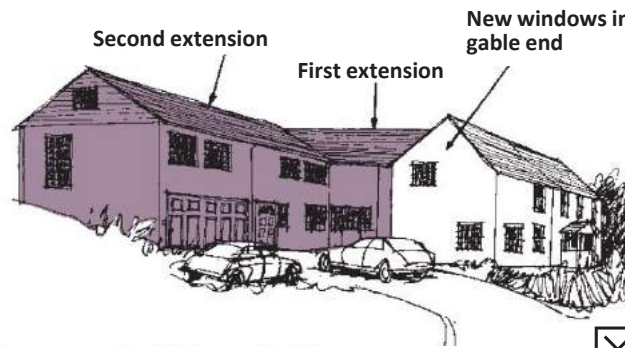

Figure 8.8: Incremental additions which have distorted the original composition of a relatively small house

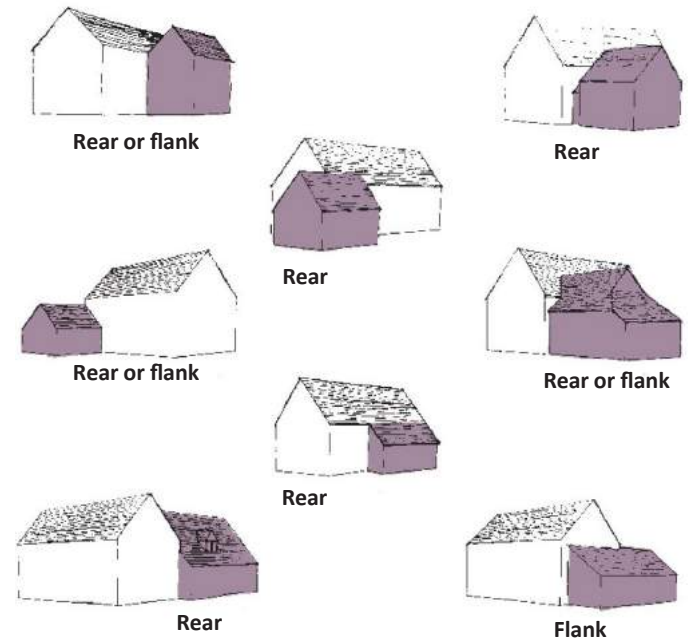

Figure 8.9: Extensions of similar form, but of subordinate size, are generally acceptable, subject to all other criteria set out in this chapter

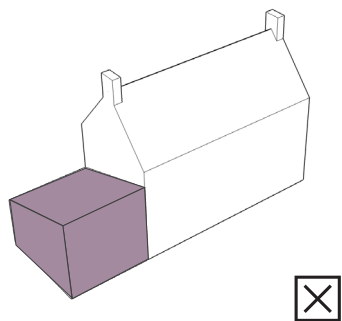

Figure 8.10: The scale and massing of the extension bears no relationship to the existing dwelling

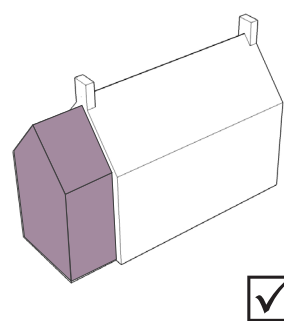

Figure 8.11: The extension has an appropriate scale and massing in relation to the original dwelling

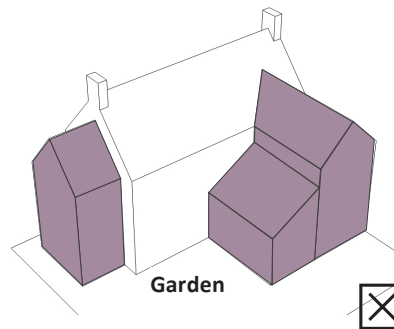

Figure 8.12: Multiple extensions over time can have a compound impact and overwhelm the original dwelling

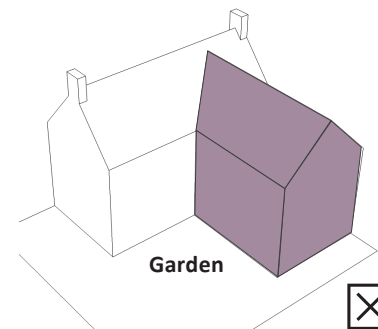

Figure 8.13: The size of the extension overwhelms the original dwelling

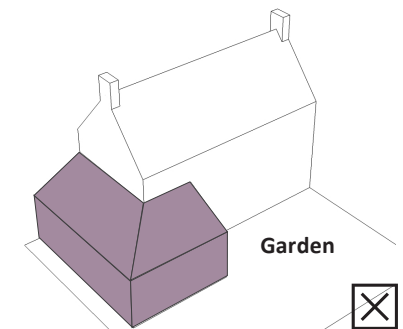

Figure 8.14: Extensions that wrap around the existing dwelling should be avoided

## 8. Household extensions

### Principle DES59: Respond to the design of the original dwelling

Extensions should respond to the design of the original dwelling and applicants should demonstrate how local character has informed the design proposal.

Applicants that do not use materials to match those of the existing dwelling should demonstrate the appropriateness of the alternatives proposed.

Owners of Listed Buildings or buildings in Conservation Areas should also make use of the National Heritage List for England, Conservation Area Character Appraisals or any other assessment of the building's significance when considering an extension so that their design sustains or enhances the features that contribute to its significance or better reveals them.

The position, size, proportion, height and style of new windows and doors and the ratio of solid wall to openings all help to define the character of a dwelling. It is important, therefore, that the extension responds to the existing pattern of window and door openings.

### Reason

8.3.3 There are generally two design approaches that can be adopted when considering extending a property.

8.3.4 The first is to consider the materials, architectural features, window sizes and proportions of the existing building and to recreate this style to design an extension that matches or complements the existing building.

8.3.5 The second is to consider the proportion, materials, architectural features and window sizes of the existing building and to develop a contemporary response to those by taking cues from the key aspects.

8.3.6 In the former case, an extension might go unnoticed. In the latter case the extension would be different yet compatible or complementary.

8.3.7 Both options can create successful, well designed extensions that can be mutually beneficial to both the house and the wider area. The best extensions are architecturally attractive in their own right.

## Responsive design

VALP Policy Ref: BE2

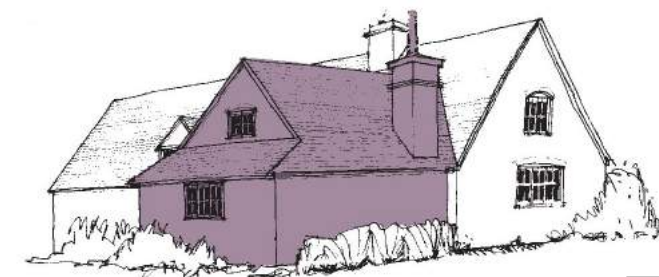

Figure 8.15: A polite extension which maintains the character of the existing house

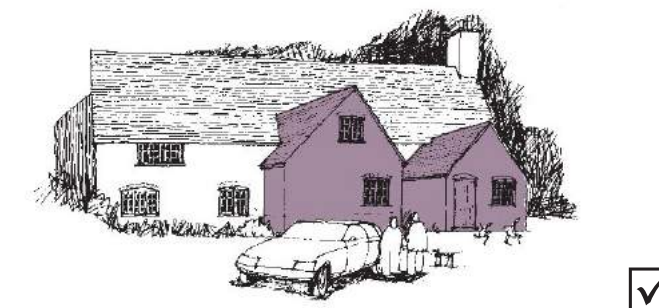

Figure 8.16: Extensions built in the past generally show a family likeness to the shape of the original house



# 8. Household extensions

## Responsive design

VALP Policy Ref: BE2

Steep roof pitch

Decorative chimney stack



EXISTING PROPERTY

Partially concealed decoration on chimney stack

Lower roof pitch than on original house



Difficult to match old and new facade work

Uncharacteristically large span depth

UNACCEPTABLE PROPOSAL

Decorative part of chimney stack remains visible

Roof pitch to match existing

Set back to disguise junction of new facade work



Narrower span depth

ACCEPTABLE ALTERNATIVE

Figure 8.17: Designing an extension to respond to the character of the existing property



Figure 8.18: Despite the set back this prominent extension does not respect the design of the original building



Figure 8.19: The use of architectural good manners provides a scheme that is more responsive to the existing dwelling

# 8. Household extensions

## Side extensions

VALP Policy Ref: BE2

### 8.4 Detailed principles

#### Principle DES60: Side extensions

Side extensions should be subservient to the original dwelling and normally be set back from the front of the house to retain the proportions of the original building and reduce the visual impact of the join between existing and new.

Extensions that close an important gap within the street scene or lead to a terracing effect will not be accepted.

Two storey extensions should generally be constructed with the same angle of pitch as the existing roof.

The design of all side extensions should take into account the impact on neighbouring properties in terms of overlooking, overshadowing and over dominance.

#### Reason

8.4.1 In built-up areas, the gaps between dwellings can often be small. Cumulatively, these gaps can make an important contribution to the character of an area. Extending at two storeys to the side of a detached or semi-detached dwelling can result in development right up to the site boundary, resulting in an inappropriate 'terracing effect'.

8.4.2 The problem can be exacerbated where an extension has the same roofline as the original building and where a neighbouring property already lies on, or close to, the boundary.

8.4.3 To reduce such a 'terracing effect', it is desirable to maintain a gap between the extension and the site boundary and for the extension to have a lower ridge height than the main building. The extent of the gap should be determined by the pattern of development in the area but, in general, it should not be less than one metre wide in urban areas and a greater space may be required on the edge of towns or in rural areas in order to preserve the open character of an area.

8.4.4 An alternative way of avoiding a terracing effect is to set the first floor element of the extension back from the front elevation – it should be set back at least one third of the depth of the dwelling.



Figure 8.20: The infilling of gaps between buildings is often detrimental to visual amenity

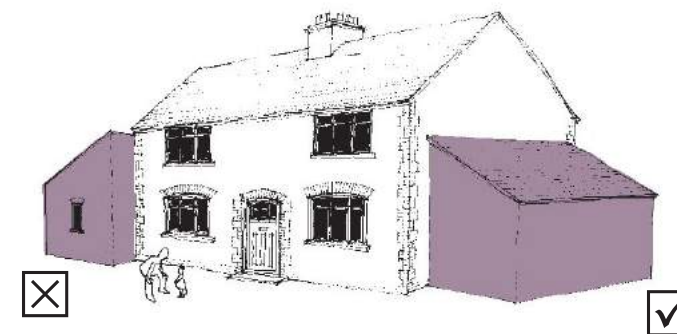

Figure 8.21: Side extensions should be set back from the main building line

# 8. Household extensions

## Front extensions

VALP Policy Ref: BE2

### Principle DES61: Front extensions, canopies and porches

The front elevation of a house is the most vulnerable to unsympathetic alteration. Only small additions which do not harm the quality or character of the building are likely to be acceptable.

Front extensions will be resisted where they have a significant impact on the street scene or are damaging to the appearance of a dwelling.

Modest front extensions or porches that reflect the character of the existing property in terms of their scale, details and materials are more likely to be acceptable. Porches should be in proportion with the main dwelling.

Front extensions are more likely to be acceptable where the building line is staggered or where the dwelling is set well back from the road. They should normally be designed with a pitched roof.

The council will not normally grant permission for a front extension (either at single or two storeys) which protrudes beyond a 45 degree line (drawn in the horizontal plane) from the centre of the nearest window in a neighbouring house or flat (refer to Figure 8.3). Windows to a hall, bathroom, utility room, cloakroom or pantry are discounted.



Figure 8.22: Porches of similar form and materials to the dwelling are generally acceptable



Figure 8.24: Porch design does not relate well to the shape or design of the building

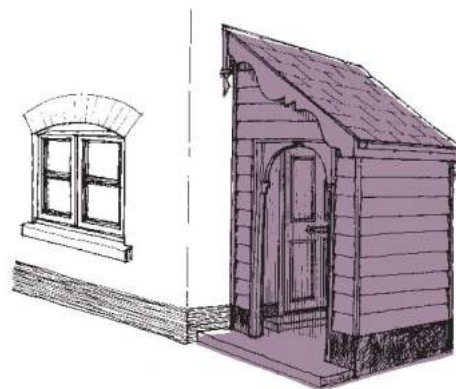

Figure 8.23: Historic porch designs often picked up the architectural characteristics of the house

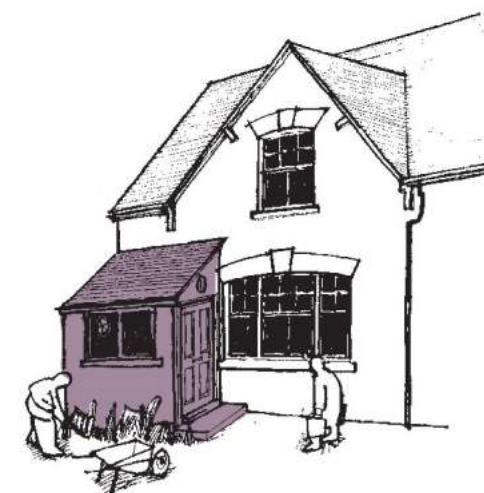

Figure 8.25: Porch extension is built too close to the principal ground floor window

# 8. Household extensions

## Principle DES62: Rear extensions

Rear extensions should not have a harmful effect on neighbouring properties in terms of privacy, overshadowing or overbearing.

In the interest of amenity the distance back from the original main rear elevation is restricted. This distance should normally be no more than three metres in the case of a terraced house and four metres for a semi-detached house.

An adequate distance between facing habitable rooms must be retained to enable people to feel comfortable in their own homes (refer to Principle DES42).

Rear extensions should not have a detrimental impact on the existing dwellings usable amenity space.

The council will not normally grant permission for a rear extension of more than single storey height if any part of that extension protrudes beyond a 45 degree line (drawn in the horizontal plane) from the centre of the nearest window to a habitable room of a neighbouring dwelling, on the same elevation as the rear of the extended property.

The 45 degree line is intended to prevent undue loss of daylight or sunlight to neighbouring properties, to avoid excessive shadowing of gardens, to protect residential amenity and preserve a reasonable standard of outlook. Refer also to Principle DES57 and Figure 8.3.

### Reason

8.4.5 Extending terraced and semi-detached dwellings represents the most significant challenge in terms of potential loss of residential amenity due to the close proximity of neighbouring properties. Problems can be mitigated by limiting the scale of the proposed extension and applying the 45 degree rule (refer to Figure 8.3). Single storey extensions are easier to accommodate successfully. An alternative solution is for neighbours of adjoining properties to work together to extend both dwellings concurrently.

8.4.6 Single storey rear extensions and conservatories often do not need planning permission as they can be built under 'permitted development' rights. The council's planning service can advise on whether planning permission is required.



Figure 8.26: Sunlight should be considered even where extensions comply with the 45 degree guidelines

## Rear extensions

VALP Policy Ref: BE2

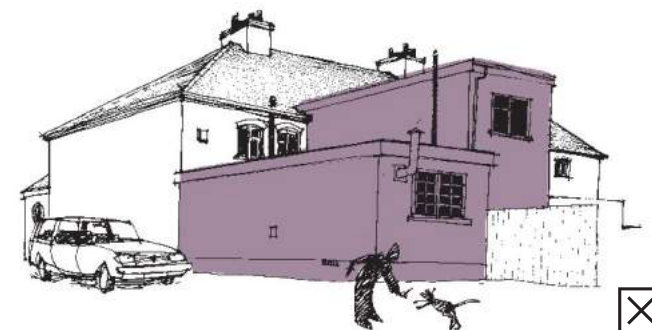

Figure 8.27: Bulky, box like extensions should be avoided in favour of smaller additions which respect the form of the original building

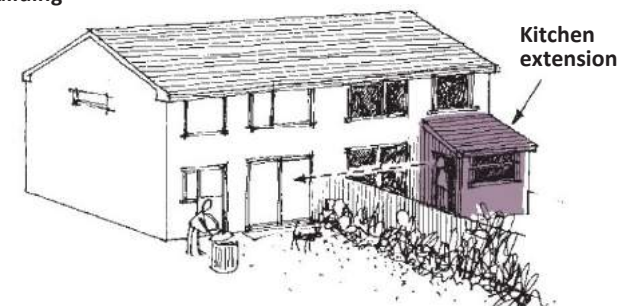

Figure 8.28: Flank doorways can lead to overlooking

Neighbours permission required for overhang or encroachment of foundations

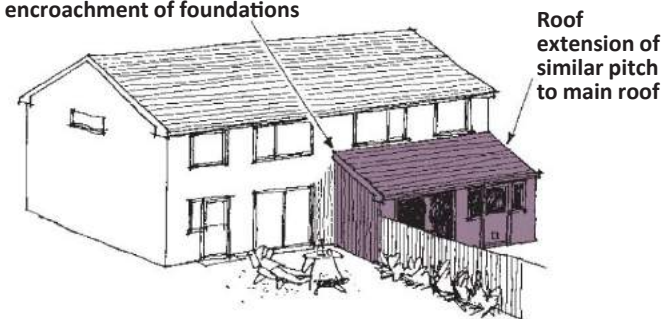

Figure 8.29: Extensions across the back of buildings will make the existing rooms darker inside than before

# 8. Household extensions

## Rear extensions

VALP Policy Ref: BE2

### Principle DES63: Loft conversions and roof extensions

As a general rule extensions that alter the existing ridge of the roof or significantly alter the roof profile of a building will not be accepted.

All two storey extensions should generally have full pitched roofs clad in suitable materials. It may be that a better quality roof material than those on the original could be used (i.e. the original building could have been inappropriately retiled). Natural slate or plain clay roof tiles are preferred on older properties.

Single storey extensions, which are visible from a public area, should generally have pitched roofs. Pitched roofs are also preferred on single storey rear extensions.

Dormer windows should be designed as features principally to provide light and ventilation. They should be small and should sit appropriately in the roof-slope, well above the eaves line, well below the ridgeline and set in from the gable ends. Two or three smaller dormers are often more successful than a single large dormer.

Where a clear rhythm of fenestration is established, the position and proportion of dormer windows should respond to existing windows and/or doors.

Dormers should generally have pitched roofs, be physically small and set into the roof slope so that they are not a strident feature in the roof as a whole. Rear roof slopes, which are less visible, may be able to accept larger additions but these need to be carefully designed as over-dominant or box-like roof extensions can be particularly incongruous. Alterations to the roof, as a whole, should not destroy the original roof form and the materials selected should be compatible with the existing roof material. Rooflights should be small and preferably positioned on less prominent roof slopes.

Flat roof dormers may be acceptable to the rear of properties provided they don't rise above the main ridge of the roof, are subservient to the main dwelling and do not dominate the roof plane, do not impact on the privacy of neighbours and that their design is informed by the character and appearance of the existing dwelling and the surrounding area.

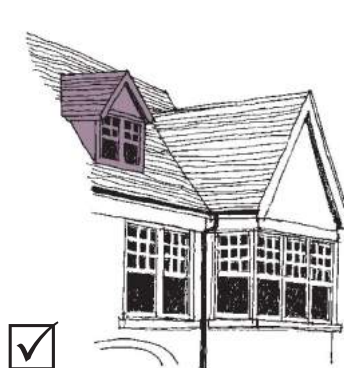

Figure 8.30: Small, vertically proportioned dormers designed to respect the character of the house are normally acceptable



Figure 8.31: Bulky dormers of unsympathetic appearance detract from the building elevation



Figure 8.32: Box-like roof additions that impact on the architectural integrity of the existing building and on the street scene

# 8. Household extensions

## Principle DES64: Car parking and garages

Building extensions may reduce the potential for on plot car parking and result in this car parking being shifted onto the street. In many locations this will be unacceptable.

Residential extensions that increase the impact of car parking through a reduction in the space available for landscaping that helps to soften this car parking should also be avoided.

Where residential extensions are proposed to provide garages these must be designed so that they appear to belong to the dwelling and to be subservient to it. This can be achieved through the use of similar materials and similar or steeper roof pitches and by stepping the garage back behind the building line of the dwelling.

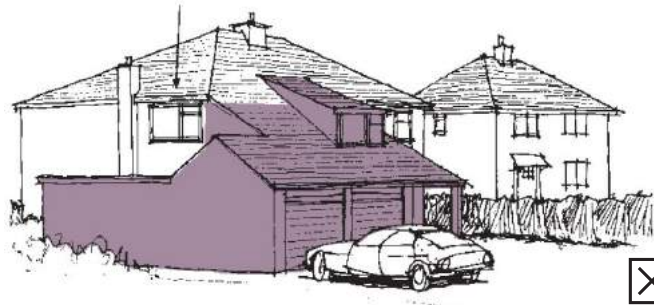

Figure 8.33: Prominent extension to front of building incorporating garage is dominant on the dwelling

Garage designed to respect the shape of the house

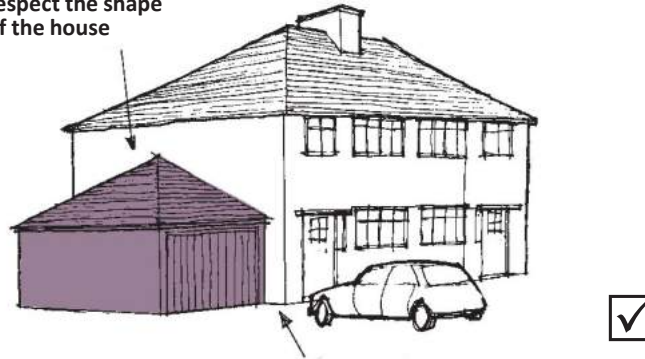

Figure 8.34: Garage design which appears to belong to the existing house

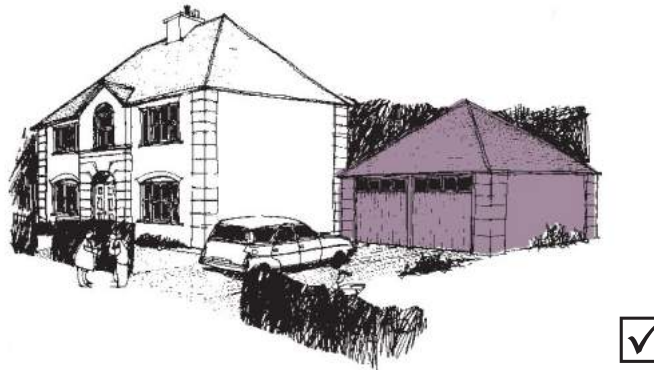

Figure 8.35: Garages which follow the materials used on the house, set back in a subordinate position and with planting are generally acceptable

## Car parking + garages

VALP Policy Ref: BE2; T6



Figure 8.36: Gradually increasing the size of a house inevitably leads to greater demands for off-street parking, often to the detriment of visual amenity



Figure 8.37: The use of parapets on garages is not encouraged. A preferred arrangement is for pitched roofs of similar form to the main roof



Figure 8.38: Garages which are forward of the main building line and of dissimilar shape are unlikely to receive permission

# 8. Household extensions

## Checklist

### How to use

This table provides a checklist for use by both the applicant and planning officer to check that appropriate consideration has been given to the design of a **household extension** as part of an application.

**PROCESS:** Have you read, understood and applied the principles set out above?

The adjacent table summarises the key principles set out within this section and can be used by applicant and officer as a checklist.

**Applicants will be expected to demonstrate to the council that they have responded adequately to all relevant principles in preparing their proposals, or provide a justification for any failure to do so.**

Principle	Description	Check
<b>DES56: Responding to local character</b>	Has the applicant demonstrated how the proposal responds to and respects the character of the area and the immediate neighbourhood?	
<b>DES57: Consider your neighbours</b>	Has the applicant considered and demonstrated that the proposal does not cause significant harm to neighbouring properties in relation to overshadowing, privacy or an oppressive or overbearing impact?	
	Does the proposal comply with the 45 degree rule?	
<b>DES58: Scale, form and massing</b>	Is the extension a simple, uncomplicated building form that compliments and coordinates with the scale, form and massing of the original dwelling? The original building should remain the dominant element of the property.	
	Is the roof form appropriate to the original dwelling? Generally this should be constructed with the same angle of pitch as the existing roof.	
<b>DES59: Respond to original dwelling</b>	Do the materials proposed match those of the existing dwelling or has the applicant demonstrated the appropriateness of the alternatives proposed?	
	Does the proposed extension respond to the existing pattern of window and door openings?	
<b>DES60: Side extensions</b>	Is the side extension set back from the front of the house? If not, has the reason been justified?	
	Does the side extension retain important gaps within the street scene and avoid creating a 'terracing effect'?	
<b>DES61: Front extension, canopies and porches</b>	Does the front extension, canopy or porch reflect the character of the property in terms of scale, details and materials?	
<b>DES62: Rear extensions</b>	Does the rear extension avoid detrimental impact on the existing dwelling's usable amenity space?	
<b>DES63: Loft conversions and roof extensions</b>	Are any proposed dormer roof extensions set within the roof slope?	
	Does the position and proportion of dormer windows respond to the location of existing windows and/or doors?	
<b>DES64: Car parking / garages</b>	Does the proposed extension impact on the potential to park on the plot or increase the visual impact of existing parking?	
	If a garage is proposed is it designed in a manner that makes it appear to belong to the dwelling and be subservient to it?	





# 9 Building conversions

There are many buildings in Aylesbury Vale both within settlements and in the countryside that are no longer used or are vacant. These buildings include farm buildings, chapels, schools, factories and offices. The re-use of existing buildings preserves their contribution to settlements and the countryside and is also more sustainable. The embodied energy in a buildings fabric is considerable i.e. it takes a lot of energy to demolish and rebuild existing buildings.

With this in mind the council seeks to encourage the re-use of buildings wherever possible particularly when the building makes a positive contribution to the character of an area. Their conversion and re-use however must be done with great care in order to ensure that the essential character of the original building is not lost or that the contribution the building makes to the wider area is not compromised.

This chapter examines the design approaches that should be adopted when converting a range of existing building types. It should be noted that conversion to residential use is not always the most appropriate solution, particularly where the building is listed or is situated in an isolated location in the open countryside.



# 9. Building conversions

## Agricultural conversions

VALP Policy Ref: C1

### 9.1 Agricultural building conversions

#### Principle DES65: Conversion of traditional agricultural buildings

The primary objective of all conversions of traditional agricultural buildings must be to retain the character appearance and heritage significance of the original building.

Consideration and a careful design response should also be given to the relationship of the building with the surrounding landscape and in particular trees which may make a positive relationship to the buildings setting or impact on the local environment through casting shade.

Where conversion to residential use is proposed this may require compromises in terms of the residential layout and the provision of natural light into all habitable rooms.

The simplicity of traditional farm buildings should be retained in any conversion. It is desirable not to disturb roofs in any way at all and conversions should re-use existing door and window openings and avoid introducing new window and door openings especially on the public facing side. Any new openings should be appropriately proportioned to respond to the original building.

Building materials and the wider public realm design should be sympathetic with the character of the building.

Rebuilding should be avoided whenever possible and, if required, conversions should re-use existing materials and avoid modern replicas.

The introduction of conspicuous domestic features such as chimneys, satellite dishes, aerials, porches and conservatories tend to be out of character with the original building and, wherever possible, such features should be avoided. Rainwater goods should be discretely located.

Internal walls should be retained wherever practically possible and the introduction of additional internal walls kept to a minimum. Timber roof trusses should be retained and not cut or removed to provide head height at first floor level.

When converting a building to domestic use it is important that the design and materials used enable sufficient noise insulation. This is particularly important when a building conversion creates a mix of domestic and commercial uses in close proximity.

A structural report will need to be submitted with any planning application to demonstrate that the building is capable of conversion without substantial rebuilding or extension.

Old farm buildings can support protected species such as bats and barn owls. Bats and their roost sites are highly protected under the Wildlife and Countryside Act 1981 (as amended) and The Conservation of Habitats and Species Regulations 2017. Barn owls are protected against disturbance whilst they are nesting. Applications will need to be supported by appropriate surveys

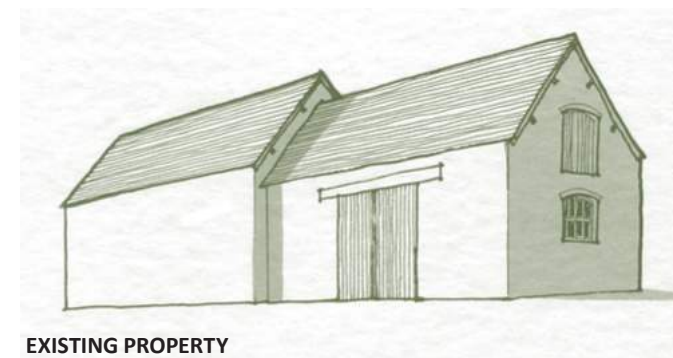

Figure 9.1: Conversion of a traditional farm buildings

# 9. Building conversions

## Reason

9.1.1 Traditional farm buildings either as stand alone building or groupings of buildings can be delightful structures with individual charm and grandeur, yet typically they are simple, straightforward buildings constructed by local workmen with local materials.

9.1.2 Continuation of the original agricultural use is usually most appropriate to preserve the character and appearance of such buildings. However, if a building is no longer needed or suitable for modern agricultural purposes, its disuse can result in the building falling into disrepair. Conversion to an alternative use is a successful way of securing the future of such traditional agricultural buildings.

9.1.3 The amount of alteration necessary to accommodate modern living and working conditions makes conversion difficult whilst retaining those features which give the building, or group of buildings, its distinctive agricultural identity. This normally means that farm buildings cannot be converted for intensive use, and will usually provide fewer residential units or less floor space than would be the case with a new build scheme.

9.1.4 Most farm buildings have unbroken roof slopes, few windows and open interiors which show the roof structure. It is possible to convert farm buildings without changing their character by recognising these principal features and by not seeking to accommodate the maximum floor space. Too many doors and windows, the insertion of dormers, roof lights and chimneys and the alteration or removal of roof trusses will devalue the character of traditional farm buildings and that of the environment.

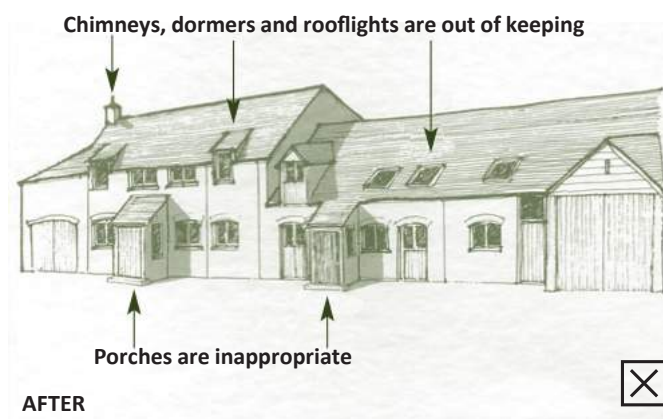
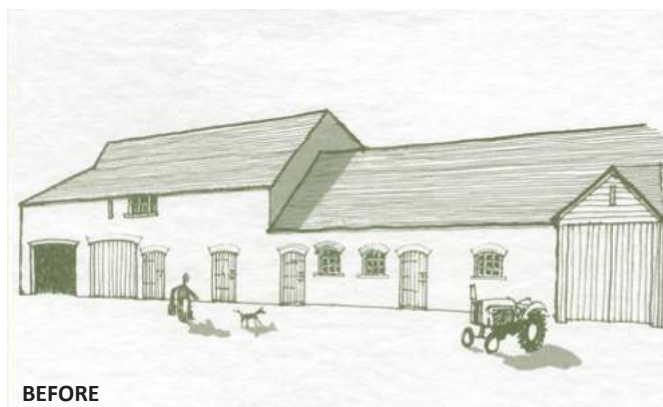

**Figure 9.2: This conversion of a traditional farm building introduces domestic features that detract from the original character**

9.1.5 Applicants should refer to the council's Validation Checklist which provides information on what needs to be submitted as part of a planning application. For conversion of agricultural buildings the council will require applicants to submit a structural report to demonstrate that the building is capable of conversion without substantial rebuilding or extension.

# Agricultural conversions

VALP Policy Ref: C1



**Successful retention of existing openings**



**Domestic style porch and projecting roof lights detract from the barns character**

9.1.6 Some buildings, whether listed or not may be worthy of recording prior to works because of their heritage and/or architectural interest. Applicants should also refer to Historic England advice on the adaption of traditional farm buildings.

# 9. Building conversions

# Agricultural conversions

VALP Policy Ref: C1

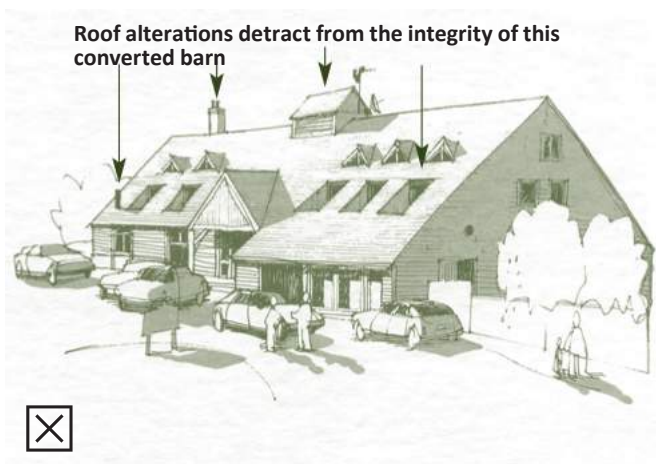

Figure 9.3: This building has lost its agricultural character

## Roofs

9.1.7 The single most important external feature of a traditional farm building is the roof; roofs are seen at a distance and they tend to dominate elevations. Large unbroken roof slopes are a characteristic which should be respected. In order to preserve the original form and appearance of traditional farm buildings it is desirable not to disturb roofs in any way at all.

## Roof lights and dormers

9.1.8 The council is generally opposed to the insertion of roof lights and dormers. Dormers are not usually found on agricultural buildings and even small roof lights catch the eye by reflecting open sky or sunlight. Experience has shown that both dormers and roof lights can be disproportionately responsible for a change in character away from that of a farm building. It is less damaging to disrupt walls than roofs. An alternative may be a suitable opening in the gable end to supplement light levels.

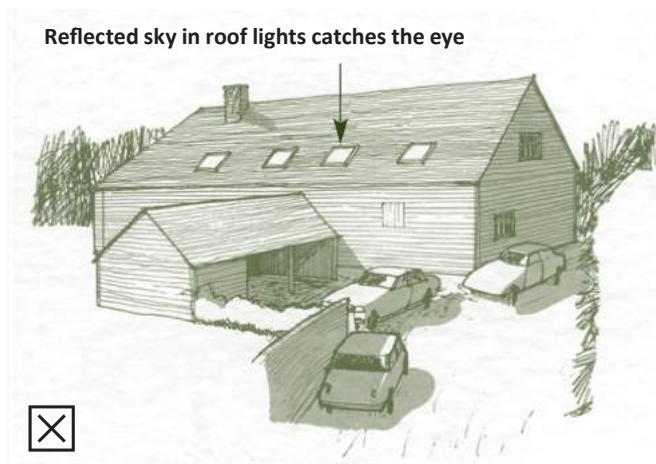
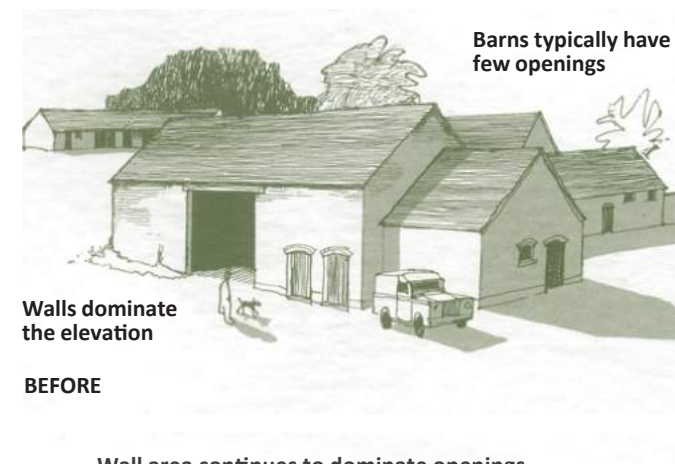

Figure 9.4: Roof lights are discordant features which disrupt roof slopes

9.1.9 Any proposal to form an opening in the roof slope of a traditional farm building will be treated with caution. In special circumstances some alteration of roofs may be allowed but only to a limited degree on less important slopes. Roofs must continue to be overwhelmingly undisrupted and any glazing in the roof slope should hardly be noticeable in an expanse of matt textured tiles or slates.

9.1.10 Normal roof lights have the disadvantage of an upstand which visually jars with the roof profile. Flush fitting roof lights with concealed integral gutters are now available. Also, it is now possible to obtain special non-reflective (Schott) glass to fit into the roof light.

9.1.11 Single storey farm buildings should remain single storey accommodation in order to avoid the need to provide openings in the roof.



BEFORE

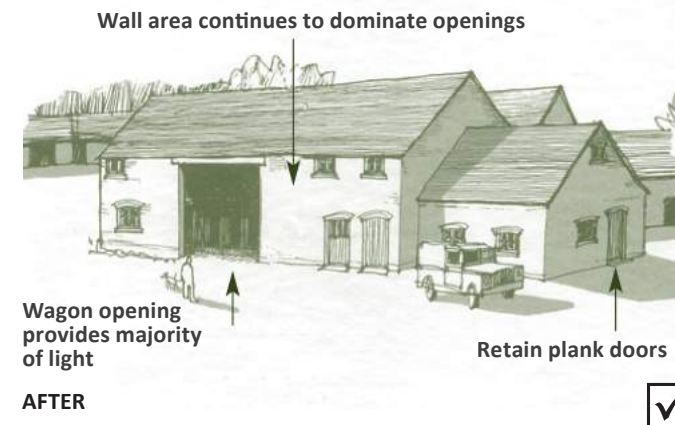

AFTER

Figure 9.5: Conversion responds to the buildings character

## Openings in walls

9.1.12 The simplicity of traditional farm buildings should be retained in any conversion. Agricultural buildings are characterised by a few window and door openings. Conversion to a single dwelling house is generally preferable to the creation of more than one dwelling since this will usually involve fewer new window and door openings.

## 9. Building conversions

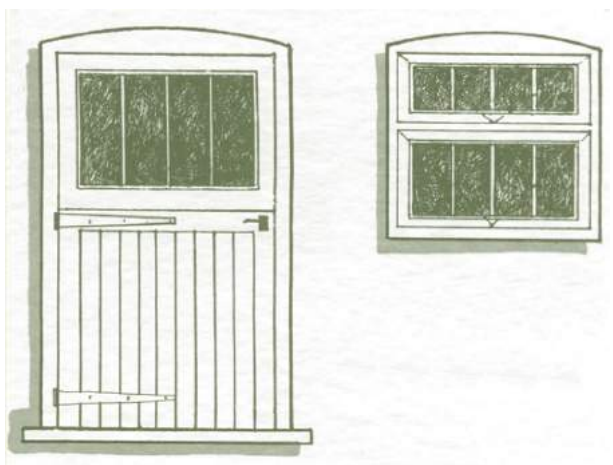

Figure 9.6: Window and door patterns are important in retaining authenticity and should respond to existing types

9.1.13 New window and door openings should preferably be located on 'inside' elevations away from public view. Apart from primary wagon door openings, windows and doors are commonly small and insignificant on agricultural buildings. In conversions, designers will be expected to follow the type, proportion and detail of existing openings.

9.1.14 The position and size of existing openings should also be taken into account when determining the accommodation to be provided within the building. This will affect both the number of rooms that can be formed and the uses to which they are put.

9.1.15 The re-use of existing openings, existing doors and window frames is encouraged. Any additional doors and windows should copy existing patterns. Large wagon door openings should be used to provide the majority of internal natural light by constructing an inconspicuous frame set back into the building.

### Materials

9.1.16 Rebuilding should be avoided, as much of the original fabric should be retained as possible. Where rebuilding is inevitable then existing materials should be re-used. When modern materials are used for repair or rebuilding they are invariably obvious and immediately noticeable. In order to maintain converted farm buildings in an authentic condition new work should blend harmoniously with old. Replica slates and tiles, reconstituted stone, concrete, aluminium and plastic are unacceptable materials.

### Mortar mix

9.1.17 Pointing should be flush or slightly recessed and not proud of the wall surface. Applicants should not attempt to make a feature of the pointing; brush pointing is better than a mechanically smooth finish. Lime should be used in the mortar mix to allow movement, it will also help to match the colour of the mortar with the original. Cement coloured mortars are to be avoided and care should be taken not to smudge the face of stone or brickwork.

### Timber

9.1.18 Timber frames should be preserved as completely as possible, scarfing new timber to old is preferred rather than replacement. Roof trusses should remain unaltered and if possible visible. Rough sawn boarding used to clad farm buildings should be of traditional size (225mm with 37mm overlap) and not smooth profiled modern types (usually 150mm or less). Wood types should be matched. Oak is normally used for structural elements and tar coated elm for weatherboards.

## Agricultural conversions

VALP Policy Ref: C1

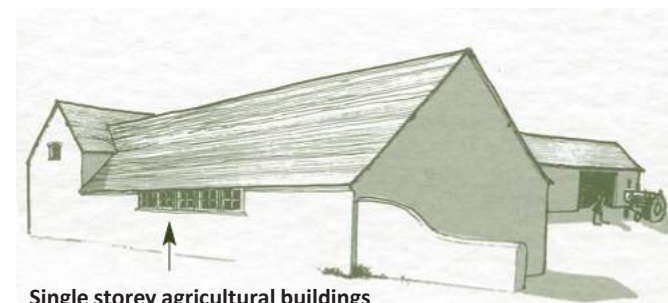

Single storey agricultural buildings are often of a linear shape - a ribbon window of traditional pattern can be appropriate

Figure 9.7: Window design responds to building character

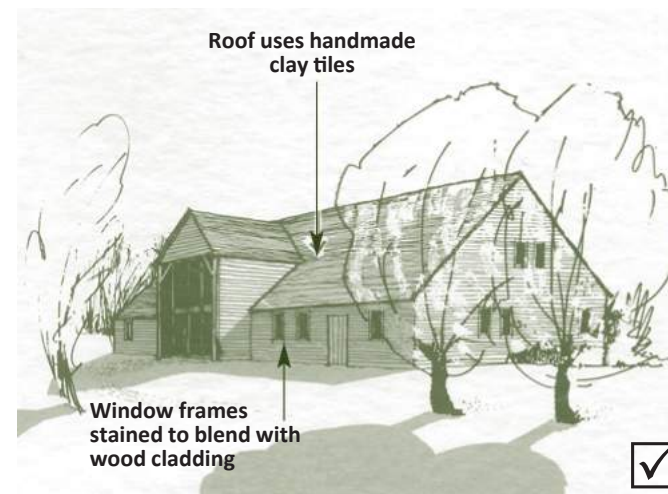

Figure 9.8: Materials used in the conversion respond to the traditional building

## 9. Building conversions

## Agricultural conversions

VALP Policy Ref: C1

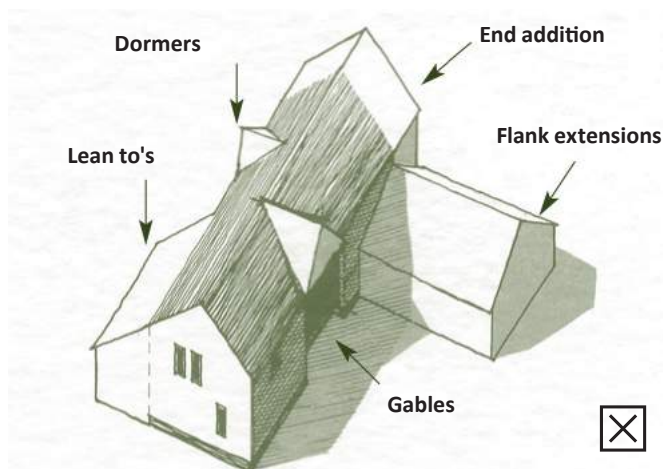

Figure 9.9: Extensions to the original building will normally be resisted

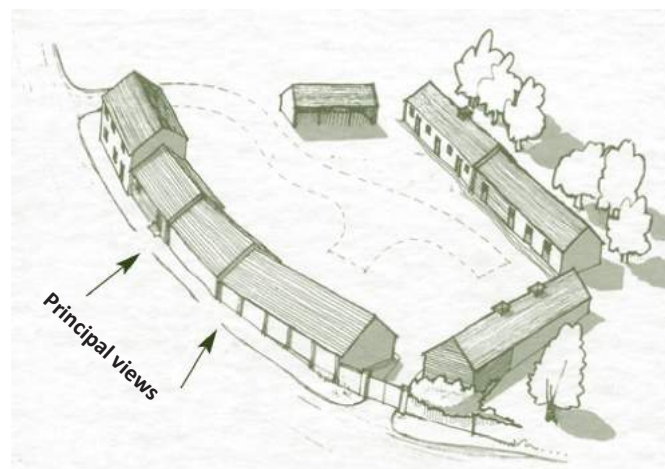

Figure 9.10: Alteration of principal elevations will also normally be resisted

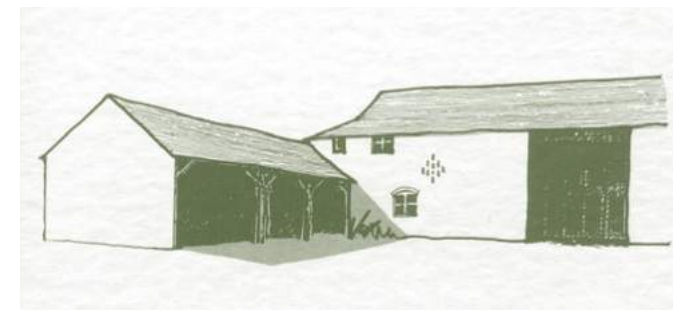

Figure 9.11: Where appropriate outbuildings should be part of conversion schemes

### Extensions and additions

9.1.19 Farm buildings are operational structures, generally without ornament or symmetry. They have a functional simplicity which is part of their appeal. Changes to the roof slope, amendments to the eaves line and the addition of porches will contribute to complexity and a loss of original character. It is important that farm buildings are preserved in their original form without alien additions or alterations.

### Rainwater goods

9.1.20 Rain was often allowed to run off the eaves of farm buildings without a roof drainage system. It follows that new rainwater gutters and downpipes should be discrete and mounted using stirrup brackets rather than a fascia board. Rainwater downpipes should be minimised on less prominent elevations where possible and made of metal (preferably in a traditional design) rather than plastic.

### Chimney stacks

9.1.21 The addition of chimney stacks can change the agricultural appearance of farm buildings by creating a domestic image. Where no chimney exists then a small metal flue finished in black or dark grey will be acceptable provided that it is set away from prominent facades or otherwise located inconspicuously.

### Heating

9.1.22 The use of conventional central heating causes movement in timber framed buildings, due to the high surface temperatures of radiators. Underfloor, low temperature heating or fan convector heaters are kinder to timber flooring which have been exposed to ambient weather conditions for years. Specialist heating engineers or consultants will be required to advise on installation and maintenance.

### Interiors

9.1.23 Design solutions will have to be found which avoid disturbing the existing roof timbers and which do not require raising external walls. Conversion work needs special skill and consulting designers who have a proven record of success in this field is recommended.

9.1.24 Traditional farm buildings will most effectively retain their integrity if the interior is left open, or at least in part, to give an impression of the pre-converted space. Open plan designs within which the roof structure can be appreciated from the ground floor are preferred. Open layouts help natural light penetrate from a limited number of openings to illuminate a relatively large area of floor space.

9.1.25 Internal divisions should be kept to a minimum and in sympathy with the structural bay divisions of the building. Where appropriate staircases and doors should be contemporary in design. The removal, cutting through or disturbing of framing members should be resisted, new walls and partitions should avoid encasing the frame and, where necessary, a colourless fire resisting coating should be applied directly.

## 9. Building conversions

### Principle DES66: The curtilage of an agricultural conversion should respond to its' rural context

Consideration must be given to the curtilage of the agricultural conversion. Traditional farm buildings are generally associated with yards or open field locations. In order to maintain the agricultural character of converted buildings in their new use, they should retain their open setting and relationship with the countryside. Traditional materials that are contextual with the farm buildings should be used including stone setts, clay bricks or gravel and avoiding tarmac or concrete blocks or paving. Existing trees and plants should be retained where possible and new planting should generally be native species.

Car parking should be concealed wherever possible and existing ancillary buildings should be used as garaging to avoid the need for new buildings. Conversions should not subdivide historic farmyards.

Landscaping and boundary treatments need careful attention and should be designed to be as simple as possible. Hard and soft landscaping should be kept informal, and walls, fences, kerbing and any other urban features should be avoided where they would harm the building's agricultural character or farmyard setting.

### Reason

9.1.26 Farm buildings are simple and unfussy, suburban paraphernalia (patio equipment, interwoven fencing, greenhouses, pools and sheds) can detract from their farm like setting. The curtilage of a converted farm building should remain open and uncluttered.

9.1.27 There may be scope for private areas but these should be screened with hedging and walls of old brick. The treatment of boundaries should reflect the building's rural character, post and rail fences, timber gates of the five bar type or hedgerows will be encouraged.

9.1.28 Cars and other vehicles detract from the appearance of farm yards causing them to look domestic. Parking and garaging should be concealed as far as possible. The council will expect that existing cart sheds should be re-used to garage vehicles provided that access arrangements are suitable for modern requirements. The council is reluctant to accept new structures for garaging when suitable accommodation for vehicles exists, not all buildings will therefore be available for residential conversion.

9.1.29 Buildings and structures that predate July 1948 and are within the curtilage of a listed building are treated as part of the listed building. Refer to Historic England Advice Note 10 Listed Buildings and Curtilage which provides a range of hypothetical case studies to illustrate what might be considered to be the curtilage of a listed building.

## Agricultural conversions

VALP Policy Ref: C1

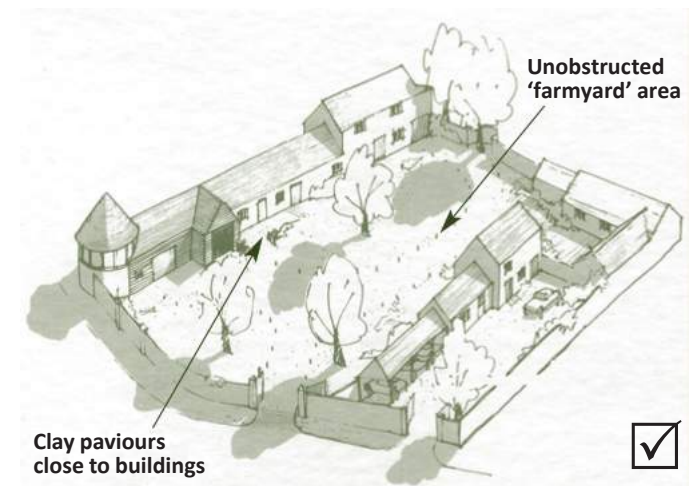

Figure 9.12: Spaces within farm groups should remain uncluttered

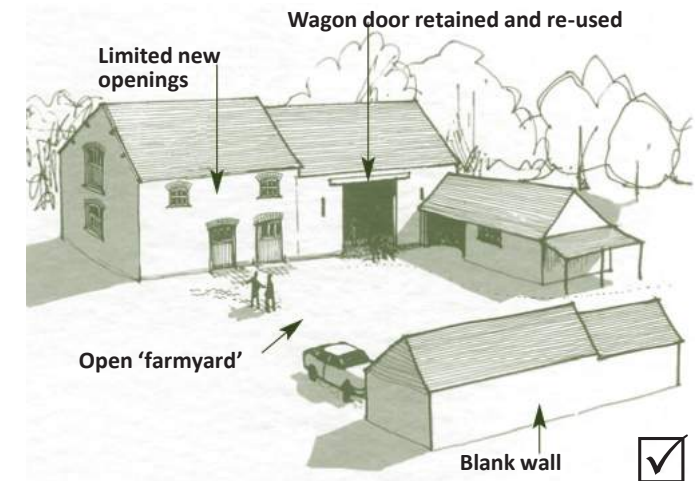

Figure 9.13: Converted farm buildings should retain their agricultural appearance

# 9. Building conversions

# Agricultural conversions

VALP Policy Ref: C1

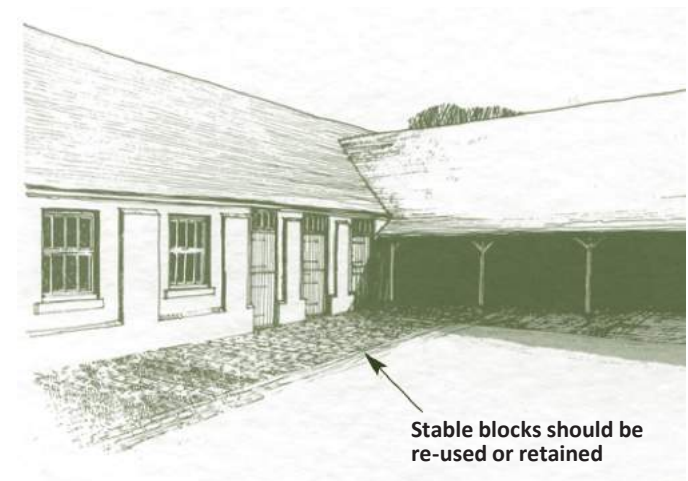
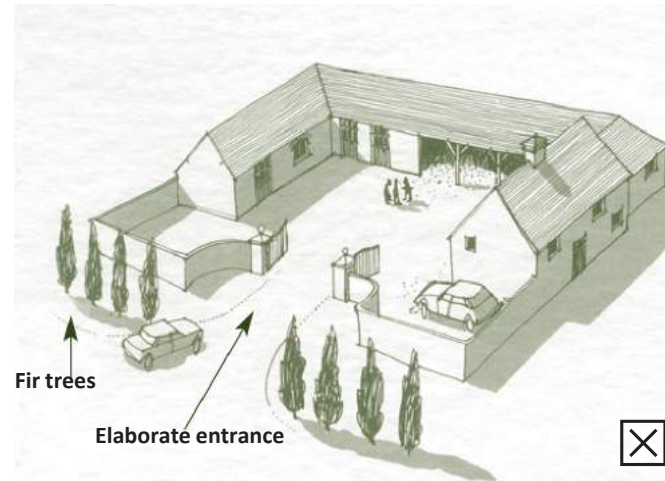
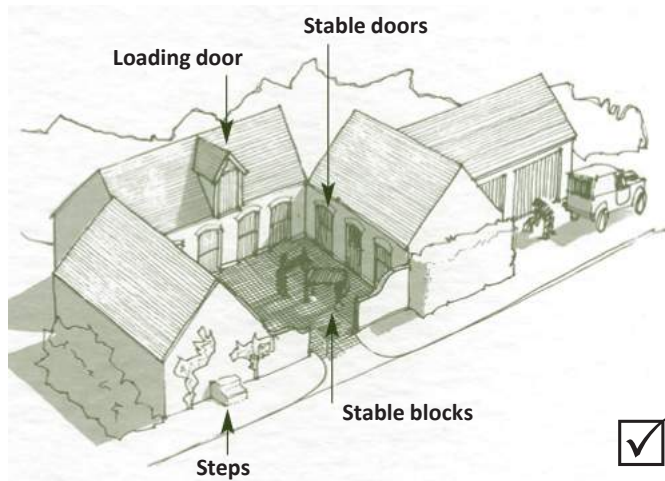

Figure 9.14: Existing features on buildings and in space that give character should be retained

Figure 9.15: Farms would not originally have prestigious entrances of non-indigenous trees and these feel out of place

Figure 9.16: Open cart sheds should be used for car parking and not converted for residential use



# 9. Building conversions

## 9.2 Conversion of chapels, schools and churches

### Principle DES67: Conversion of chapels, schools and churches

The primary objective of all conversions of chapels, schools and churches must be to retain the character appearance and heritage significance of the original building.

Where conversion to residential uses is proposed this may require compromises in terms of the residential layout and the provision of natural light into all habitable rooms.

The introduction of conspicuous domestic features such as chimneys, satellite dishes, aerials, porches and additional window or door openings tend to be out of character with the original building and, wherever possible, such features should be avoided.

Existing openings in elevations should be used for windows and doors and a simple window design is usually most appropriate.

The internal wall divisions should be retained wherever possible and the introduction of additional walls or floors should be kept to a minimum. Existing window openings and window detailing, such as stained glass, should be retained and refurbished.

When converting a building to domestic use it is important that the design and materials used enable sufficient noise insulation. This is particularly important when a building conversion creates a mix

of domestic and commercial uses in close proximity.

Where additional floors are introduced, they should not cut across tall windows in such a way as to be visible from outside the building or significantly affect the spatial qualities.

Large extensions or ancillary buildings are not usually appropriate for conversions. Such elements can dominate the original building and so detract from its character.

Any existing ecclesiastical fixtures and fittings should be retained wherever possible, and the inclusion of additional detailing which would detract from the character of the building should be avoided.

Landscaping and boundary treatments should be designed to be as simple as possible.

Paint colours and finishes should be chosen to reflect the character and appearance of the building.

Chapel, school and church buildings can support protected species such as bats and barn owls. Bats and their roost sites are highly protected under the Wildlife and Countryside Act 1981 (as amended) and The Conservation of Habitats and Species Regulations 2017. Barn owls are protected against disturbance whilst they are nesting. Applications will need to be supported by appropriate surveys

## School + church conversions



Internal floor division is visible through window



Residential conversions of former school

## 9. Building conversions

### Reason

9.2.1 Similar to agricultural conversions, the design challenges associated with the conversion of these buildings often relate to the creation of room and floor divisions in buildings which originally comprised large internal spaces.

9.2.2 The defining characteristics of chapels, schools and churches are often similar, comprising formal proportions and a simple rectangular footprint, tall sash windows, brick or stone arches, uninterrupted roof slopes, long ridge lines, and large internal spaces, sometimes with mezzanine floors. Architectural detailing may include stained glass windows, ornate timberwork and plasterwork on walls and ceilings, and ecclesiastical memorials. These features are essential to the building's character and, therefore, need to be retained as part of the proposed conversion.

9.2.3 Chapels, schools and churches are typically located in central village locations. The buildings often include limited external space as part of the site, which can present a challenge in terms of providing amenity space and minimising any overlooking of neighbouring dwellings for residential conversion.



Entrance to nursery is not designed to be respectful of the historic chapel

## School + church conversions



Successful retention of feature windows

# 9. Building conversions

## 9.3 Commercial building conversions

### Principle DES68: Conversion of commercial buildings

The primary objective for conversion of historic commercial buildings must be to retain the character, appearance and heritage significance of the original building. For conversion of office buildings to residential uses the objective is to deliver a building that has architectural integrity and to provide acceptable homes for future residents.

Where conversion to residential uses is proposed this may require compromises in terms of the residential layout and the provision of natural light into all habitable rooms. Office buildings are typically deeper plan than residential buildings and rely on artificial lighting and air conditioning for ventilation; developers should demonstrate how these issues may be overcome in the design of the conversion.

The introduction of conspicuous domestic features such as chimneys, satellite dishes, aerials, porches and additional window or door openings may be out of character with the original building and, wherever possible, such features should be avoided. If additional light is required, it may be appropriate to introduce glass roof tiles or appropriately designed rooflights.

For historic conversions internal walls should be retained and the introduction of additional walls or floors should be kept to a minimum. Existing window openings and detailing should be retained. Where additional floors or mezzanines are introduced, they should not be visible through windows. For conversion of office buildings internal layout should relate to the fenestration.

When converting a building to domestic use it is important that the design and materials used enable sufficient noise insulation. This is particularly important when a building conversion creates a mix of domestic and commercial uses in close proximity.

Large extensions or ancillary buildings are not usually appropriate for historic conversions. Such elements can dominate the original building and so detract from its character. Wherever possible, existing ancillary buildings such as storage sheds should be used as garaging to avoid the need for new buildings

Existing commercial or industrial fixtures and fittings should be retained wherever possible. Original features such as internal metalwork can make a positive contribution to the final scheme. The introduction of additional detailing, which would detract from the character of the building, should be avoided.

Landscaping and boundary treatments need careful attention and should be designed to be as simple as possible and should respond to the character and materials of the building being converted. Walls and fences should be avoided where they would harm the building's character or setting.

Commercial buildings can support protected species such as bats or birds. Bats and their roost sites are highly protected under the Wildlife and Countryside Act 1981 (as amended) and The Conservation of Habitats and Species Regulations 2017. Applications will need to be supported by appropriate surveys

## Commercial conversions



Former warehouse building in Buckingham converted to residential use

# 9. Building conversions

## Commercial conversions

### Reason

9.3.1 Commercial buildings in Aylesbury Vale include shops, pubs, mills and warehouses. In Aylesbury town centre there are also former office buildings and some of these have been converted from office to residential often through permitted development rights.

9.3.2 These larger buildings are often converted into self-contained flats which have additional amenity, parking and storage requirements that should be considered at the outset of the design process.

9.3.3 Where a property is being converted to flats, the development should, where possible, be contained within the existing building envelope. If extensions are necessary, for example to accommodate a lift or to meet building regulations, proposals need to be carefully designed.

9.3.4 Whilst pubs and shops usually have a domestic scale and design, industrial buildings such as warehouses are usually much larger, with a more formal architectural composition.

9.3.5 The defining characteristics of these industrial buildings include formal proportions usually in a rectangular plan, and large windows (i.e. plate glass in iron frames with top-hinged openings, small pane timber sash windows or Crittall windows).

9.3.6 For office to residential conversions it is important to maintain a simple architectural formality through the pattern of window openings and where possible to introduce a vertical rhythm to the facade.



Conversion of Ringwood House, Aylesbury, from office to residential use. The conversion remodels the entrance and gives the building a contemporary feel



Conversion of Ringwood House, Aylesbury, from office to residential use - car parking is within an undercroft where it is hidden from the street

### How to use

This table provides a checklist for use by both the applicant and planning officer to check that appropriate consideration has been given to the design of a **building conversion** as part of an application.

**PROCESS:** Have you read, understood and applied the principles set out above?

The adjacent table summarises the key principles set out within this section and can be used by applicant and officer as a checklist.

**Applicants will be expected to demonstrate to the Council that they have responded adequately to all relevant principles in preparing their proposals, or provide a justification for any failure to do so.**

Principle	Description	Check
<b>DES65: Agricultural buildings</b>	Has a structural report been submitted with any planning application to demonstrate that the building is capable of conversion without substantial rebuilding or extension? If substantial rebuilding or extension is required, it is unlikely that planning permission will be granted as the proposed works would no longer constitute a conversion.	
	Does the conversion retain the character and appearance of the original building as established in the Character Study? The introduction of conspicuous domestic features should be avoided.	
	Has the conversion used the existing openings in elevations for windows and doors? New windows or doors should be added sparingly and should not significantly alter the overall proportion of solid wall to openings. A simple window design is usually most appropriate.	
<b>DES66: Curtilage of agricultural building</b>	Does the curtilage of the agricultural building respond to its context? Do the landscape, boundary treatments and access roads reflect the agricultural character of a farmyard setting?	
<b>DES67: Chapels, schools and churches</b>	Does the conversion retain the character and appearance of the original building as established in the Character Study? The introduction of conspicuous domestic features should be avoided.	
	Has the conversion used the existing openings in elevations for windows and doors? New windows or doors should be added sparingly and should not significantly alter the overall proportion of solid wall to openings. A simple window design is usually most appropriate.	
	If additional floors are introduced, do they avoid cutting across tall windows?	
	Are existing ecclesiastical fixtures and fittings retained wherever possible?	
	Does the curtilage of the building respond to its context? Is the landscape and boundary treatments designed in a simple manner that does not detract from the building?	
<b>DES68: Commercial buildings</b>	Does the conversion retain the character and appearance of the original building (where appropriate) as established in the Character Study? The introduction of conspicuous domestic features should be avoided. Where this is not appropriate has the building been designed with architectural integrity (refer also to Principle DG38)	
	Has the conversion used the existing openings in elevations for windows and doors? New windows or doors should be added sparingly and should not significantly alter the overall proportion of solid wall to openings. A simple window design is usually most appropriate.	
	Are existing commercial or industrial fixtures and fittings retained where appropriate?	
	Does the curtilage of the building respond to its context? Is the landscape and boundary treatment designed in a simple manner and in keeping with the industrial or commercial aesthetic?	
<b>All Conversions</b>	Has a survey been carried out to assess the presence of bats or birds?	



# Appendix A National Design Guide



This page is intentionally left blank



### Design Principles and the National Design Guide

A.1 In October 2019 the Government published the National Design Guide in order to illustrate how well-designed places that are beautiful, enduring and successful can be achieved in practice. It outlines this in the form of ten characteristics that contribute to good design. The National Design Guide recognises, however, that specific, detailed and measurable criteria for good design are most appropriately set out at the local level.

A.2 The National Design Guide addresses the question of how we recognise well-designed places, by outlining and illustrating the Government's priorities for well-designed places in the form of ten characteristics. These are listed below and indicated in the diagram in Figure A.1.

- 1 **Context** – enhances the surroundings.
- 2 **Identity** – attractive and distinctive.
- 3 **Built form** – a coherent pattern of development.
- 4 **Movement** – accessible and easy to move around.
- 5 **Nature** – enhanced and optimised.
- 6 **Public spaces** – safe, social and inclusive.
- 7 **Uses** – mixed and integrated.
- 8 **Homes and buildings** – functional, healthy and sustainable.
- 9 **Resources** – efficient and resilient.
- 10 **Lifespan** – made to last.

A.3 In January 2021 the Government launched the National Model Design Code to provide detailed guidance on the production of design codes, guides and policies to promote successful design. This was republished in two parts - part 1 - the coding process and part 2 - guidance notes in July 2021.

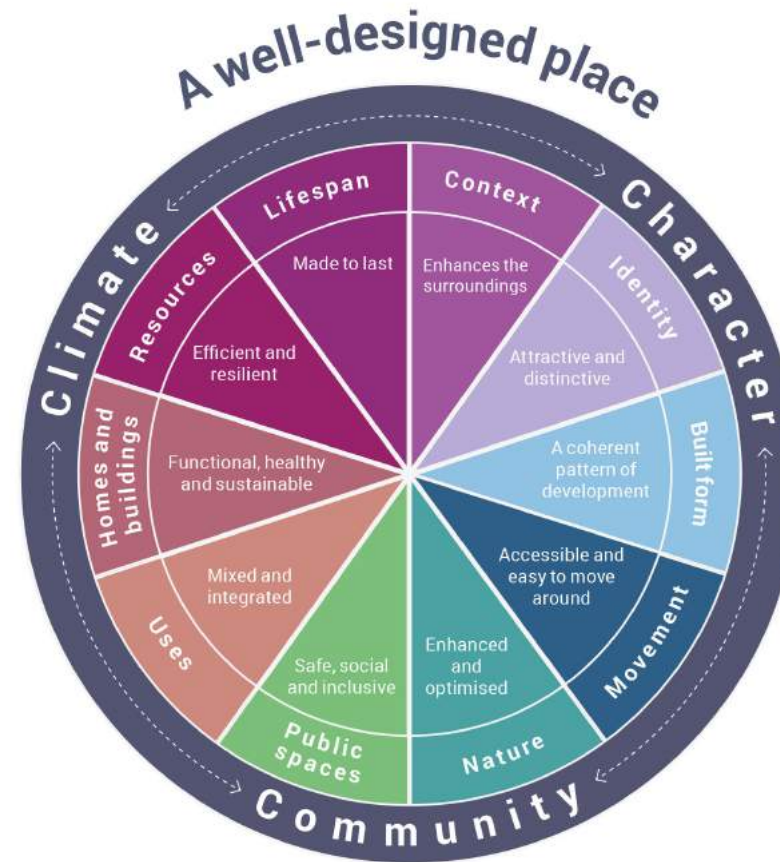

Figure A.1: The ten characteristics of a well designed place (National Design Guide 2019)

A.4 The Design SPD draws on the National Design Guide and National Model Design Code through its recommendations. Figures 1.2 to 1.6 within Chapter 1 provides a list of all of the design principles and indicates the National Design Guide design characteristics that each design principle relates to.



# Appendix B

## Landscape character typologies

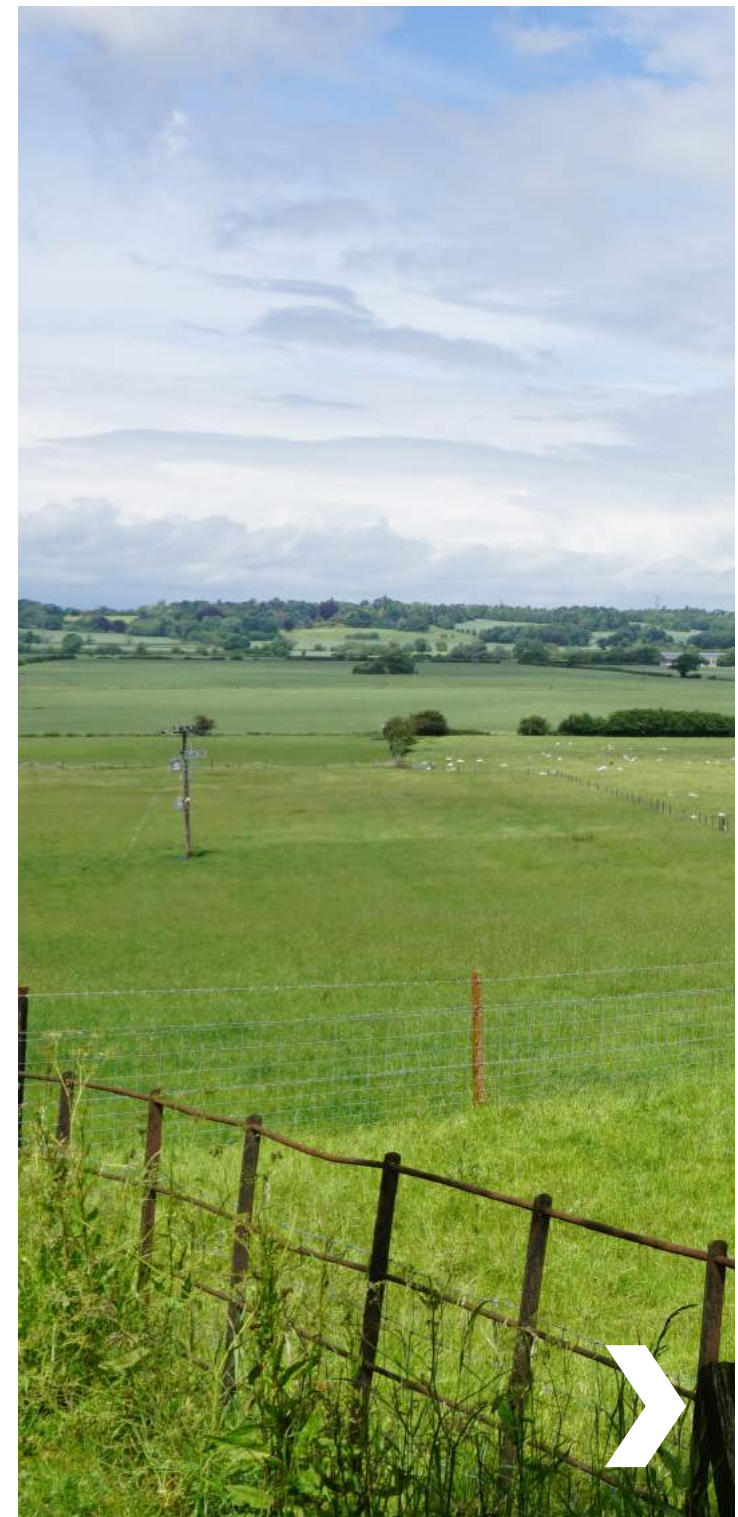

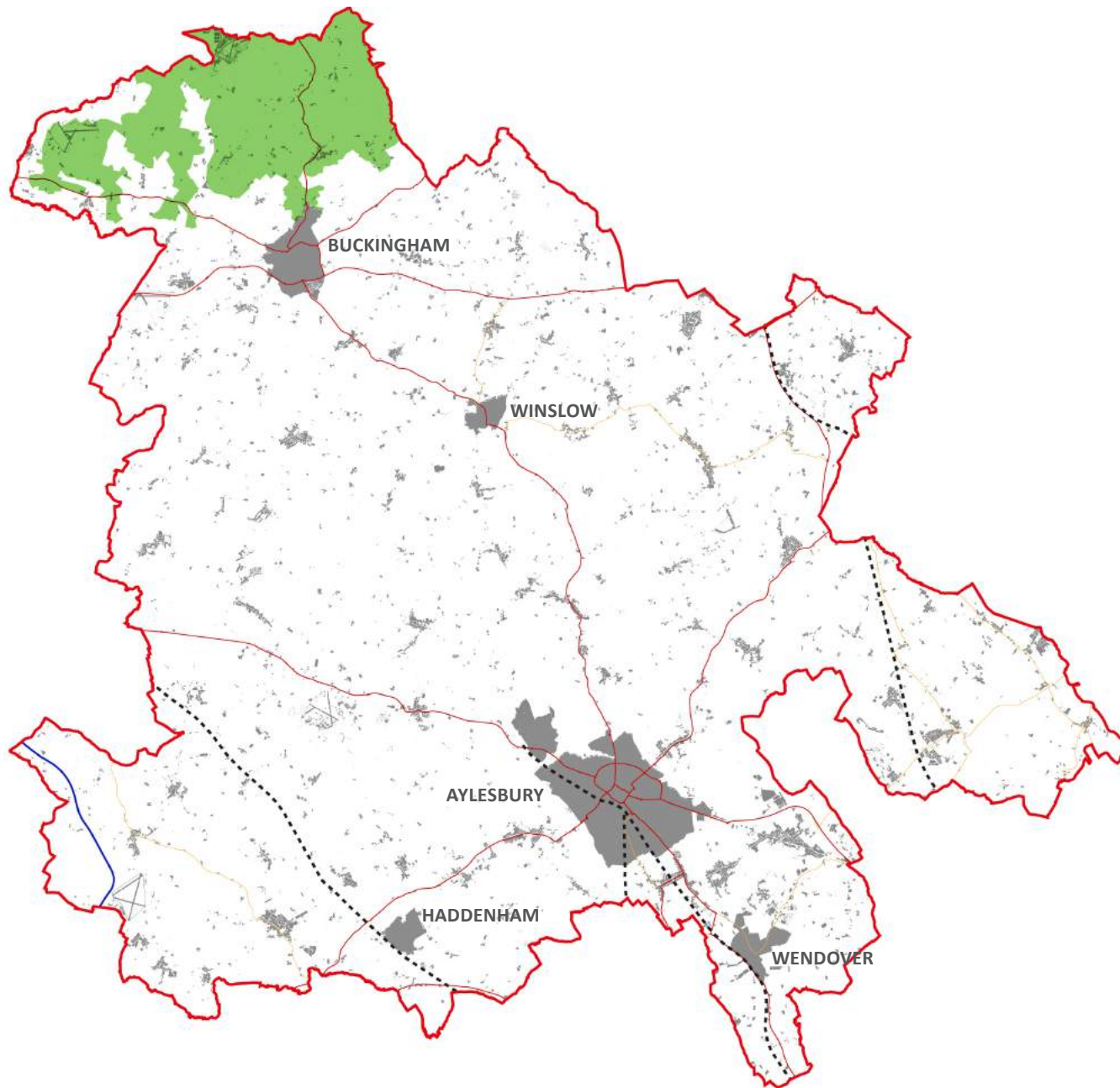

Typology	LCT 01: Wooded Ridge
<b>Landform and views</b>	A broad and gently undulating ridge which lacks dramatic landform, however incised valleys mark the plateau margins. Views are generally contained by woodland.
<b>Vegetation</b>	Coniferous and broad-leaved woodland give dense land coverage. Ancient woodland blocks and a strong hedgerow pattern with mature oak trees sit alongside this.
<b>Settlement and materials</b>	The dispersed settlement pattern and meandering lanes add to the tranquil character. Local vernacular and traditional building materials of limestone, timber and predominantly red brick.
<b>Settlements within area</b>	Towns: Buckingham (northern edge). Medium and small villages: Akeley, Maids Moreton, and Stowe and Dadford.

Figure B.1: Landscape character typology LCT01: Wooded Ridge

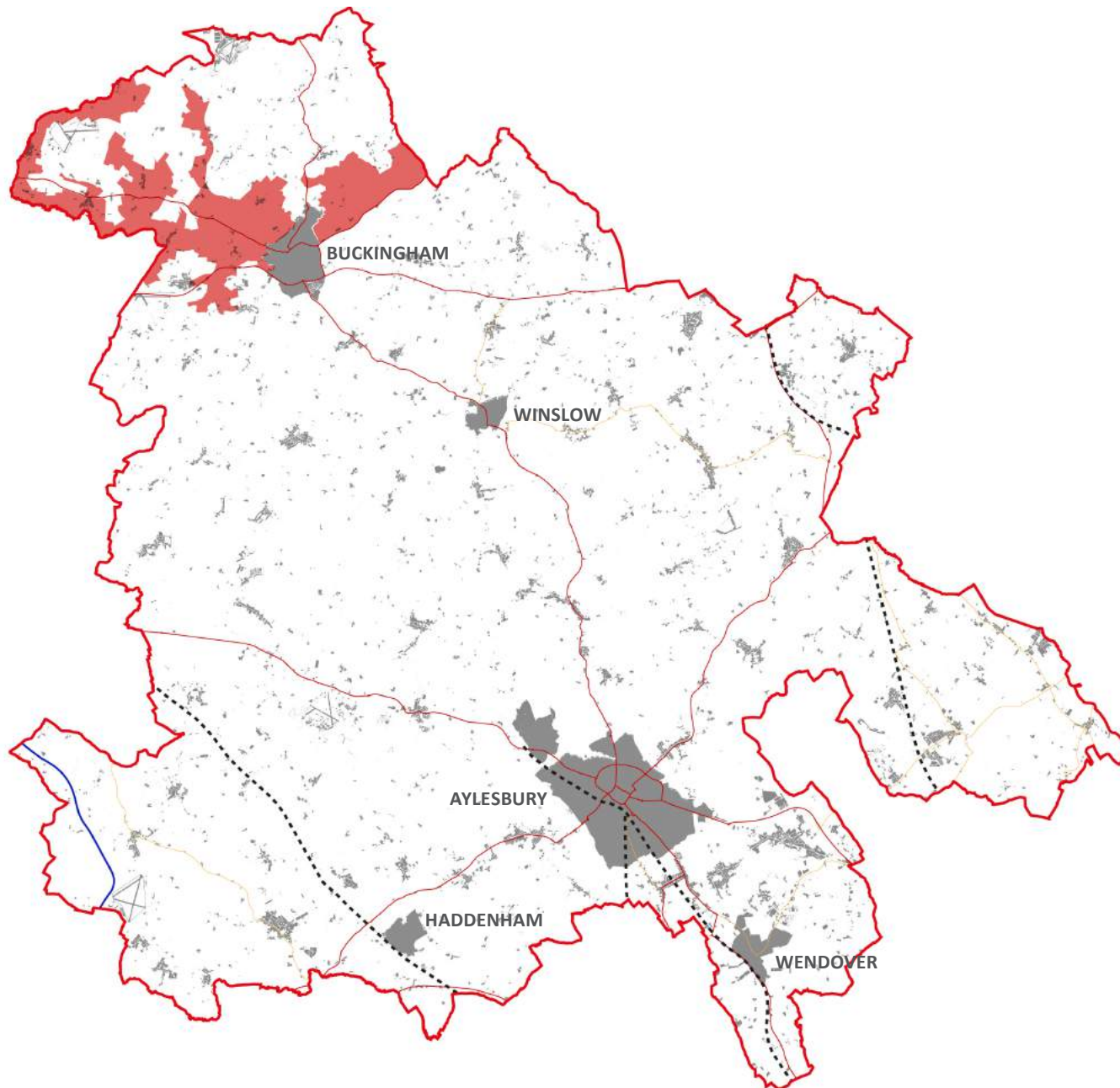

Typology	LCT 02: Incised Valleys
<b>Landform and views</b>	Small, steep and narrow valleys created from the incision of the Great Ouse. Landform limits views and visual detractors arise from main roads and arable farming.
<b>Vegetation</b>	Ecological interest is created from the base-rich ferruginous fens and scattered woodland. Oak and some ash dominate alongside ground flora typical to ancient woodland.
<b>Settlement and materials</b>	Historic settlement in traditional materials of limestone, timber and red brick, and field pattern, including isolated farmsteads, is focused along the Great Ouse river before dispersing up-slope as arable farming becomes the dominant land use.
<b>Settlements within area</b>	Towns: Buckingham (western and eastern edges)  Medium and small villages: Chackmore, Turweston and Westbury.

Figure B.2: Landscape character typology LCT02: Incised Valleys

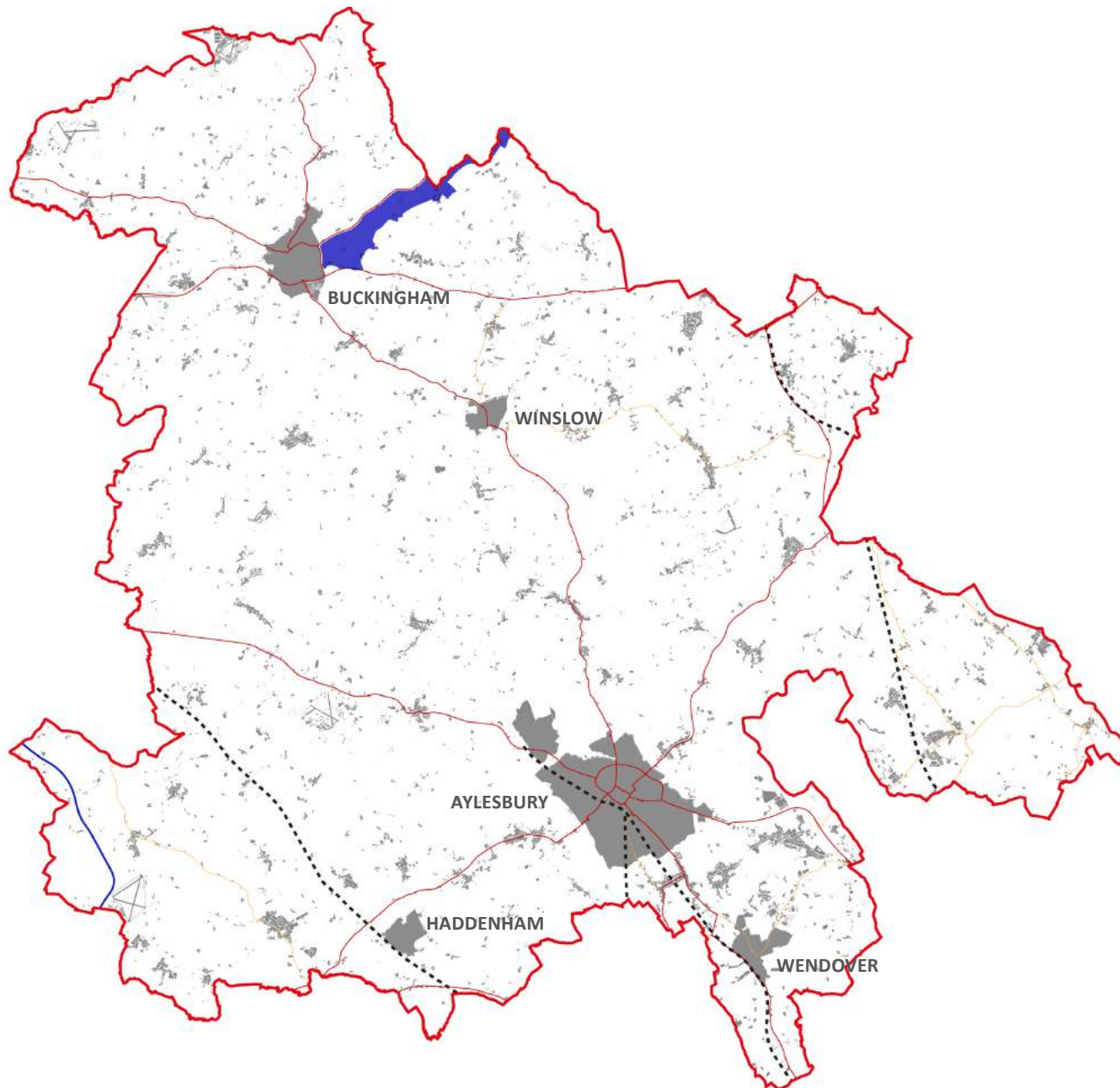

Typology	LCT 03: Valley Bottom
<b>Landform and views</b>	The wide floodplain straddling the Great Ouse is coupled with gently sloping topography. Views are generally constrained by landform, and pylons and roads act as visual detractors.
<b>Vegetation</b>	Great biological interest is found within bankside vegetation, wetland trees, shrubs, grasses, reeds and small woodland pockets. Distinctive willows overhang the meandering river.
<b>Settlement and materials</b>	Intimate and enclosed landscapes exist along the river, turning to large-scale arable farming further up the valley sides. The low density of typically red brick and timber settlement includes traditional weirs and mills.
<b>Settlements within area</b>	N/A

Figure B.3: Landscape character typology LCT03: Valley Bottom

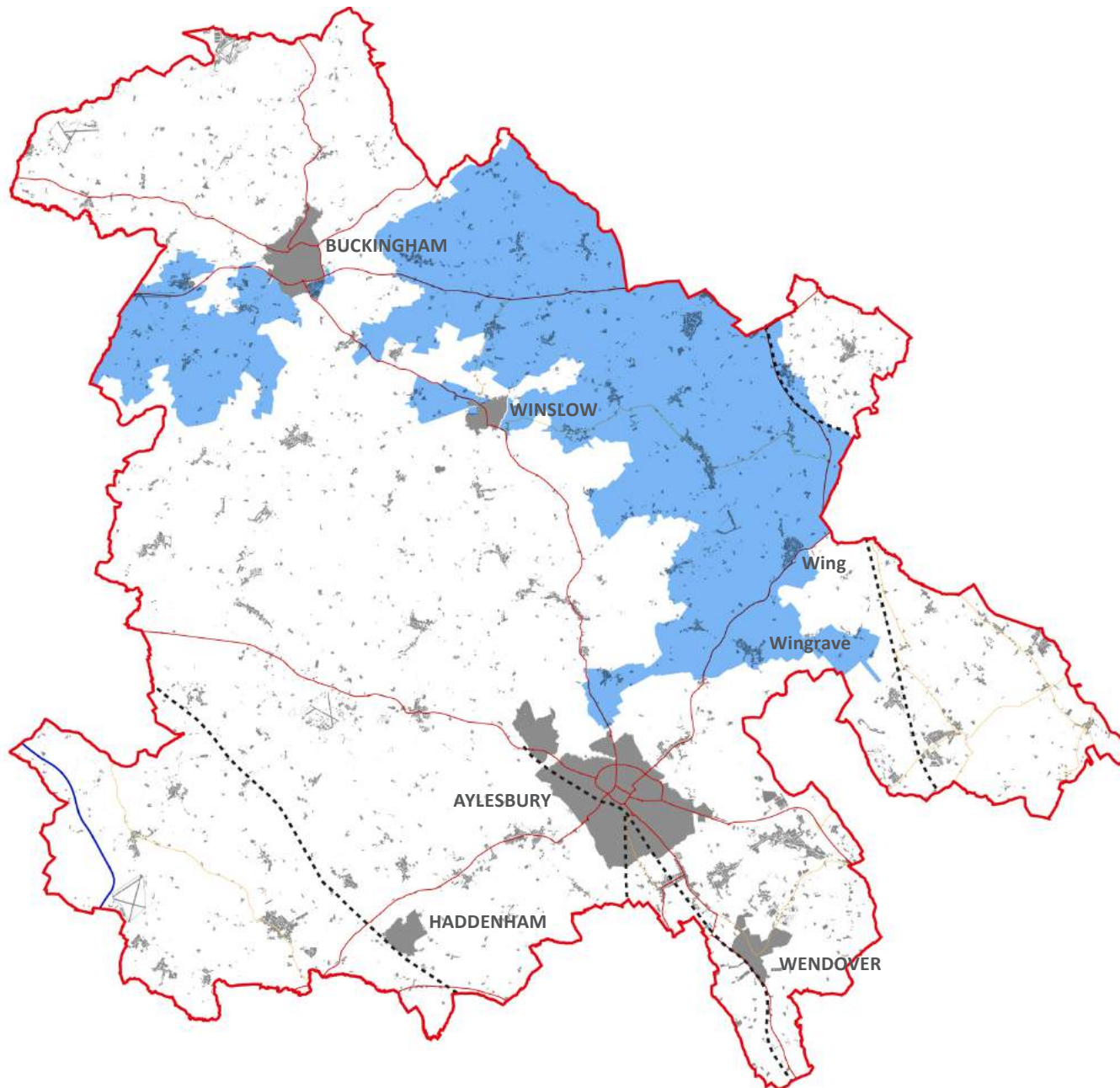
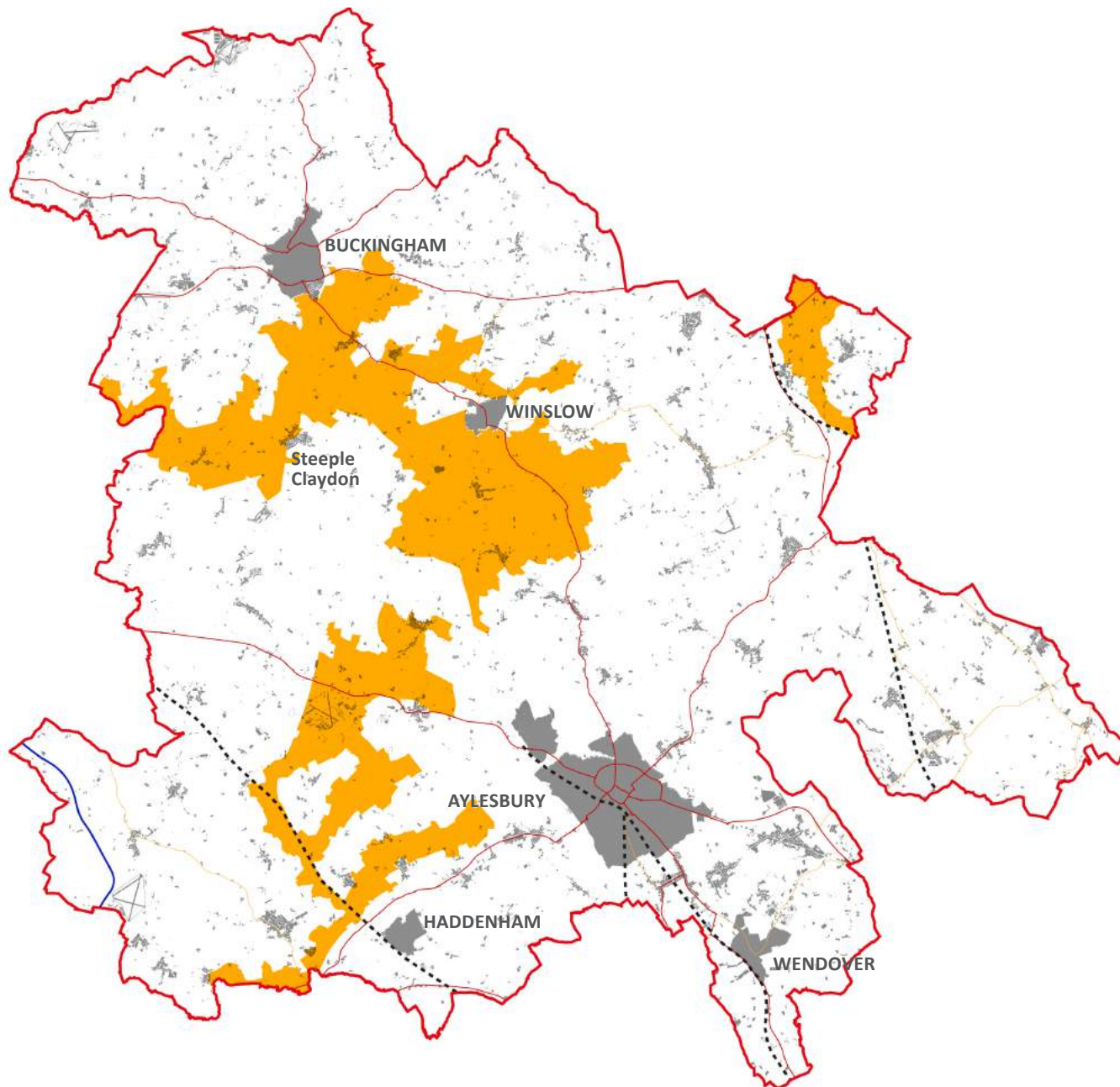

Figure B.4: Landscape character typology LCT04: Undulating Clay Plateau

Typology	LCT 04: Undulating Clay Plateau
<b>Landform and views</b>	The rolling landform of the clay plateau is shaped by a series of shallow rides and valleys. Views within the LCT are contained by landform; however the plateau margins provide extensive vistas.
<b>Vegetation</b>	Many fen sites comprise a variety of herb and grass species. Woodland blocks in the north contain a large proportion of ancient woodland and clipped hedges are dominated by oak and ash trees.
<b>Settlement and materials</b>	Historic villages which are accessed by winding lanes. The landscape structure is enhanced by the vernacular buildings which use a variety of materials including timber, brick and thatch.
<b>Settlements within area</b>	Towns: Buckingham (south western edge), and Winslow (east and west). Large villages: Wing and Wingrave. Medium and small villages: Aston Abbots, Beachampton, Cublington, Drayton Parslow, Gawcott, Great Horwood, Little Horwood, Mursley, Nash, Newton Longville, Preston Bissett, Soulbury, Stewkley, Stoke Hammond, Swanbourne, Thornborough, Tingewick, Weedon and Whaddon.



Typology	LCT 05: Shallow Valleys
<b>Landform and views</b>	Shallow and poorly defined valleys incise the gently sloping or flat landscape, giving limited views over the LCT. Significant visual detractors come from the network of pylons and the railway.
<b>Vegetation</b>	Biodiversity interest predominantly comes from the river corridor. Pollarded willows and black poplars are important local tree species. Grassland cover dominates with strong hedgerow pattern. Woodland is sparse.
<b>Settlement and materials</b>	Overall lack of settlement, however some well-preserved, historic, nucleated villages are limited to marginally higher ground. Buildings often limestone, red brick or rendered. Limited road access is coupled with historic and industrial relics, resulting in a remote and tranquil area.
<b>Settlements within area</b>	Towns: Buckingham (southern edge), and Winslow (north and south).  Large Villages: Steeple Claydon (north).  Medium and small villages: Adstock, Granborough, North Marston, Padbury, Quinton, Twyford and Westcott.

Figure B.5: Landscape character typology LCT05: Shallow Valleys



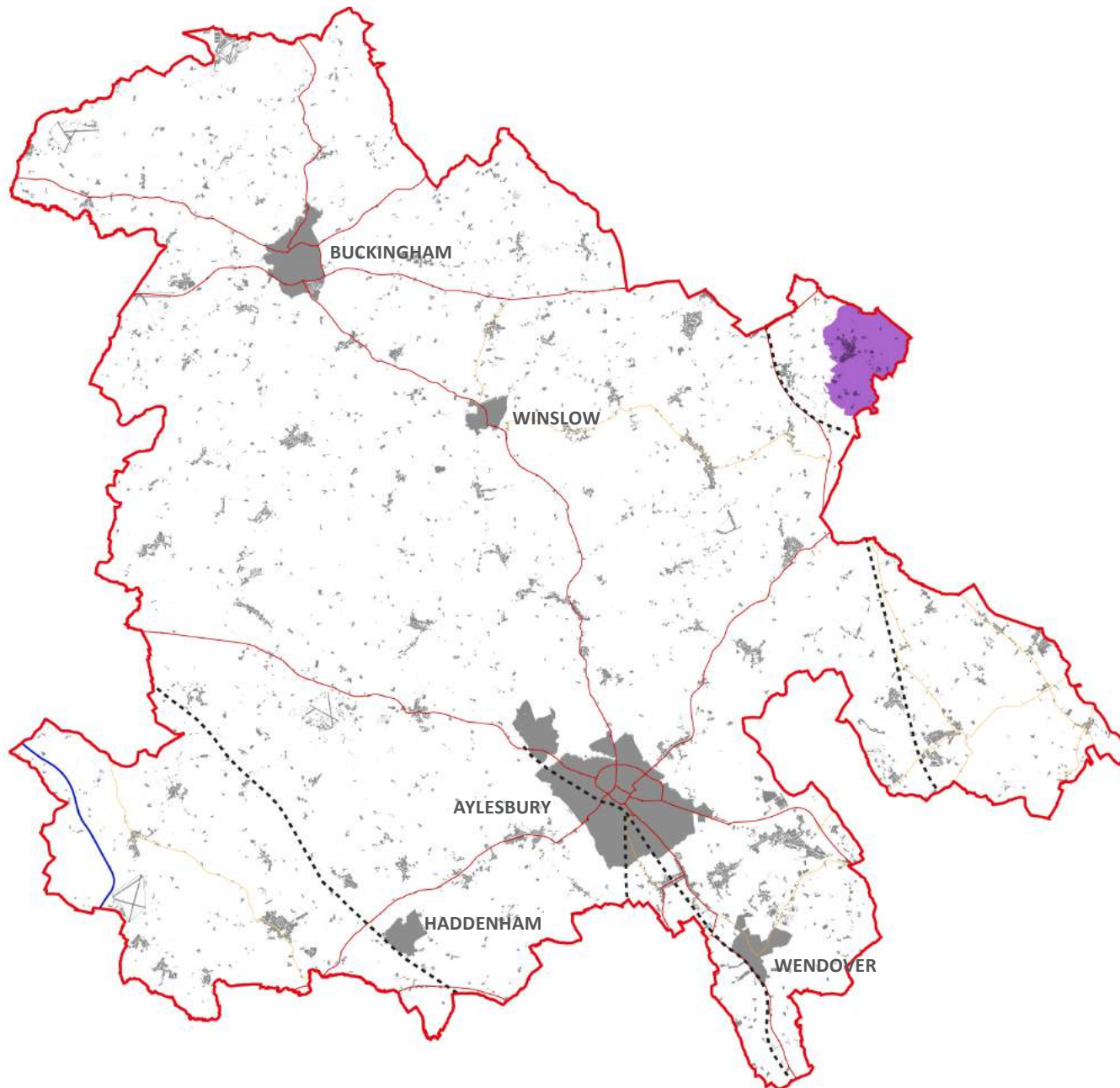

Typology	LCT 06: Greensand Ridge
<b>Landform and views</b>	A distinct wooded scarp which has been eroded into an undulating landform, creating steep valleys and small promontories. Long distance views towards Milton Keynes and extensive views over the Ouzel valley.
<b>Vegetation</b>	Extensive woodland cover consists of ancient semi-natural woodland, secondary woodland and coniferous plantations. Heathland and acidic grassland habitats can also be found.
<b>Settlement and materials</b>	Narrow and winding lanes traverse up the scarp face. Building materials are typically red brick, with historic examples using mixed materials; red brick, timber, sandstone and render. Great Brickhill village occupies a section of the scarp, displaying strong local vernacular with thatched roofs, local sandstone in buildings and walls.
<b>Settlements within area</b>	Medium and small villages: Great Brickhill.

Figure B.6: Landscape character typology LCT06: Greensand Ridge

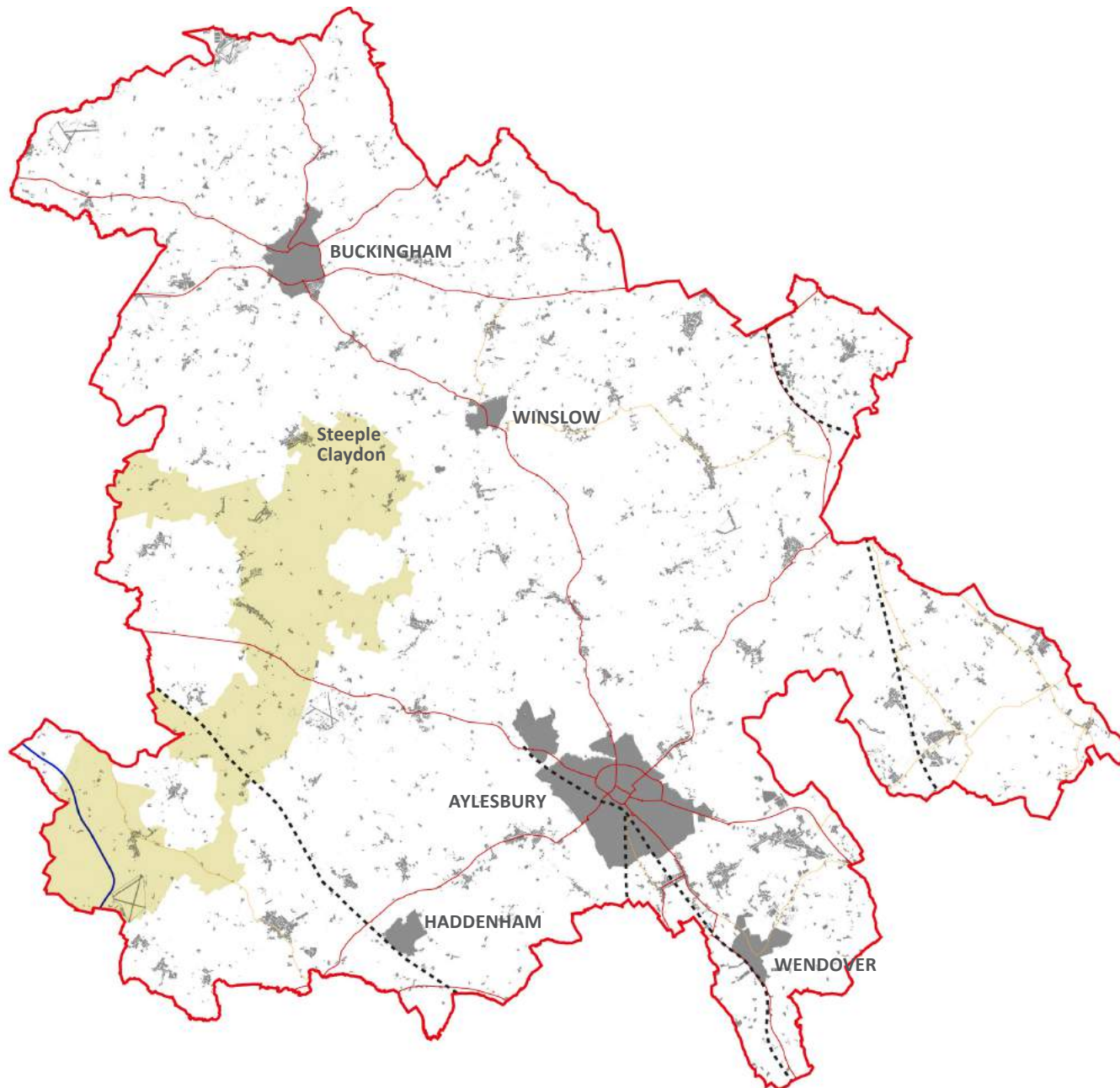

Typology	LCT 07: Wooded Rolling Lowlands
<b>Landform and views</b>	An undulating clay landscape populated with small ridges and hills. Views to the Chilterns from the south of the LCT however a well wooded and treed landscape limits views The M40 corridor is a visual detractor.
<b>Vegetation</b>	The dominant grassland coverage is interspersed with large blocks of ancient woodland. A strong hedgerow pattern with mature oaks, whilst poorly drained soil is often scrub.
<b>Settlement and materials</b>	Low density, historic settlement and its associated enclosure is focused along ridgelines, creating a tranquil character, enhanced by meandering lanes and low-intensity farming. Building materials are typically red brick, with historic examples using mixed materials; thatched roofs, red brick, timber, sandstone and render.
<b>Settlements within area</b>	Large Villages: Steeple Claydon (south). Medium and small villages: Calvert Green, Charndon, East Claydon, Grendon Underwood, Oakley and Steeple Claydon (south).

Figure B.7: Landscape character typology LCT07: Wooded Rolling Lowlands

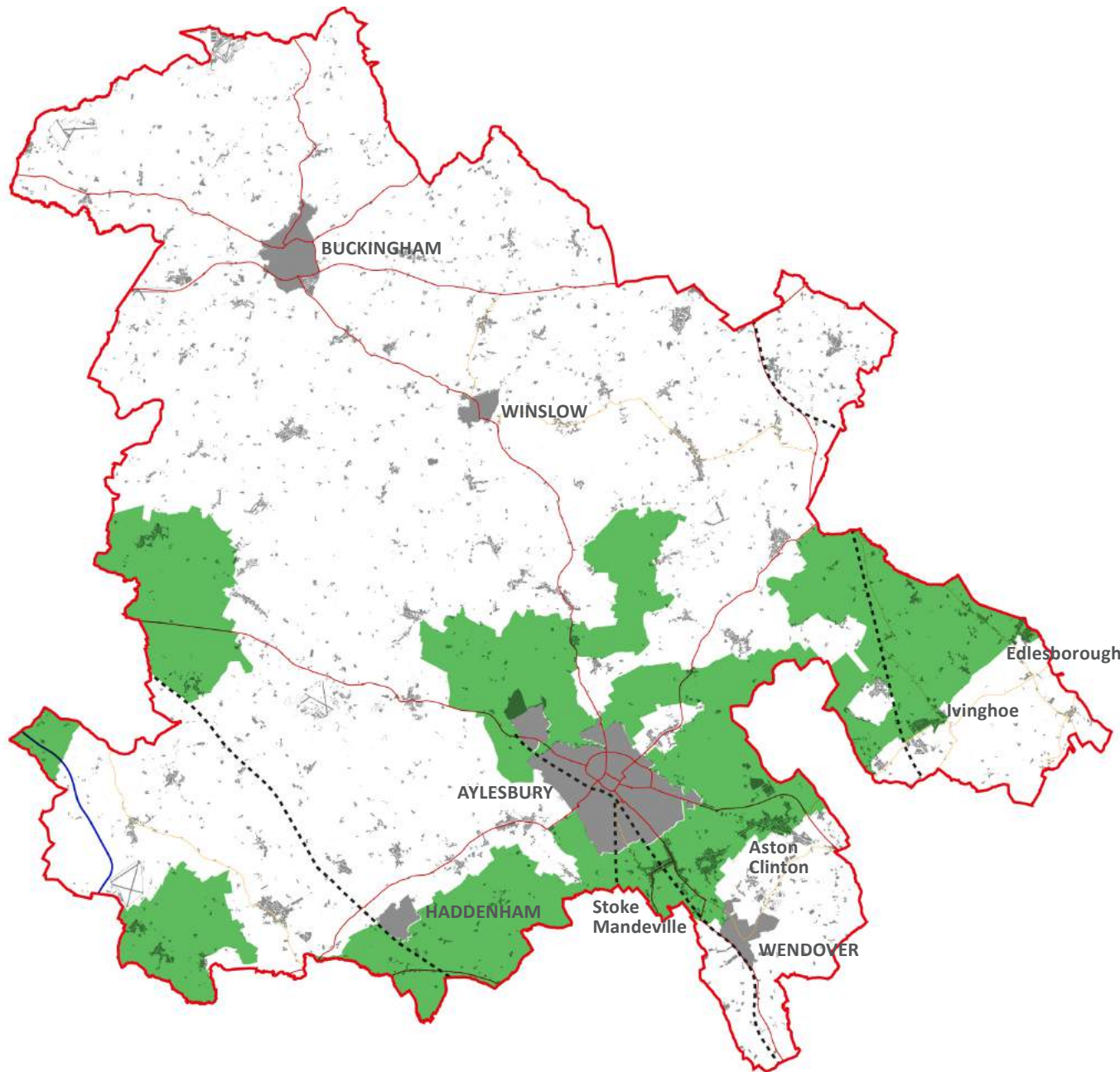

Typology	LCT 08: Vale
<b>Landform and views</b>	Poorly drained, low-lying and flat landscape with an eroded shallow limestone ridge creating isolated fragments of higher ground. Extensive views available from the fringes of the LCT.
<b>Vegetation</b>	Intricate network of watercourses, including River Thames, are distinctively lined with mature black poplar trees. Surrounding agricultural grassland with mosaic of wet, species-rich habitats.
<b>Settlement and materials</b>	Roads radiating from central Aylesbury cross the Vale landscape, creating linear settlement patterns. Areas to the north and east are sparsely populated, therefore retaining a sense of remoteness. Historic materials displayed are mixed, typically red brick, limestone, timber, witchert, limestone and/or render.
<b>Settlements within area</b>	<p>Towns: Aylesbury and Haddenham (southern edge).</p> <p>Large villages: Aston Clinton (west), Edlesborough, Ivinghoe and Stoke Mandeville.</p> <p>Medium and small villages: Buckland, Ford, Hardwick, Ickford, Ivinghoe Aston, Ludgershall, Marsh Gibbon, Mentmore and Ledburn, Northall, Shabbington, Slapton, Weston Turville and Worminghall.</p>

Figure B.8: Landscape character typology LCT08: Vale

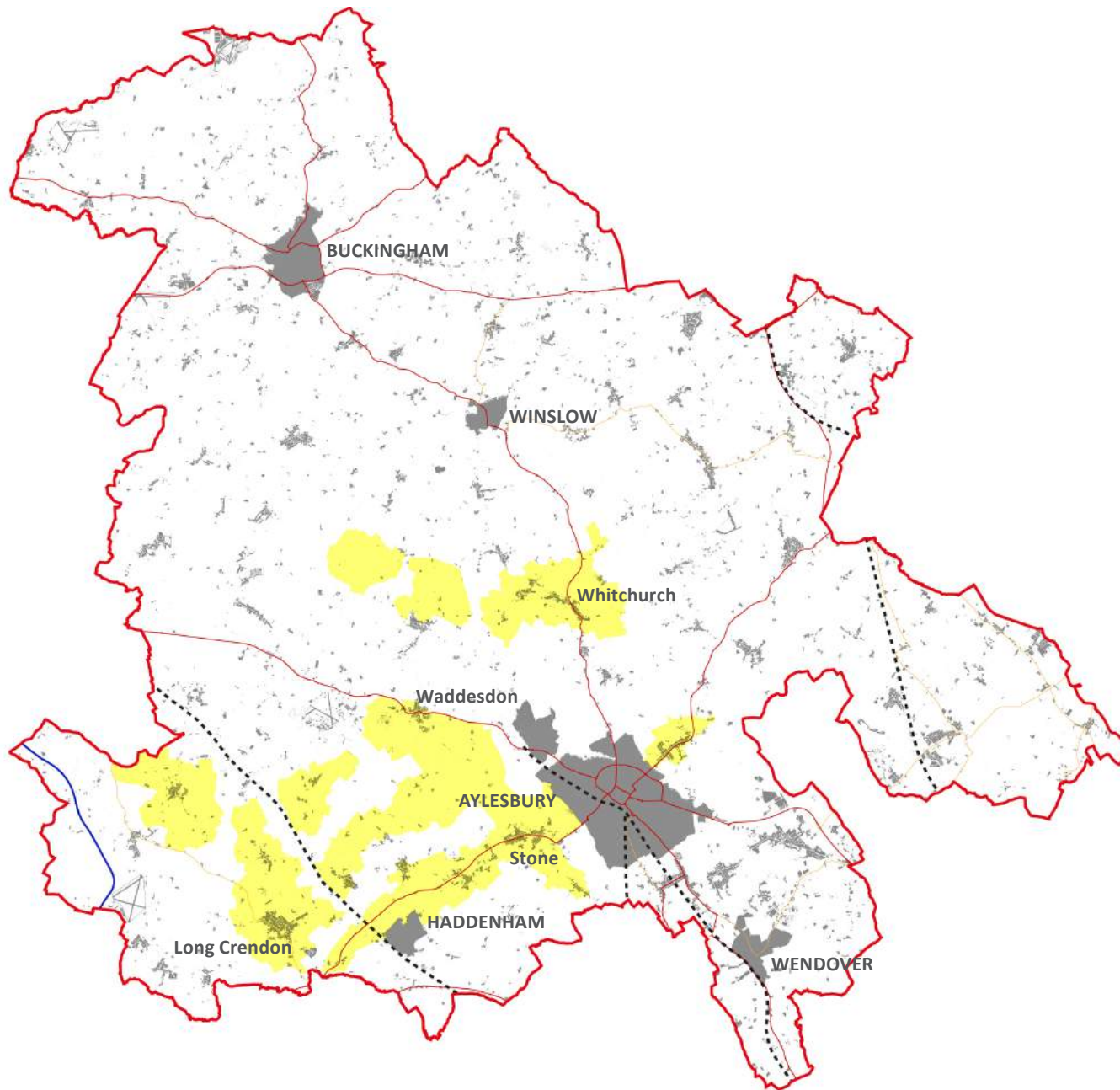

Typology	LCT 09: Low Hills and Ridges
Landform and views	Narrow ridges and small, steep hills create a distinctive landscape. Dramatic views are a major feature of the type, over both surrounding lower ground and towards the Chilterns.
Vegetation	Grassland provides the dominant vegetative cover and largely intact hedgerows are populated with ash. The low density of woodland is interspersed with blocks of ancient woodland. Mature and veteran trees indicate designed estate parklands.
Settlement and materials	Settlement consisting of limestone villages is mostly limited to ridges or hill tops, via narrow, sometimes sunken lanes. Strong historic landscapes surrounding villages and estates of Waddesdon, Eythrope and Hartwell. Witchert walls can be found on occasional houses and garden walls.
Settlements within area	<p>Towns: Aylesbury (west and east) and Haddenham (northern edge).</p> <p>Large villages: Long Crendon, Stone (including Hartwell), Waddesdon (including Fleet Marston) and Whitchurch.</p> <p>Medium and small villages: Ashendon, Bierton (including Broughton), Bishopstone, Brill, Chearsley, Chilton, Cuddington, Dinton and Oving (including Pitchcott).</p>

Figure B.9: Landscape character typology LCT09: Low Hills and Ridges

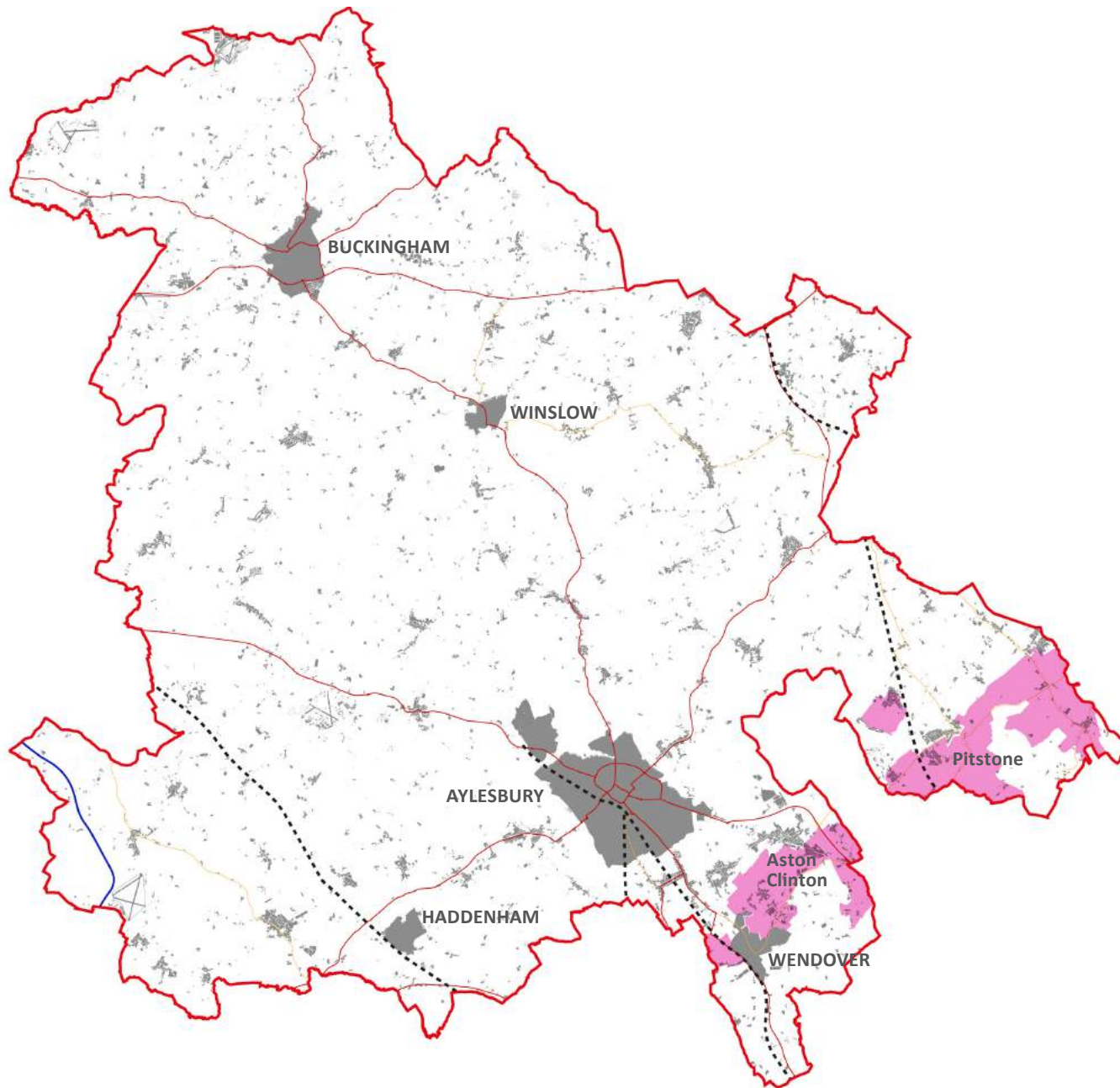

Typology	LCT 10: Chalk Foothills
Landform and views	Rolling chalk hills providing a between the lowlands and the chalk escarpment of the Chilterns, with transport and communication corridors in the valley bottoms. Views are generally contained by topography.
Vegetation	Lower slopes of the foothills are dominated by large arable fields. As elevation increases so does the mixture of farming, and increased frequency of scattered broadleaved woodland.
Settlement and materials	Settlement varies from sparse to extensive, typically nucleated villages. Remnants of restored chalk quarries alongside areas of commercial, light industrial and residential redevelopment.
Settlements within area	Towns: Wendover/Halton Camp (west and east). Large villages: Aston Clinton (east) and Pitstone. Medium and small villages: Cheddington, Dagnall, Halton, and Marsworth.

Figure B.10: Landscape character typology LCT10: Chalk Foothills

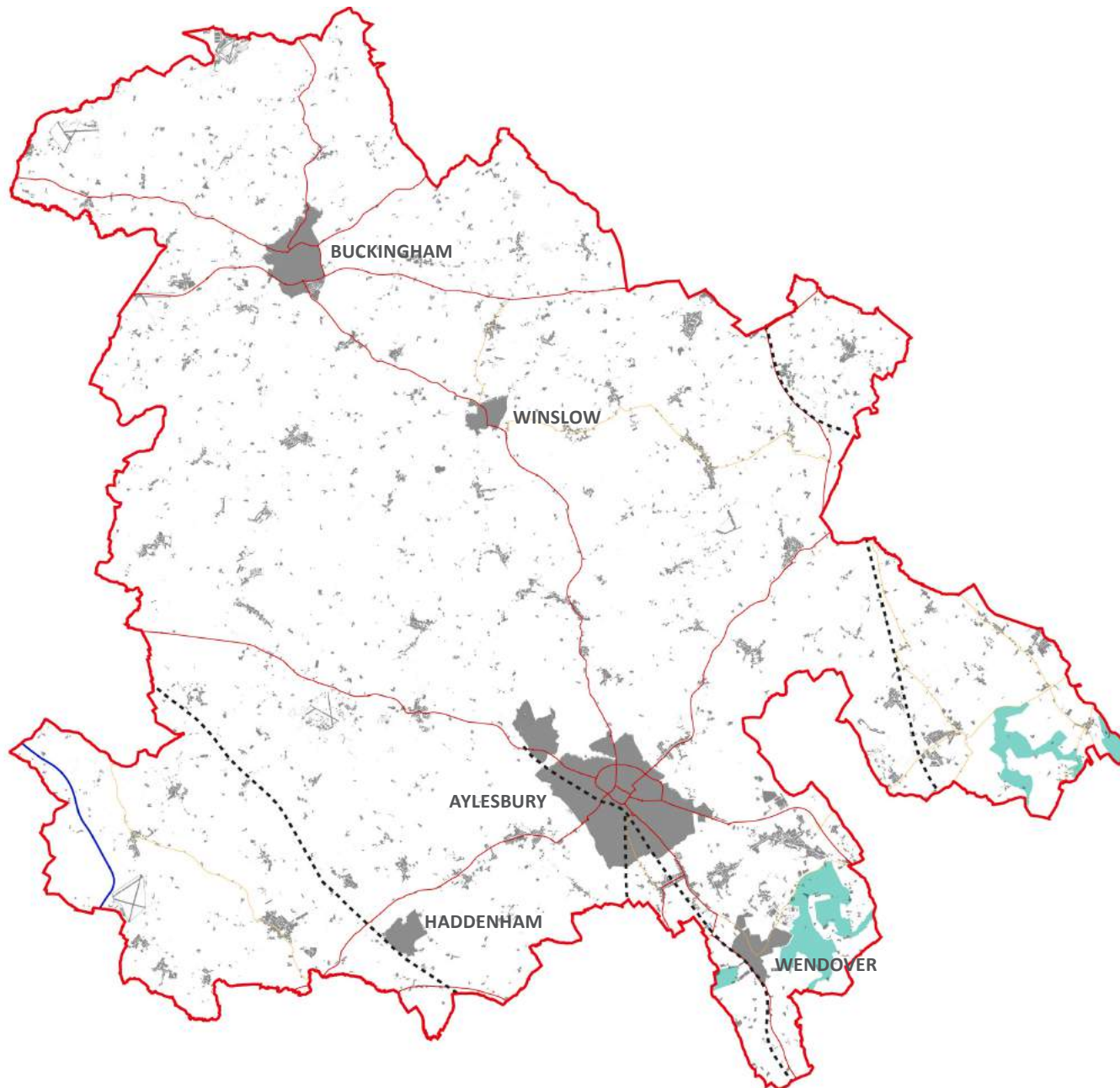

Typology	LCT 11: Chalk Escarpment
Landform and views	Steeply sloped Chiltern scarp which has been eroded to create a network of dry valleys and promontories. Panoramic views are available across the Vale and fringes of Milton Keynes, reflecting its designation as an AONB.
Vegetation	Poorly drained soil with extensive beech, oak and birch woodlands transition to beech 'hangers' on steep slopes. Wych elm and ash are found on the steepest slopes, and hawthorn, juniper and hazel coppice provide increased biodiversity.
Settlement and materials	A sparsely populated type with chalk promontories being the focus of historic fortified development and earthworks. This is reflected in the number of Scheduled Monuments within the LCT.
Settlements within area	N/A

Figure B.11: Landscape character typology LCT11: Chalk Escarpment

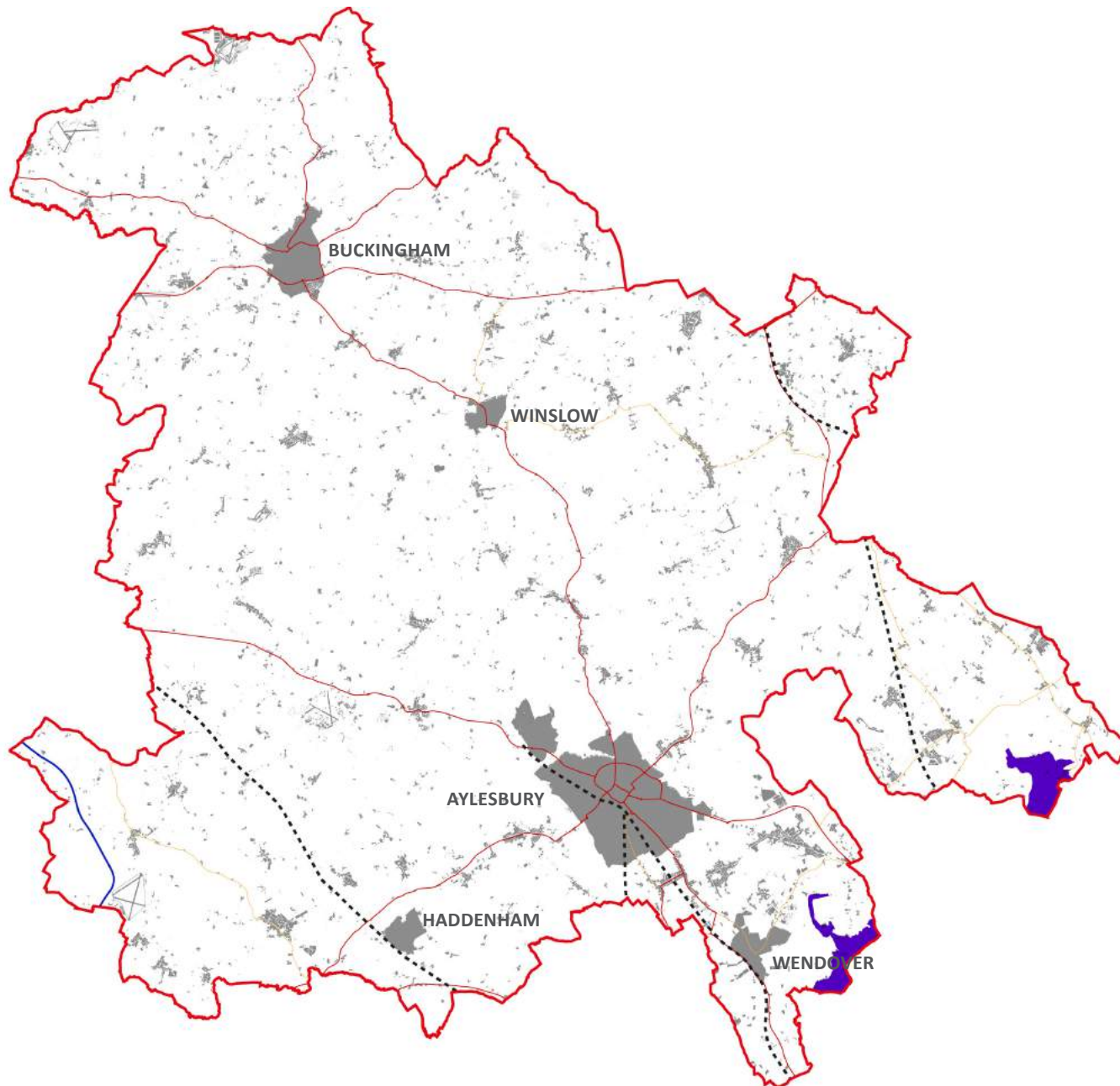

Typology	LCT 12: Chalk Dip Slopes
Landform and views	A gentle dip slope providing a transition between the steep scarp to the north and the chalk plateau in the south. Excellent views can be had, making the LCT popular for recreation.
Vegetation	Biodiverse chalk downland and extensive and diverse ancient semi-natural woodland cover reflects traditional management through clearance and grazing. Former common land has now developed into secondary woodland.
Settlement and materials	Settlement within the dip slope is sparse, reflected in the narrow lanes and isolated typically red brick farmsteads. Use for recreation is evident through the prevalence of public access, car parks and long distance footpaths.
Settlements within area	N/A

Figure B.12: Landscape character typology LCT12: Chalk Dip Slopes

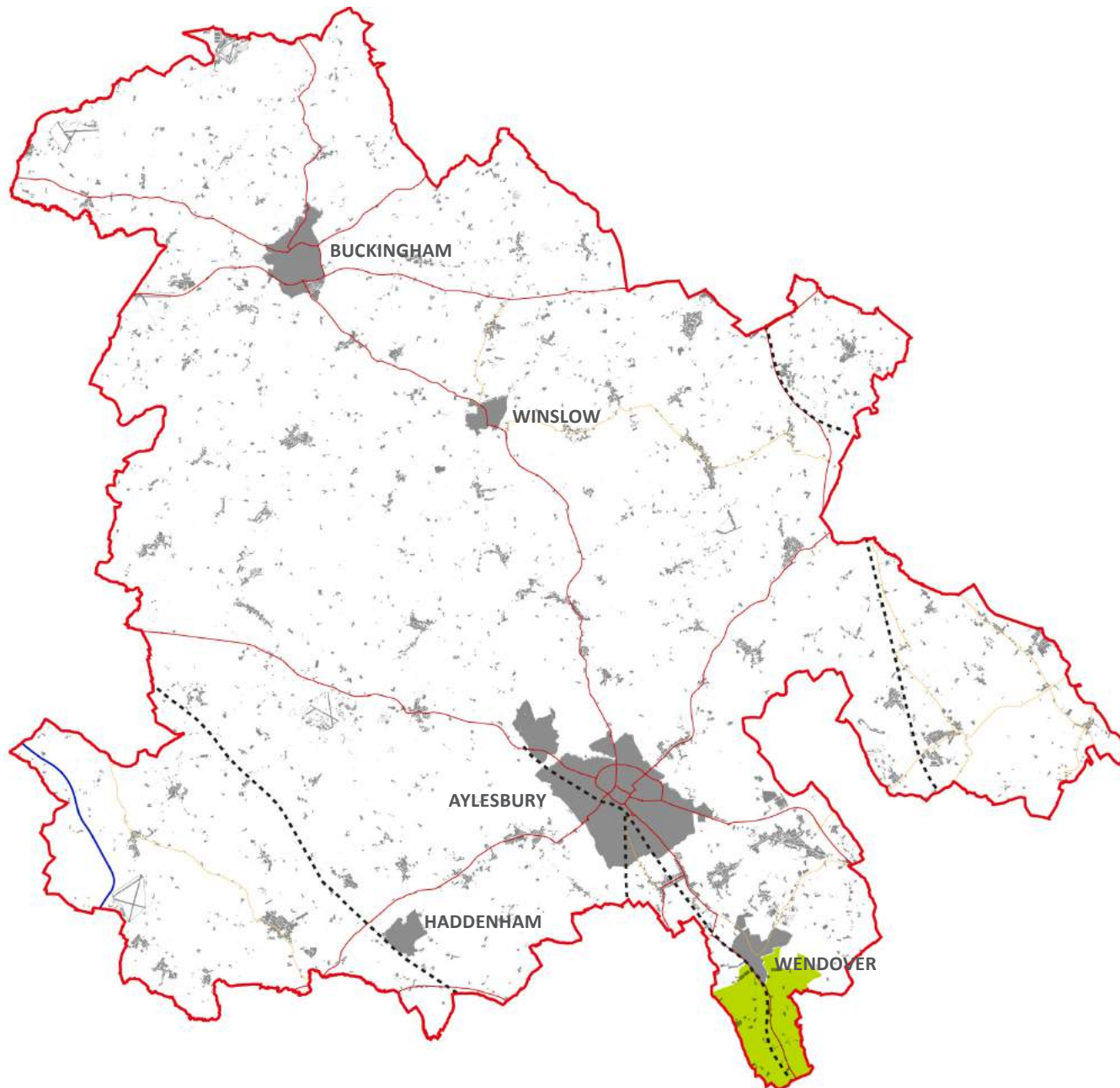

Typology	LCT 13: Chalk Valleys
Landform and views	Steep-sided, dry chalk valley which incises the Chilterns scarp. Transport and electrical corridors connecting the Vale to London, as well as pylons, lie in the valley bottom. Panoramic views across the valley are available at local vantage points.
Vegetation	The valley floor is characterised by large open fields with well-maintained hedges or linear tree belts. Valley sides are characterised by small blocks of calcareous beech woodland 'hangers' and ancient woodland, with upper slopes enclosed by narrow woodland belts.
Settlement and materials	Concentrations of settlement generally occur as ribbon developments along main road corridors, the A413 or within the town of Wendover. Smaller settlements and farmsteads can be found on the valley sides with materials in historic buildings typically with mixed red brick and flint panels, mixed coloured bricks, and occasional hung tile panels.
Settlements within area	N/A

Figure B.13: Landscape character typology LCT13: Chalk Valleys



# Appendix C

## Glossary



**Accessibility** - The ability of people to move around an area and to reach places and facilities, including elderly and disabled people, and those with young children.

**Active frontage** - Refers to street frontages where there is an active visual engagement between those in the street and those on the ground and upper floors of buildings.

**Building line** - The line formed by the frontages of buildings along a street or space.

**Bulk** - The combined effect of the arrangement, volume and shape of a building or group of buildings. Also called massing.

**Character assessment** - An area appraisal identifying distinguishing physical features and emphasising historical and cultural associations.

**Coarse grain** – refer to urban grain – the areas pattern is coarse grain where the street blocks, street junctions and spaces between buildings tend to be large.

**Context** - The setting of a site or area, including factors such as traffic, activities and land uses as well as landscape and built form.

**Defensible space** – Space around a building that is defensible in the sense that it is surveyed, demarcated and maintained by somebody.

**Density** - The floorspace of a building or buildings or some other unit measure in relation to a given area of land. Built density is expressed in number of dwellings per hectare (for residential development) in this guide.

**Desire line** - An imaginary line directly linking facilities or places which people find convenient to travel between easily.

**Distinctiveness** - The positive features of a place and its communities which contribute to its special character and sense of place

**Elevation** - The facade of a building, or the drawing of a façade.

**Enclosure** - The use of buildings to create a sense of defined space.

**Fenestration** - The arrangement of windows on a facade.

**Fine grain** - refer to urban grain – the areas pattern is fine grain where the streets and spaces are tight knit and feature narrower building frontages, smaller blocks and more frequent junctions.

**Human scale** - Development which relates well in size and design to an individual human being and is assembled in a way which makes people feel comfortable rather than overwhelmed.

**Landmark** - A building or physical feature that stands out from its background by virtue of height, size or some other aspect of design.

**Layout** - The way buildings, routes and open spaces are placed in relation to each other.

**Legibility** - The degree to which a place can be easily understood and navigated.

**Massing** - The combined effect of the height, bulk and silhouette of a building or group of buildings.

**Natural surveillance** - The discouragement of anti-social activity by the presence of passers-by or the ability of people to be seen out of surrounding windows. Also known as passive surveillance.

**Node** - A place where activity and routes are concentrated often used as a synonym for junction.

**Permeability** - The degree to which an area has a variety of pleasant, convenient and safe routes through it.

**Public art** - Permanent or temporary physical work of art visible to the general public, whether part of a building or free-standing: can include sculpture, lighting effects, street furniture, paving, railings and signs.

**Public realm** - The parts of a village, town or city (whether publicly or privately owned) that are available, without charge, for everyone to use or see, including streets, squares and parks.

**Scale** - The impression of a building when seen in relation to its surroundings, or the size of parts of a building or its details, particularly as experienced in relation to the size of a person (also refer to 'human scale'). Sometimes it is the total dimensions of a building which give it its sense of scale; at other times it is the size of the elements and the way they are combined.

**Settlement pattern** - The distinctive way that the roads, paths and buildings are laid out in a particular place.

**Sight line** - Lines of clear, uninterrupted sight from a viewer's location to other locations and distances.

**Strategic view** - The line of sight from a particular point to an important landmark or skyline.

**Street furniture** - Structures in and adjacent to the highway which contribute to the streetscape, such as bus shelters, litter bins, seating, lighting, railings and signs.

**Streetscape** - The visual character of a street space that results from the combination of street width, curvature, paving, street furniture, plantings and the surrounding built form and detail. The people and activities present in the street also contribute to the streetscape.

**Sustainability** - Meeting the needs of the present without compromising the ability of future generations to meet their needs.

**Traffic calming** - Measures taken to slow or reduce vehicle traffic and improve safety for pedestrians and cyclists.

**Topography** - The physical shape, form and surface configuration of an area including the slope of the land and features such as rivers.

**Urban design** - The art of making places. Urban design involves the design of buildings, groups of buildings, spaces and landscapes, in villages, towns and cities, and the establishment of frameworks and processes which facilitate successful development.

**Urban grain** - The pattern of the arrangement and size of buildings and their plots in a settlement; and the degree to which an area's pattern of street-blocks and street junctions is respectively small and frequent, or large and infrequent.

**Vernacular** - The way in which ordinary buildings were built in a particular place making use of local styles, techniques and materials and responding to local economic and social conditions.

